



SCHOOL

DISTRICT

EDUCATING LEARNERS FOR THE 21ST CENTURY

REGULAR BOARD MEETING

June 29, 2022

**Rio School District
Conference Room
1800 Solar Drive
Oxnard, CA 93030**

**JOHN D. PUGLISI, Ph. D.
Superintendent**

**Board of Education
Kristine Anderson, President
Edith Martinez-Cortes, Clerk
Linda Armas
Eleanor Torres**

2.0



Wednesday, June 29, 2022
RSD Regular Board Meeting

Rio School District
1800 Solar Drive
Oxnard, CA 93030

1. Open Session 5:00 p.m.

- 1.1 Call to Order
- 1.2 Pledge of Allegiance
- 1.3 Roll Call

2. Approval of the Agenda

- 2.1 Agenda Correction, Additions, Modifications
- 2.2 Approval of the Agenda

3. Public Comment-Closed Session

3.1 Public Comment (Closed Session) The public may address the Board concerning items that are scheduled for discussion during the closed session only. These presentations are limited to three minutes each, or a total of fifteen minutes in all.

4. Closed Session

- 4.1 Public Employee Discipline/Dismissal/Release [Government Code 54957]
- 4.2 Conference with Labor Negotiators [Government Code 54957.6] Agency designated representatives: RSD Negotiating Team; Employee Organization: California School Employee's Association and Rio Teachers' Association
- 4.3 Public Employee Performance Evaluation [Government Code 54957] Title: Staffing 2022/2023 and Superintendent End of Year Evaluation

5. Reconvene Open Session 6:00 p.m.

- 5.1 Report of Closed Session

6. Communications

- 6.1 Acknowledgement of Correspondence to the Board
- 6.2 Board Member Reports
- 6.3 Organizational Reports-RTA/CSEA/Other
- 6.4 Superintendent Report
- 6.5 Public Comment-Board meetings are meetings of the Governing Board held in public and will be held in a civil, orderly and respectful manner. Persons wishing to address the Board must fill out a speaker card. Cards are available at the meeting and on the District website. Cards must be submitted to the Secretary or Clerk of the Board. A member of the public may address the Governing Board on any item(s) on the agenda or non-agenda items. Each person speaking may not exceed a total of three minutes on each item. The speaker may choose to speak during public comment or at

the time of the agenda item prior to board consideration. These presentations are limited to three minutes or a total of twenty minutes

7. Information

7.1 Educational Services Report

7.2 RSD Universal Prekindergarten Plan

8. Discussion/Action

8.1 Provisional Board Member Appointment

8.2 Resolution No. 21/22-26 of the Board of Trustees of the Rio Elementary School District Ordering a School Bond Election, Establishing Specifications of the Election Order, and Requesting Consolidation with Other Elections Occurring on November 8, 2022.

8.3 Approval of Revised Certificated Salary Schedule reflecting 5% on Salary Increase

8.4 Approval of 2022-2023 Single Plan for Student Achievement for all Nine Schools

8.5 Approval of the Local Control Accountability Plan

8.6 Adopted Budget for 2022/2023

9. Consent

9.1 Approval of the Consent Agenda

9.2 Approval of the Minutes of the Regular Board Meeting of June 22, 2022

9.3 Approval of the Personnel Report

9.4 Contract Renewal with Diane DeLaurentis to Provide Drama Instruction FY 2022/2023

9.5 Approval of Contract Renewal with Steve Sunnarborg FY 2022/2023

9.6 Approval of Service Agreement Renewal with Nee Quaison-Sackey to Provide Music Instruction FY 2022/23

9.7 Approval of Contract Renewal with Lawrence Interactive Media FY 2022/2023

9.8 Approval of the Contract Renewal with Learning Priority Software, Inc FY 22/23

9.9 Approval of the Certification of Signatures fiscal year 2022/2023

9.10 Approval of agreement with School Services of California for consulting services for 2022/2023

9.11 Approval of Contract with SAGE Realty Group for July 1, 2022 - June 30, 2023 for Consulting Services

9.12 Approval of Annual List of Pre-Qualified Bidders from Quality Bidders for 2022/2023

9.13 Approval of the 2022/2023 contract renewal with FoodCorps Service for the fourth year.

9.14 Approval of Amendment of Agreement to Child Nutrition Grocery Bid with SYSCO

9.15 Memorandum of Understanding with Oxnard Union High School District K12 Strong Workforce Program Grant Funds

9.16 Contract with Boys and Girls Club of Greater Oxnard and Port Hueneme to provide summer staffing and programs for 2022

9.17 Contract with Catalyst Kids, Inc. to provide summer PreK STEAM Camp

9.18 Lease Agreement with Catalyst Family Inc. for Preschool Services

9.19 Renewal of lease agreement with First 5 Ventura for the use of spaces in the Office of Student and Family Services

- 9.20 Approval of the Non Public School – Passageway School Contract
 - 9.21 Approval of the Contract with 360 Degrees Customer Inc. for Speech and Language Services
 - 9.22 Approval of the Contract with Soliant Health for Speech and Language Services
 - 9.23 Maxim Health Care Staffing Services Contract
 - 9.24 Approval of Ventura County Indian Education Consortium MOU
 - 9.25 Approval of the The Stepping Stones Group Contract
 - 9.26 Contract with Boys and Girls Club of Greater Oxnard and Port Hueneme for staffing of EXPLORE programs 2022-2023
 - 9.27 Approval of Center for Effective Philanthropy, Inc. (CEP) Contract
 - 9.28 Approval to Contract Renewal with Securly for Content Filtering System
 - 9.29 Contract with MICOP for Mixteco translation and outreach services 2022-2023 school
 - 9.30 Approval of Open Up Resource Workbook purchase for 2022-2023 School Year
 - 9.31 Approval of the Annual Q SIS Hosting Service Level Agreement
 - 9.32 Approval of the Taft Electric Co. Proposal for Rio Vista MPR Lighting Replacement and Upgrade
 - 9.33 Approval for Superintendent to receive and approve lowest responsive bid for Playground Structures Site Work at Rio Del Sol, Project No. 22-10L REBID
- Approval of the Contract Renewal with Hip Hop Mindset FY 2022/2023

10. Organizational Business

- 10.1 Future Items for Discussion
- 10.2 Future Meeting Dates: August 17, 2022

11. Adjournment

- 11.1 Adjournment

4.1



Agenda Item Details

Meeting	Jun 29, 2022 - RSD Regular Board Meeting
Category	4. Closed Session
Subject	4.1 Public Employee Discipline/Dismissal/Release [Government Code 54957]
Access	Public
Type	Discussion

Public Content

Speaker: John Puglisi, Ph.D., Superintendent

Rationale:

Staff will update and discuss with the Governing Board.

Administrative Content

Executive Content

4.2

**Agenda Item Details**

Meeting	Jun 29, 2022 - RSD Regular Board Meeting
Category	4. Closed Session
Subject	4.2 Conference with Labor Negotiators [Government Code 54957.6] Agency designated representatives: RSD Negotiating Team; Employee Organization: California School Employee's Association and Rio Teachers' Association
Access	Public
Type	Discussion

Public Content

Speaker: John Puglisi, Ph.D., Superintendent

Rationale:

The Governing Board will discuss Conference with Labor Negotiators [Government Code 54957.6] Agency designated representatives: RSD Negotiating Team; Employee Organization: California School Employee's Association and Rio Teachers' Association.

Administrative Content**Executive Content**

4.3



Agenda Item Details

Meeting Jun 29, 2022 - RSD Regular Board Meeting

Category 4. Closed Session

Subject 4.3 Public Employee Performance Evaluation [Government Code 54957] Title: Staffing 2022/2023 and Superintendent End of Year Evaluation

Access Public

Type Discussion

Public Content

Speaker:

Rationale:

Administrative Content

Executive Content

6.4



Agenda Item Details

Meeting	Jun 29, 2022 - RSD Regular Board Meeting
Category	6. Communications
Subject	6.4 Superintendent Report
Access	Public
Type	Procedural

Public Content

Speaker: John Puglisi, Ph.D., Superintendent

Rationale:

Superintendent Puglisi will update the Governing Board on the following:

- Summer Update

Administrative Content

Executive Content

7.1



Agenda Item Details

Meeting	Jun 29, 2022 - RSD Regular Board Meeting
Category	7. Information
Subject	7.1 Educational Services Report
Access	Public
Type	Information
Goals	<p>Goal 3-Create welcoming and safe environments where students attend and are connected to their school</p> <p>Goal 4-Prepare students to be college and career ready through technology and innovation that facilitates collaboration, creativity, critical thinking and communication.</p> <p>Goal 5-Recruit, hire, train, and retain exemplary employees who are caring, committed, collaborative, creative and critical thinkers.</p> <p>Goal 1-Improved student achievement at every school and every grade in all content areas</p> <p>Goal 2-Engage parents and other District stakeholders in the development of meaningful partnerships to support student learning.</p>

Public Content

Speaker: Oscar Hernandez, Assistant Superintendent of Educational Services

Rationale: Educational Staff will provide the Governing Board with the following updates:

- LCAP Update
- Parent Involvement and Opportunities for Parents for the coming year

Administrative Content

Executive Content

7.2



Agenda Item Details

Meeting	Jun 29, 2022 - RSD Regular Board Meeting
Category	7. Information
Subject	7.2 RSD Universal Prekindergarten Plan
Access	Public
Type	Information
Goals	<p>Goal 1-Improved student achievement at every school and every grade in all content areas</p> <p>Goal 3-Create welcoming and safe environments where students attend and are connected to their school</p> <p>Goal 4-Prepare students to be college and career ready through technology and innovation that facilitates collaboration, creativity, critical thinking and communication.</p>

Public Content

Speaker: Oscar Hernandez, Assistant Superintendent Educational Services

Rationale:

Under the provisions of California Education Code (EC) Section 8281.5, grant funds are allocated to school district, charter schools, and county office of education (COEs) with kindergarten enrollment in specific years, according to a specified formula.

As a condition of receiving grant funds, state law requires each LEA to create a plan articulating, how all children in the attendance area of the LEA will have access to full-day learning programs the year before kindergarten that meet the needs of parent, including through partnerships with the LEA's expanded learning offerings, the After-School Education and Safety Program, the California state preschool program, Head Start programs, and other community-based early learning and care programs (EC Section 8281.5).

2021_UPK_Planning_and_Implementation_Grant_Program_Rio_School_District_20220615.pdf (204 KB)

Administrative Content

Executive Content

Universal Prekindergarten Planning and Implementation Grant Program – Planning Template

A Resource for Local Educational Agencies
Released – December 17, 2021

Universal Prekindergarten in California.....	3
The California Universal Prekindergarten Planning and Implementation Grant Program – Overview	3
Planning Template Purpose.....	4
Accompanying Guidance	5
Directions, Timeline, and Suggested Planning Process	5
Key Considerations	6
Transitional Kindergarten Implementation Timeline	6
Supporting a Preschool through Third Grade Continuum	7
Full-Day, Extended Learning and Care.....	7
Creating Joint or Aligned Plans	8
UPK Planning Template	9
Self-Certification	9
Projected Enrollment and Needs Assessment.....	10
Recommended Planning Questions.....	10
Required Questions	11
Focus Area A: Vision and Coherence	12
Recommended Planning Questions.....	12
Required Questions	14
Focus Area B: Community Engagement and Partnerships	16
Recommended Planning Questions.....	16
Required Questions	17
Focus Area C: Workforce Recruitment and Professional Learning.....	19
Recommended Planning Questions.....	19
Required Questions	20
Focus Area D: Curriculum, Instruction, and Assessment.....	22
Recommended Planning Questions.....	22
Required Questions	22
Focus Area E: LEA Facilities, Services, and Operations	24
Recommended Planning Questions.....	24
Required Questions	24
Technical Assistance Questions	27
Appendix I - Definitions	30

Appendix II - Additional Deeper Planning Questions32
 Focus Area A: Vision and Coherence32
 Focus Area C: Workforce Recruitment and Professional Learning.....32
 Focus Area D: Curriculum, Instruction, and Assessment.....32
 Focus Area E: LEA Facilities, Services, and Operations33

Universal Prekindergarten in California

Decades of research demonstrate that an early and strong foundation for learning matters. Children who have effective learning opportunities before kindergarten have an advantage in school and in life over children who do not, especially children with adverse childhood experiences. Children who attend quality preschool programs are more prepared for school in terms of their early literacy, language, and math skills, their executive function, and social emotional development. In some cases, preschool participants are less likely to be identified for special education services or to be held back in elementary school than children who do not attend developmentally-informed preschool programs that include strong educational components.

California is poised to realize universal prekindergarten (UPK) for all four-year-old children, and to expand services for three-year-old children through bold leadership and the unprecedented investments in the Budget Act of 2021, including universal transitional kindergarten (UTK) and expansion of the California State Preschool Program (CSPP).

The tumult of the COVID-19 pandemic accelerated a call to action to ensure a strong educational foundation for all children, emphasizing the critical role of our education system in supporting children and families' needs and how local flexibility fuels community capacity to meet their needs. California's leaders responded with historic investments in family support, child development and care, and education. Yet, as the Master Plan for Early Learning and Care highlights, realizing the promise of early childhood investments will require all partners—across early learning and care, early education, elementary education, and expanded learning and extended care communities—to work together to create a stronger system designed to meet the needs of the whole child.

The California Universal Prekindergarten Planning and Implementation Grant Program – Overview

California seeks to set children on a trajectory of lifelong success by investing in early and equitable learning experiences, including infant and toddler supports, such as family leave and access to infant and toddler care, universal preschool for all four-year-old children, and enhanced educational experiences across an aligned preschool to third grade system.

The 2021–22 State Budget package established the UPK Planning and Implementation Grant Program as a state early learning initiative with the goal of expanding access to prekindergarten programs at local educational agencies (LEAs). This grant program provides \$200 million for the California Department of Education (CDE) to allocate directly to LEAs based on a statutory formula to support planning and implementation costs associated with expanding prekindergarten options, such as universally-available transitional kindergarten (TK), CSPP, and Head Start for eligible students, and other local and community-based partnerships. It is important for LEAs to include partners such as CSPP, Head Start, and other early learning and care providers in the co-creation of the local plan. Engaging all partners in the community will enhance resources for families and children and fully utilize and coordinate available resources, including facilities, staff, and funding.

Under the provisions of California Education Code (EC) Section 8281.5, grant funds are allocated to school districts, charter schools, and county offices of education (COEs) with kindergarten enrollment in specific years, according to a specified formula. In addition, funds are allocated to COEs to support countywide planning and capacity building around UPK.

Grant funds may be used for costs associated with creating or expanding CSPP or TK programs, or to establish or strengthen partnerships with other providers of prekindergarten education within the LEA, including Head Start programs, to ensure that high-quality options for prekindergarten education are available for four-year-old children. Allowable costs include, but are not limited to: (1) planning costs, (2) hiring and recruitment costs, (3) staff training and professional development, (4) classroom materials, and (5) supplies.

As a condition of receiving grant funds, state law requires each LEA to create a plan articulating,

how all children in the attendance area of the LEA will have access to full-day learning programs the year before kindergarten that meet the needs of parents, including through partnerships with the LEA's expanded learning offerings, the After-School Education and Safety Program, the California state preschool program, Head Start programs, and other community-based early learning and care programs (EC Section 8281.5).

Under state law, the plan must be developed for consideration by the LEA's governing board or body at a public meeting on or before June 30, 2022, after which the LEA must provide data, as specified by the State Superintendent of Public Instruction, to the CDE. The CDE must encumber funds by June 30, 2024. LEAs will have until June 30, 2025, to use the funds.

In addition, the 2021–22 State Budget also established the Expanded Learning Opportunities Program (ELO-P). The intent of the program is that all LEAs offer all unduplicated students in classroom-based instructional programs access to comprehensive afterschool and intersessional expanded learning opportunities. The ELO-P requires LEAs to offer in-person before or after-school expanded learning opportunities that, when added to the core instructional day, are no fewer than nine hours of combined instructional time and expanded learning opportunities per instructional day (EC Section 46120).

In 2021–22, all LEAs must offer all TK through sixth grade (TK–6) classroom-based, unduplicated pupils an ELO-P and provide access to 50 percent of TK–6 enrolled, classroom-based, unduplicated pupils. Commencing in 2022–23, as a condition of apportionment, LEAs with an Unduplicated Pupil Percentage (UPP) at or above 80 percent must offer an ELO-P to all TK–6 classroom-based pupils and provide access to all TK–6 classroom-based pupils upon parent or guardian request. LEAs with an UPP below 80 percent must offer an expanded learning opportunity to all TK–6 classroom-based, unduplicated pupils and provide access to 50 percent of TK–6 enrolled classroom-based, unduplicated pupils. LEAs receiving ELO-P funding must meet all TK–6 requirements, which include, but are not limited to, offering a minimum of a nine-hour day for students TK–6 during the school year, providing pupil access, and offering 30 non-school days of programming, such as during summer and intersession periods.

Summer and intersession programming are also offered through many other early learning programs such as CSPP, Head Start, and early learning and care providers. Sharing costs, staff, and resources can support implementation of TK that provides for full-day supports while also meeting parental needs and supporting parental choice of program and setting type. LEAs should consider how these services will be offered as part of their UPK Plan. For key definitions related to UPK in California, see Appendix I.

Planning Template Purpose

The UPK Planning Template has been created to: (1) offer planning questions for LEA consideration in developing comprehensive plans for UPK that meet community and family needs, and (2) outline the data that will be required for submission to the CDE to meet the requirements of EC Section 8281.5.

This template includes recommended and required planning questions. Collectively, the recommended and required questions form a set of core planning questions the CDE believes are critical to supporting the development of a comprehensive, responsive, and community-centered UPK Plan.

- Recommended Questions: LEAs are highly encouraged to incorporate answers to these questions in their UPK Plans. Responses to these questions are not required for submission to the CDE but do support more holistic planning that meets the intent of these funds.
- Required questions: LEAs will be required to answer the required data questions outlined in this template in a survey that will be issued by the CDE following the June 30, 2022, deadline for LEAs to present their plans to their governing boards.

The CDE will be collecting information on the answers to the required questions after July 30, 2022, in a survey. This will allow the CDE to learn about how LEAs are planning to implement UPK, and to identify what additional support may be needed to help LEAs as they move along the implementation process.

The questions required for submission to the CDE should be answered based on what the LEA plans to implement in the 2022–23 school year. However, the CDE encourages that LEAs, when developing their UPK Plan for consideration by their local governing board, look beyond the first year of implementation and lay the foundation for the full implementation period. The CDE also encourages LEAs to look to their Local Control and Accountability Plans (LCAPs) to identify where their LCAPs already include relevant opportunities for alignment, and to consider the results of the UPK planning and implementation efforts as it pertains to future updates to their LCAPs.

The UPK Planning Template is organized as follows:

1. Self-Certification
2. Projected Enrollment and Needs Assessment
3. Focus Area Planning
 - a. Vision and Coherence
 - b. Community Engagement and Partnerships
 - c. Workforce Recruitment and Professional Learning
 - d. Curriculum, Instruction, and Assessment
 - e. LEA Facilities, Services, and Operations
4. Technical Assistance Questions

The CDE encourages COEs to use this template as a guide for developing their own plans for how they will support the districts in their county to assess options, make decisions, and construct a plan that includes the required questions and considers the recommended questions found in this template.

Accompanying Guidance

To help introduce LEA leaders to early education concepts, agencies, and structures, the CDE will release an accompanying Guidance Document in early 2022, that will include information on the following:

1. Local LEA indirect service agencies and partners (for example, child care local planning council [LPC], Resource and Referral program [R&R], Alternative Payment Program [APP]);
2. Allowable ways to layer funding sources and programs to achieve full-day programming for four-year-old children;
3. Requirements for TK and early education facilities;
4. UPK workforce requirements for CSPP and TK educators, including the Early Learning Career Lattice, Commission on Teacher Credentialing (CTC) Child Development Teacher Permit information, information on the Multiple Subject Teaching Credential requirements, and TK educator professional learning;
5. Other available resources for UPK Implementation:
 - a. Workforce development grants and funds that can be accessed to help candidates obtain early education and TK qualifications (for example, federal stimulus funds, Educator Effectiveness Block Grant, and others);
 - b. Funding sources that can be utilized for facilities;
 - c. Funding sources that can be utilized for extended learning and care;
6. Research on the importance of participating in quality early education and research demonstrating the long-term impact on attendance, behavior, graduation rates, and academic and career success; and
7. Other resources aligned with the questions presented in the UPK Planning Template.

Additionally, the CDE will work with partners to ensure the release of additional information and technical assistance in the form of guidance, resources, tools, and regularly-scheduled webinars. Topics will include workforce, support for multilingual learners, and inclusive early education practices, among others.

Directions, Timeline, and Suggested Planning Process

LEAs are encouraged to use this template to fulfill the EC Section 8281.5 requirement to create a UPK Plan that articulates how the LEA will facilitate access to full-day learning for all children the year before kindergarten, including their partnerships with CSPP, Head Start, other preschool partners, and extended learning and care partners. The CDE will

disseminate a survey to collect responses to the required questions in this template following the June 30, 2022, deadline for presenting plans to the local governing board.

The CDE recommends the following process and timeline after the release of this UPK Planning Template in December 2021:

1. LEAs convene a planning team, including staff from the early learning department and Head Start (if these exist), curriculum and instruction, student programs, workforce and human resources (HR), business services, special education, multilingual education, expanded and after-school learning, and facilities.
2. The CDE, along with partners, will release guidance, resources, and additional information to support LEAs in the development of their UPK plan. LEAs should review this guidance as part of their planning process, and COEs should use the guidance to inform the support they offer to LEAs.
3. COEs develop plans for how they will support LEAs in their county to assess options, make decisions, and construct plans that address the required questions and consider the recommended questions found in this template. COEs should communicate with the LEAs in their county about the types of information, resources, and technical assistance the COE is able to offer to support the UPK planning process.
4. LEAs conduct outreach and engagement activities with local R&Rs, LPCs, and existing extended learning and care providers including early learning and child care providers operating within the LEA's enrollment attendance boundary.
5. LEAs convene a public engagement process to gather input and perspectives to inform the plan. This engagement process should include parents, early learning communities (including CSPP, Head Start, and the Head Start Policy Council), and expanded learning communities (including the After-School Education and Safety [ASES] Program). To ensure meaningful engagement, the CDE recommends LEAs complete this by March 1, 2022.
6. If the LEA wants technical assistance from their COE, the CDE recommends LEAs submit a draft of the UPK Plan to their COE for review by April 15, 2022.
7. Planning teams meet with the COE to discuss the LEA's draft, including local constituency input, by June 1, 2022.
8. Planning teams present a draft plan to the school board by June 30, 2022.
9. The plan shall demonstrate how families will have access to full-day learning programs the year before kindergarten that meet the needs of parents, including through partnerships with the LEA's expanded learning offerings, the ASES Program, CSPP, Head Start programs, and other community-based early learning and care programs.

Following the presentation of the plan to the LEA's school board, the LEA shall respond to the CDE's subsequent requests for information no later than July 31, 2022.

Key Considerations

Transitional Kindergarten Implementation Timeline

As a condition of receipt of apportionment, school districts and charter schools must implement universally available TK for all four-year-old children by 2025–26 (EC 48000[c][1]). LEAs are encouraged to consider how this implementation timeline will impact elements of their UPK Plan, including whether implementing UTK on a fast timeline will allow the LEA to reach economies of scale with regard to the number of classrooms and TK teachers needed. The table below illustrates the UTK implementation timeline, including eligibility and ratios.

Table: TK Eligibility, Ratio, and Class Size Requirements by Fiscal Year

Type of Requirement	2021–22	2022–23	2023–24	2024–25	2025–26
Eligibility	Turn five between September 2 and December 2; at district discretion,	Turn five between September 2 and February 2; at district discretion,	Turn five between September 2 and April 2; at district discretion, turn	Turn five between September 2 and June 2; at district discretion, turn	Turn four by September 1

Type of Requirement	2021–22	2022–23	2023–24	2024–25	2025–26
	turn five between December 3 and the end of the school year	turn five between February 3 and the end of the school year	five between April 3 and the end of the school year	five between June 3 and the end of the school year	
Ratios	Not specified	1:12	1:10**	1:10**	1:10**
Class Size	24	24	24	24	24

* average class size across the school site

** Subject to future legislative appropriation

Supporting a Preschool through Third Grade Continuum

The CDE recently launched a Preschool through Third Grade (P–3) Alignment Initiative rooted in research that suggests the gaps in children’s opportunities and learning outcomes demand system-level reform at the state, county, district, school, and community level. Through this work, the CDE hopes to disrupt inequities, address bias, and promote equitable opportunities for California’s early learners. UPK implementation presents a critical opportunity to strengthen P–3 alignment, as a means of sustaining and accelerating the improved child outcomes associated with high-quality, early learning experiences.

To ensure the LEA’s plan is aligned with the vision of a P–3 continuum, the development team for the LEA UPK Plan (for which this document is a template) should include staff from the early education department (if there is one), curriculum and instruction, student programs, workforce, HR, business services, special education, multilingual education, expanded learning and afterschool, and facilities. Furthermore, to create a strong UPK system that meets families’ needs, the voices and choices of parents should be centered. Furthermore, LEAs should conduct outreach to the early learning and care providers that operate within the zip codes that the LEA serves to include them in informing the development of the LEA’s UPK Plan.

As a best practice, the CDE recommends LEAs convene a public engagement process to gather input and perspectives to inform the plan by March 1, 2022. This engagement process should include parents, early education communities (including CSPP and Head Start), expanded learning communities (including the ASES Program), and early learning and care (including center- and home-based child care) in order to gather information from impacted communities to inform the development of this plan.

Full-Day, Extended Learning and Care

State law does not require LEAs to operate a TK program that offers full-day early learning to all children the year before kindergarten; however LEAs must articulate how they plan to offer full-day, early learning programming to all students, and how they are partnering or plan to partner with other programs, such as those listed in the statute, to ensure that every child has access to extended learning and care that, combined, equates to a full-day of programming that meets the community’s needs.

Additionally, starting in the 2022–23 school year, LEAs receiving ELO-P funding must offer nine hours of combined instructional time and expanded learning opportunities per instructional day to all unduplicated children enrolled in TK and at least 30 intersession days; however, LEAs are not required to exclusively use ELO-P funding to meet the requirement. LEAs can instead partner with Head Start, CSPP, ASES, or other community-based child care programs to fund and provide the additional extended learning and care hours needed to reach nine hours. (EC Section 46120). This would allow the LEA to use ELO-P funds to provide additional service hours or services for additional children.

Creating Joint or Aligned Plans

LEAs are permitted to partner in creating a joint UPK Plan and may submit the same plan for multiple LEAs. Small and rural LEAs serving similar communities, especially those with low TK or kindergarten average daily attendance (ADA), are strongly encouraged to consider creating a joint UPK Plan which includes non-district learning programs serving four-year-old children. LEAs are also encouraged to consider partnering with other nearby LEAs to submit a joint UPK Plan or with their COE to create a single, countywide plan. These joint plans should be developed in conjunction with CSPP, Head Start, other preschool programs, and early learning and care providers.

**UPK Planning Template
Self-Certification**

In the data collection survey submitted to the CDE, LEAs must self-certify they developed a plan that was presented for consideration by the governing board or body at a public meeting on or before June 30, 2022, for how all children in the attendance area of the LEA will have access to full-day learning programs the year before kindergarten that meet the needs of parents, including through partnerships with the LEA's expanding learning offerings, ASES, CSPP, Head Start programs, and other community-based early learning and care programs.

1. Please complete the following table:

LEA Name	Contact Name and Title of the Individual Self-Certifying the Statement Above	Email	Phone
Rio Elementary School District			

2. Did the LEA develop a joint plan with multiple LEAs (for example, multiple small and rural LEAs serving similar communities or countywide plans developed with support of the COE for all LEAs in the county)? [select one]

No

3. If the LEA answered Yes to Question 2, what other LEAs are part of this joint plan?

Projected Enrollment and Needs Assessment Recommended Planning Questions

The CDE recommends LEAs prioritize these questions as part of their UPK Plan in addition to required questions.

1. What do existing data sources indicate about parental needs and preferences related to early learning and care programs for three- and four-year-old children in the LEAs attendance area? (LEAs are encouraged to work with local early learning and care partners such as CSPP, Head Start programs, LPCs, R&Rs, and APPs, and utilize data sources such as LPC Needs Assessment data, Head Start Needs Assessments, and so on)
2. Using the projected TK enrollment for the LEA provided by the CDE, make modifications to the LEA's TK student estimates and make cumulative facilities and staffing estimates needed each year from school year 2022-23 to 2025-26. Complete the following tables.

Table: Projected Student Enrollment

Type of Student	2019-20	Current (TK-eligible children turn five between September 2 and December 2, inclusive)	2022-23 (TK-eligible children turn five between September 2 and February 2, inclusive)	2023-24 (TK-eligible children turn five between September 2 and April 2, inclusive)	2024-25 (TK-eligible children turn five between September 2 and June 2, inclusive)	2025-26 (TK-eligible children turn four by September 1)
TK Students	81	73	148	151	166	207
CSPP (if applicable)			230	230	230	230

Table: Facilities Estimates (Cumulative)

Type of Facility	2019-20	Current	2022-23	2023-24	2024-25	2025-26
TK Classrooms						
CSPP Classrooms	5	6	6	6	6	6
Head Start or Other Early Learning and Care Classrooms	5	5	5	5	5	5

Table: Staffing Estimates (Cumulative)

Type of Staff	2019-20	Current	2022-23	2023-24	2024-25	2025-26
TK Teacher's Assistants	0	0	7	7	7	9
CSPP (if applicable)						

Type of Staff	2019-20	Current	2022-23	2023-24	2024-25	2025-26
Other CSPP Classroom Staff (if applicable)						
Early Education District-level staffing (if applicable)						

3. As part of the ELO-P requirements, EC Section 8281.5 requires LEAs to offer or partner in offering in-person before school or after-school expanded learning opportunities that, when added to daily instructional minutes, are no fewer than nine hours of combined instructional time and expanded learning opportunities per instructional day, including through partnerships with the LEA's expanding learning offerings, ASES, CSPP, Head Start programs, and other community-based early learning and care programs.

Consider your estimated number of TK students. Estimate the number of TK students that will utilize extended learning and care services in addition to the TK instructional minutes. Then, working with local early learning and care and expanded learning partners, estimate the number of slots available for TK students in the following programs:

Table: Projected Number of TK Students Utilizing Extended Learning and Care

2019-20	Current	2022-23	2023-24	2024-25	2025-26
0	0				

Table: Projected Number of Slots Available for TK Students

Slot Type	2019-20	Current	2022-23	2023-24	2024-25	2025-26
Head Start						
ASES Program/ELO-P	0	20	148	151	166	230

Required Questions

CDE will be requiring this information be completed after the plan is presented to the governing board.
 There are no required questions in this section.

Focus Area A: Vision and Coherence

In order to provide equity of access for all students and their families, it is vital for the LEA, in partnership with early learning and care programs, to develop a coherent educational system that begins with UPK, includes access to TK and other options for all four-year-old children, and provides nine hours of programming per day through a combination of instructional time and extended learning and care opportunities for those families who choose this option.

In planning for UPK, consider how the LEA's administrative structure will support school leadership in building connections between them and expanded learning programs as well as early learning and care programs (CSPP, Head Start, other subsidized or privately administered preschool and child care programs) to provide UPK programming and before school and after-school, intersession, and summer learning and care.

Recommended Planning Questions

The CDE recommends LEAs prioritize these questions as part of their UPK Plan in addition to required questions.

1. What is the LEA's vision for UPK?

UPK students in the Rio School District (RSD) will have access to quality, play-based, and developmentally appropriate academic and social emotional learning in an inclusive and culturally- and linguistically- responsive environment.

As of 2021-2022, the Rio School District offered TK or TK/Kindergarten programs at four sites. Outside agency preschool services are available at six sites. With that, all but one elementary school site, Rio del Sol, offer early learning programs to local children and families. The district also provided preschool programs to 48 children enrolled in RSD Special Education SDC preschool classes. Additionally, the Rio School District maintains an agreement with First 5 Ventura County to provide programming to local children 0-3 and their families at the Office of Student and Family Services. For the past several years, RSD has offered the Summer Jump Start program to all children who did not attend preschool. The program provides opportunities for social interaction with same-age peers, literacy foundational skills, and learning school routines. The program is available both in English only and as a Dual Language Immersion learning environment.

The Rio School District remains committed to providing quality early learning opportunities for all young learners.

2. In addition to TK, what service delivery models will be integrated to offer UPK programming, including the nine hours of total extended learning and care programming around the TK instructional time for families that opt in? In developing this component of the plan, LEAs should include partners such as CSPP, Head Start, and other early learning and care providers to ensure local services and funding are maximized and coordinated in response to parental needs and choice.

The Rio School District will offer expanded learning opportunities, equaling a nine-hour day, to children enrolled in TK through a combination of CSPP and ELOP funds and through partnerships with outside service providers. Providers who receive CSPP funding will enroll eligible TK students in their preschool/expanded learning programs onsite. Children who are English Language Learners, foster youth, or qualify for Free or Reduced Price Meals or McKinney Vento and are not eligible for CSPP will have the opportunity to participate in expanded learning through the district's ELOP funds. The Rio School District will contract with the CSPP providers to pay the expanded learning fees for those TK students not eligible for CSPP.

3. Describe the planned administrative structure that will support and monitor the UPK program and facilitate connections with the ELO-P as well as non-LEA-administered early learning and care programs that will support the extended learning components of UPK.

District administration will continue to communicate regularly with the agencies that administer the early learning programs on the Rio School District campuses through the Director of District Programs, who provides

guidance to the district's expanded learning programs as well as liaises with the outside preschool agencies. The Rio School District will hire a teacher from each site where the TK expanded learning programs are offered to support and communicate with all expanded learning program staff. Non-LEA administered preschool programs that will administer the expanded learning components of UPK are located on Rio School District campuses. The proximity of the programs to the regular day instructional program building may allow for increased collaboration with and monitoring of early learning and expanded learning programs.

4. Identify and assign each individual that will be responsible for key functions pertaining to implementing UPK (for example, academic or educational services, early childhood, facilities, human resources and labor, special education, English learner or multilingual programs, partnerships, including early learning and care and ELO-P, assessment and data collection, professional learning, workforce recruitment and preparation support, or others).

TK Curriculum Selection and Implementation- Curriculum Council, TK teachers, Assistant Superintendent of Educational Services

Assessments- Curriculum Council, TK and preschool teachers, preschool psychologist, Assistant Superintendent of Educational Services

ELO-P and Expanded Learning- Director of District Programs, early learning partners

Workforce recruitment- Human Resources department

Professional learning- PS/TK teacher network, Director of District Programs, Assistant Superintendent of Educational Services

Facilities requirements- Director of Facilities

5. Identify how UPK leadership will be integrated in the decision-making process at the executive or cabinet level.
Director of District Programs reports program updates to Assistant Superintendent of Educational Services, who presents reports and data to the executive cabinet.

6. Describe how the LEA's proposed UPK model will be integrated with the district's LCAP.

UPK model will be presented within the framework of the district's LCAP goals at community meetings, such as PAC and PELAC, where LCAP is being discussed. The district will elicit community feedback and questions. The following are the district's LCAP goals:

1. Broad Goal: Provide world class educational opportunities that support positive and healthy "Pupil Outcomes" for all students.
2. Maintenance Goal: Provide thriving "Conditions for Learning" that will provide all students with the 5C's; collaboration, communication, critical thinking, caring and creativity.
3. Focus Goal: Maintain and strengthen learning environments that fully "Engage" and provide enriching opportunities that support academic standards

The district is in the process of identifying and defining needs for UPK based on educational partner input. The district has begun collaborating with expanded learning partners to solidify plans for providing an nine-hour day option for TK students.

7. Describe how the LEA plans to ensure the inclusion of students with disabilities in UPK classrooms and who will be involved in the process.

UPK planning team will include Special Education preschool administrators, teachers, and psychologist, who will meet to share data and research-supported practices for inclusion of children preschool and transitional kindergarten age. On campuses where both Special Education and Transitional Kindergarten classes are housed, there will be increased opportunities for interaction between similar-age groups. The district's Curriculum Council will include Special Education preschool and Transitional Kindergarten teachers, which will allow opportunities to discuss opportunities and best practices for inclusion. The district will continue to explore models, such as co-teaching, in the future. Rio School District participates in the Inclusive Early Education and

Expansion Program (IEEEP) and plans to utilize the adaptive equipment and materials funds to purchase items to accommodate children with disabilities in having access to education in the least restrictive environment.

8. Describe how the LEA plans to support sites in building connections between them and ELO-P, as well as early learning and care partners.

Every site has an assigned after school program coordinator who oversees the daily operations of expanded learning programs on campus. The Rio School District will also hire a teacher from each site where the TK expanded learning programs are offered to support and communicate with expanded learning program staff. Contracted expanded learning service providers for UPK students will work in collaboration with the after school program coordinator and after school program teacher liaison. RSD maintains strong, long-standing relationships with early learning partners who provide California State Preschool Programs (CSPP), Head Start, and parent and child classes. We also have existing partnerships with expanded learning providers and will leverage both of these types of relationships and encourage collaboration to provide quality, developmentally appropriate expanded learning programs on RSD campuses.

Required Questions

CDE will be requiring this information be completed after the plan is presented to the governing board.

1. Which of the following model(s) of service delivery does the LEA plan to implement for UPK for all four-year-old children, including classes fully inclusive of children with disabilities, to provide access to the least restrictive environment for learning? [select all that apply]

TK offered at some sites

TK stand-alone classes

TK and kindergarten combination classes

CSPP stand-alone classes

Head Start stand-alone classes

2. Does the LEA plan to implement full-day TK, part-day TK, or both? [select one]

Full Day TK

3. Describe how the model(s) of service delivery selected in the preceding two questions will be implemented across the LEA's sites and why.

Availability of transitional kindergarten programs at various campuses will depend on enrollment and availability of facilities that meet required kindergarten classroom standards. The Rio School District has an existing full-day TK and will continue to offer this schedule.

4. Does the LEA plan to begin operating a CSPP or expand its current CSPP contract? [select one]

No - the LEA has no plans to begin or expand a CSPP contract in future years

5. If the LEA answered yes in question four, what age of children does the LEA plan to serve through a CSPP contract? [select all that apply]

6. Please indicate if the LEA plans to serve students eligible for early admittance TK, for children whose fifth birthday occurs after the enrollment date for the year of implementation (see implementation timeline above)?

a. 2022–23 (Birthdays February 3 or after) [select one]

Yes

b. 2023–24 (Birthdays April 3 or after) [select one]

Yes

c. 2024–25 (Birthdays June 3 or after) [select one]

Yes

Focus Area B: Community Engagement and Partnerships

To successfully implement UPK and create a P–3 continuum, LEAs will need to cultivate relationships and collaborate with both internal and external partners.

Recommended Planning Questions

The CDE recommends LEAs prioritize these questions as part of their UPK Plan in addition to required questions.

1. How does the LEA's UPK Plan prioritize parental needs and choices?

The Rio School District's UPK Plan prioritizes parental choice of language delivery by offering a dual language immersion TK program and by offering after school early learning programs to transitional kindergarten students through the use of district ELOP and outside service provider CSPP funds to those families who opt for extended day care. Depending on spaces available, RSD will make TK available to those children turning five after February 2, 2023. To support parent choice, RSD will continue to make families aware of CSPP and Head Start program availability on RSD campuses. RSD will continue outreach to families of 4 year olds in collaboration with partner early childhood education providers.

2. How does the LEA plan to meaningfully engage extended learning and care partners in the development of the LEA's UPK Plan?

The Rio School District has engaged in UPK/ELOP planning with current partners, Catalyst Kids, Child Development Resources, Boys and Girls Club of Greater Oxnard and Port Hueneme, and YMCA. The Rio School District plans to utilize a combination of funding, including CSPP and ELOP, in order to offer expanded learning to TK children starting in the spring of the 21-22 school year. The expanded learning plan for TK students provides parent choice and takes into account parent needs.

3. What actions does the LEA plan to take to partner with local R&Rs; LPCs; and existing early education, child care, and expanded learning providers within the LEA's attendance boundary to support parents to access services across LEA-administered and non-LEA-administered programs for extended learning and care and other supports?

The Rio District has developed plans with current early learning providers on district campuses to create an expanded day program for TK students on the same campuses where students attend during the regular day. The proximity of these programs will reduce the need for student transportation provided by families to an outside after school care location. District administrators continue to meet with community partners who are our local Resource and Referral agency to build connections with resources available to families in the Rio School District. The Rio School District maintains an agreement with First 5 Ventura County to operate their Neighborhood for Learning on district property to provide access to early learning to local families with children 0-3. These services include Parent and Child classes and ASQ assessments.

4. How does the LEA plan to create or grow partnerships with early learning and care providers serving children with disabilities (including how the LEA plans to collaborate with their SELPA to enroll more children with disabilities in inclusive UPK opportunities)?

In the 2021-2022 school year, the Rio School District enrolled 48 preschool students in the district special education preschool and an additional 33 preschool age students who received special education services. Some of these children will be eligible for transitional kindergarten in 2022-2023. The Educational Services department in the Rio School District houses the Pupil Personnel Services department. As such, leadership from these departments continue regarding best practices for inclusion, the impact of TK expansion on Special Education preschool enrollment, and developmental assessments. Special Education preschool teachers, psychologist, and administrators have contributed to the UPK planning team from the formation of the networking group. Starting in 2022-2023, the Special Education preschool teachers will be included in the district's curriculum council and be provided opportunities to collaborate with general education TK teachers. RSD will continue collaboration with

non-LEA early education partners through IEEP to support students with disabilities in early learning settings on RSD campuses.

5. Develop sample program schedules that describe how the requirements of the ELO-P will be met for UPK, including the use of ELO-P funds or other fund sources; how they will be combined with the instructional day to offer a minimum of nine hours per day of programming (instructional day plus ELO-P or other supports); and how they will offer a minimum nine-hour summer or intersession day.

Sample TK/Kinder ELO-P Schedule

12:40 - 12:45	TK/Kinder Pick Up
12:45 - 12:55	Wash Hands
12:55 - 1:15	Snack
1:15 - 2:00	Homework
2:00 – 2:15	Class Announcements
2:15 - 3:15	30 Fit
3:15 3:20	Wash Hands
3:20 – 4:20	Clubs
4:20 – 6:00	Open Recreation

Required Questions

CDE will be requiring this information be completed and submitted to the CDE after the plan is presented to the governing board.

1. Identify which of the following opportunities the LEA implemented to obtain public input on the UPK Plan. [Select all that apply]

Family or parent surveys

Special Education Local Plan Area (SELPA)

Co-hosting events with community-based organizations (CBOs)

Hosting meet and greets with the early learning and care community

2. Select which programs the LEA plans to combine with the TK instructional day to offer a minimum of nine hours per day of programming (instructional day plus programming) for children whose families opt in for extended learning and care. [select all that apply]

Expanded learning programs on an LEA site (ASES, 21st Century Community Learning Centers [21st CCLC], ELO-P)

CSPP (on an LEA site)

Focus Area C: Workforce Recruitment and Professional Learning

Based on the projected enrollment and needs described in Focus Area A, LEAs should create a plan to recruit, train, and support the new TK, preschool, early learning and care, and expanded learning staff needed to support full-day early education options for all children the year before kindergarten.

(Note: All LEAs will need to plan for workforce development considerations as part of this planning work. There is a separate \$100 million allocation for the Prekindergarten Planning and Implementation Grant – Competitive, also known as the Early Education Teacher Development Grant, that will be competitively awarded and is not part of this planning template.)

EC Section 48000(g)(4) specifies that credentialed teachers who are first assigned to a TK classroom after July 1, 2015, have, by August 1, 2023, one of the following:

- a. At least 24 units in early childhood education, or childhood development, or both.
- b. As determined by the LEA employing the teacher, professional experience in a classroom setting with preschool age children that is comparable to the 24 units of education described in subparagraph (a).
- c. A Child Development Teacher Permit issued by the CTC.

EC Section 8295 specifies that teachers in CSPP shall either possess a permit issued by the CTC authorizing service in the care, development, and instruction of children in a child care and development program; or meet the following criteria:

- a. Possess a current credential issued by the CTC authorizing teaching service in elementary school or a single subject credential in home economics; and
- b. Possess twelve units in early childhood education or child development, or both, or two years' experience in early childhood education or a child care and development program.

Recommended Planning Questions

The CDE recommends LEAs prioritize these questions as part of their UPK Plan in addition to required questions.

1. How does the LEA plan to recruit the educators needed to implement its UPK Plan (including CSPP teachers, assistant teachers, TK teachers, and TK teachers' instructional aides and assistants)?

The Rio School District Human Resources department has collected data on the numbers of teachers currently employed who may meet the requirements for teaching TK. In partnership with CSU Channel Islands, RSD participates in the teacher residency program which will begin recruiting candidates for 22-23. Additionally, RSD will join the Ventura County Early Education Teacher Development Consortium to support retention of existing staff who are interested in obtaining qualifications for TK and for new staff interested in teaching TK.

3. What is the LEA's planned strategy for providing professional learning for educators across the LEA's P-3 continuum? Plans might include the following:
 - a. Who will receive this professional learning?
 - i. By role (lead teachers, assistant teachers, administrators, coaches, and so forth)
 - ii. By grade (TK staff, kindergarten through third grade staff, on-site preschool staff, off-site preschool staff, and so forth)
 - b. What content will professional learning opportunities cover?
 - i. Effective adult-child interactions
 - ii. Children's literacy and language development (aligned with the California Preschool Learning Foundations and the California Preschool Curriculum Frameworks)
 - iii. Children's developing math and science (aligned with the California Preschool Learning Foundations and the California Preschool Curriculum Frameworks)

- iv. Children’s social-emotional development (aligned with the California Preschool Learning Foundations and the California Preschool Curriculum Frameworks)
- v. Implicit bias and culturally- and linguistically-responsive practice
- vi. Adverse Childhood Experiences (ACEs) and trauma- and healing-informed practice
- vii. Curriculum selection and implementation
- viii. Creating developmentally-informed environments
- ix. Administration and use of child assessments to inform instruction
- x. Support for multilingual learners, including home language development and strategies for a bilingual classroom
- xi. Serving children with disabilities in inclusive settings, including Universal Design for Learning
- xii. Engaging culturally- and linguistically-diverse families
- c. How will professional learning be delivered?
 - i. Coaching and mentoring
 - ii. Classroom observations and demonstration lessons with colleagues
 - iii. Workshops with external professional development providers
 - iv. Internally-delivered professional learning workshops and trainings
 - v. Operating an induction program
 - vi. Partnerships with local QCC professional learning in CSPP settings
 - vii. In mixed groupings (for example, TK and CSPP teachers)

RSD, in collaboration with TK and preschool teachers, has planned several hours of collaboration time and professional development for TK teachers and preschool teachers.

4. How does the LEA plan to facilitate the development of a district early education leadership team (across grade levels and departments) and promote site-based horizontal and vertical articulation (P–3) teams to support student transitions, share strategies, and collaboratively monitor student progress?

The Rio School District will include Special Education Preschool and Transitional Kindergarten teachers in the existing Curriculum Council. Preschool and TK teachers will have opportunities to meet for vertical alignment as well as lateral collaboration. Also, CSPP and Head Start providers on RSD campuses join professional learning offerings through IEEEP and QCVC and will continue to do so once available via the EETD grant and UPK county-wide trainings.

Required Questions

CDE will be requiring this information be completed after the plan is presented to the governing board.

1. Which of the following strategies does the LEA intend to use to support diverse and effective prospective TK teachers, including multilingual educators, to earn a Multiple Subject Teaching Credential? [select all that apply]

Partner with a COE to provide other services to candidates seeking to earn a multiple subject credential

2. Which of the following strategies does the LEA intend to employ to support diverse and effective prospective TK teachers, including multilingual educators, to meet the requirements under EC Section 48000(g)(4)? [select all that apply]

Apply for workforce development funding and grant opportunities

Provide information on scholarship and grant opportunities

Other [describe, open response]

Continue to participate in the Teacher Residency program partnership with CSUCI

3. Which of the following strategies does the LEA intend to employ to support diverse and effective prospective CSPP teachers, including multilingual educators, to obtain a Child Development Teacher Permit [select all that apply]

Provide advising on requirements and planning for how to meet the Child Development Teacher Permit requirements

Apply for workforce development funding and grant opportunities

4. On which child observational assessments does the LEA intend to offer professional learning to TK, CSPP, and other early education teachers during the 2022–23 school year? [select all that apply]

LEA-based, grade level benchmarks and a report card

Ages & Stages Questionnaire (ASQ)

Desired Results Developmental Profile (DRDP)

5. On what topics does the LEA intend to offer professional learning regarding early childhood education to site leaders and principals? [select all that apply]

ACEs and trauma- and healing-informed practice

Curriculum selection and implementation

Administration and use of child assessments to inform instruction

Support for multilingual learners, including home language development and strategies for a bilingual classroom

Serving children with disabilities in inclusive settings, including Universal Design for Learning

Children's literacy and language development (aligned with the Preschool Learning Foundations and Frameworks)

Children's developing math and science (aligned with the California Preschool Learning Foundations and the California Preschool Curriculum Frameworks)

Children's social-emotional development (aligned with the California Preschool Learning Foundations and the California Preschool Curriculum Frameworks)

Implicit bias and culturally- and linguistically-responsive practice

Focus Area D: Curriculum, Instruction, and Assessment

It is critical for each LEA and preschool program partner to plan for how they will develop or select curriculum or curricula that are developmentally-informed and aligned with the strengths of all students, including multilingual students and students with disabilities, as well as how they will ensure curricula are implemented with fidelity to support intentional, quality instruction for all students. LEAs and preschool program partners should consider how they will provide coherent, culturally- and linguistically-responsive UPK curriculum or curricula anchored in the California Preschool Learning Foundations (<https://www.cde.ca.gov/sp/cd/re/psfoundations.asp>) and the California Preschool Curriculum Frameworks (<https://www.cde.ca.gov/sp/cd/re/psframework.asp>) to support the development of skills across the domains outlined in those documents.

Recommended Planning Questions

The CDE recommends LEAs prioritize these questions as part of their UPK Plan in addition to required questions.

1. Describe how the LEA will develop or select a curriculum for UPK classrooms that aligns with the California Preschool Learning Foundations and California Preschool Curriculum Frameworks.

TK, kindergarten, and preschool teachers have collaborated with district administrators to review, select, and pilot curricula for TK.

2. Describe the intended timeline for curriculum implementation, including steps for piloting and gathering input from UPK teachers, and a process for ensuring curriculum fidelity.

Since January 2022, Rio School District UPK teachers have met monthly to discuss curriculum and assessments for the district's UPK plan. UPK teachers will review and pilot materials in Spring 2022 and share feedback with the district's Curriculum Council. Starting in fall, 2022, the district's Curriculum Council will invite and include UPK teachers, including preschool special education teachers and transitional kindergarten teachers, to participate in regular, districtwide meetings. The district and RTA are in discussions about providing collaboration time starting in the Fall of 2022 for TK and Special Education Preschool teachers. The district will follow collective bargaining agreements with Rio Teachers' Association for curriculum review and implementation.

3. What actions does the LEA plan to take to support effective classroom organization practices and behavior management strategies to ensure a positive learning environment for a diverse population of UPK students?

The Rio School District will provide UPK teachers and instructional assistants with professional learning opportunities in the areas of social emotional learning and Positive Behavioral Interventions and Supports (PBIS). The TK/PS curriculum subcommittee will review and select developmentally appropriate SEL materials by the end of the 2022-2023 school year. RSD participates in the IEEEP, SIP professional development, CA Teaching Pyramid trainings, all of which are approaches to support and to prevent challenging behaviors. Professional development provided by the SELPA and VCOE-ECP is accessed by RSD staff.

4. Describe how classroom practices for UPK (TK and other preschool programs the LEA operates or has on site) will be integrated and aligned.

TK and Special Education Preschool will be included in district Curriculum Council. TK and Preschool teachers will have opportunities to meet together for vertical articulation as well as in grade-level specific collaborative meetings. TK and Preschool teachers will also have opportunities for combined professional learning in the area of early learning. The preschool program operated by outside service providers on Rio School District Dual Language Immersion campuses will provide language development continuity by providing instruction in the target language.

Required Questions

CDE will be requiring this information be completed after the plan is presented to the governing board.

1. Does the LEA plan to provide any of the following language model(s) for TK students? [select all that apply]

English-only instruction with home-language support

Dual language program with a language allotment of 90/10 [open response for language offered]

2. If the LEA administers CSPP, does it plan to provide any of the following language model(s) for CSPP students? [select all that apply]

LEA does not administer CSPP

3. Identify methods the LEA plans to use to support the development of social-emotional learning and executive function skills through specific instruction in these areas and by embedding and reinforcing this instruction in all curriculum areas. [select all that apply]

Promote learning through play as a context for social and emotional development, including social play with teachers and peers in small or large group settings

Designing developmentally-appropriate learning environments to allow for individual and group activities that promote social-emotional learning and executive function skills (for example, use students' pictures or words in daily routines, feelings charts)

Staff development opportunities encouraging reflective practice and cross-level support for instruction specific to social-emotional learning and executive function skills

Implement the CSEFEL Pyramid Model in the classroom

4. What instructional practices does the LEA plan to implement to support children with disabilities in UPK programming? [select all that apply]

Implement social-emotional strategies, such as the Pyramid Model, CSEFEL, and others

Provide specialized services (for example, occupational therapy, physiotherapy, speech and language pathology therapy) in the classroom with peer models

Implement social-emotional strategies, such as the Pyramid Model, CSEFEL, and others

Provide additional staff to support participation in instruction

Implement Universal Design for Learning

5. What assessments does the LEA plan to use in TK or kindergarten? [select all that apply]

LEA-based grade level benchmarks and a report card

Focus Area E: LEA Facilities, Services, and Operations

It is critical to ensure that LEA facilities, services, and operations are thoughtfully aligned to support the implementation of UPK and movement towards a P–3 continuum. It is also critical for early education programs currently operating to continue to be a part of California’s mixed-delivery system by creating shared space, blending funding and coordinating service delivery.

For Facilities:

For facilities planning, draw on the Projected Enrollment and Needs Assessment section of this document and the LEA’s Facilities Master Plan. The objectives of this section are to identify the availability of space for UPK, the adequacy of available space to meet the kindergarten facilities standards for meeting the needs of young children, and, if needed, to update the Facilities Master Plan to address any unmet need for developmentally-appropriate space.

Recommended Planning Questions

The CDE recommends LEAs prioritize these questions as part of their UPK Plan in addition to required questions.

1. What strategies does the LEA plan to employ to integrate younger children and older children on the same campus and ensure safety and appropriate commingling?

As of 2022, there are early education- TK or preschool programs- on all elementary campuses with the exception of Rio del Sol. These early education programs are either transitional kindergarten classrooms, district administered special education preschool programs, or non-LEA administered CSPP or Head Start preschool programs. The Rio School District has longstanding partnerships with outside agencies who provide early education on TK-5 and TK-8 district campuses. Additionally, the district's Special Education preschool program has operated at many of the district's elementary campuses. The district will analyze spaces on all elementary campuses to determine capacity and adequate facilities for younger children.

2. Describe how the LEA plans to address transportation issues resulting from UPK implementation.

The Rio School District will analyze the needs of parents and availability of transportation resources.

Required Questions

CDE will be requiring this information be completed after the plan is presented to the governing board.

1. To support an overall increase in UPK access, what efforts does the LEA plan to make to prevent the displacement of any early education programs on LEA campuses, including both LEA-administered and non-LEA-administered programs?

The Rio School District continues partnerships with outside early education programs on district campuses. The district continues to collaborate with these partners to develop specific plans for these early educators to provide after school care through ELO-P funds to district TK and kindergarten students.

2. Does the LEA have adequate classroom space to meet the Projected Enrollment of TK students listed in the Projected Enrollment and Needs Assessment section of this document, for the respective implementation year? [multiple choice]

Yes

- i. If no, how many more classrooms does the LEA need? [identify number, open response]

ii. If no, how might the LEA provide classrooms in the timeframe needed? [describe, open response]

3. Does the space meet the kindergarten standards described in California Code of Regulations, Title 5, Section 14030(h)(2)? [multiple choice]

No

i. If no, what modifications need to be made? What resources are needed to make them? (See Facilities Grant Program Funding at <https://www.dgs.ca.gov/OPSC/Services/Page-Content/Office-of-Public-School-Construction-Services-List-Folder/Access-Full-Day-Kindergarten-Facilities-Grant-Program-Funding>) [describe, open response]

While the current classroom spaces on Rio School District campuses currently exceeds the current enrollment, the number of spaces meeting kindergarten standards will not meet the need for future projected kindergarten and transitional kindergarten enrollments. The district will analyze spaces for proximity to ingress and egress, proximity of kindergarten classrooms to restrooms, square footage of each designated kindergarten classroom. The Rio School District will continue to analyze numbers of available spaces, number of spaces that meet the kindergarten standards, and projected TK and kindergarten enrollments. The Rio School District is not eligible at this time to apply for the Full Day Kindergarten Facilities Grant Program because current enrollment does not exceed the spaces available. The District will continue to explore funding options to make modifications where necessary. RSD participated in the IEEEEP and plans to utilize the adaptive equipment and materials funds to purchase items to accommodate children with disabilities in having access to education in the least restrictive environment.

4. Does the space contain necessary adaptive equipment, assistive technology, or other accommodations to ensure children with disabilities have access to education in the least restrictive environment? [multiple choice]

No

i. If no, what modifications need to be made? What resources are needed to provide equipment or accommodations? [describe, open response]

In collaboration with Rio School District Special Education educators, district administration will make recommendations for modifications to purchase adaptive equipment necessary to ensure that children with disabilities have access to education in the least restrictive environment. The District will also research the resources and best practices for full-inclusion and co-taught classrooms in early education.

5. Does the LEA's Facilities Master Plan adequately address the need for UPK programming? [multiple choice]

No

i. If no, what process will the LEA use to update the Facilities Master Plan to accommodate future TK and early education programming? [describe, open response]

The Rio School District will continue to analyze spaces according to kindergarten facilities guidelines for new and retrofitted spaces as well as site administrator and teacher feedback. A Facilities Master Plan shall be updated to include future TK enrollment projections.

6. In which of the following areas does the LEA intend to make updates to facilities? [select all that apply]

None of the above

7. What transportation will the LEA offer to children enrolled in TK? [select all that apply]

Transportation to and from the TK program

8. Will the LEA offer transportation to transport TK children to extended learning and care opportunities that are at other sites than the one the child is enrolled at for TK?

No

Technical Assistance Questions

The CDE is collecting information on the type(s) and topics of technical assistance that LEAs need to support implementation of a robust UPK Plan and effective UPK program. This information will be used to leverage existing resources and inform future technical assistance opportunities provided by CDE partners, including COEs, to help ensure that the needs of LEAs are met.

The following questions are optional. However, unlike the recommended questions included in Focus Areas A through E, the CDE will be collecting any information that LEAs wish to provide in response to these questions via the survey that the CDE administers to collect the required data questions above.

1. What technical assistance would be most helpful related to projecting enrollment and assessing needs? [select all that apply]

Support for parent surveys to gauge interest in service delivery models

Data analysis capacity building to support staff to refine enrollment projections based on community context

2. What technical assistance would be most helpful related to the elements included in Focus Area A: Vision and Coherence? [select all that apply]

Adjusting classroom practices to support the district's UPK model (for example, mixed-age classrooms)

Creating inclusive classrooms, including implementing Universal Design for Learning

Technical assistance on how to integrate UPK and P-3 in the district LCAP

Considerations for TK early admittance

3. What technical assistance would be most helpful related to the elements included in Focus Area B: Community Engagement and Partnerships? [select all that apply]

Support for parent surveys and engagement activities to understand parent needs and support authentic choice

Guidance on best practices for enrolling more children with disabilities in UPK classrooms and providing services in inclusive settings

Increasing UPK enrollment and parent awareness of programs

4. What technical assistance would be most helpful related to the elements included in Focus Area C: Workforce Recruitment and Professional Learning? [select all that apply]

Additional guidance on UPK workforce requirements (TK, CSPP, and other early learning and care providers)

Creating joint professional learning opportunities for preschool and elementary school teachers within LEAs or across LEA- and CBO-administered programs

Strategies to support the teacher pipeline, including, but not limited to, recruiting multilingual educators, cohort models, apprenticeships, or residency programs

Building partnerships with IHEs or COEs to support professional learning opportunities and degree attainment

5. What technical assistance would be most helpful related to support for professional learning opportunities on specific topics? [select all that apply]

Children’s literacy and language development (aligned with the California Preschool Learning Foundations and the California Preschool Curriculum Frameworks)

Children’s math and science development (aligned with the California Preschool Learning Foundations and the California Preschool Curriculum Frameworks)

Children’s social-emotional development (aligned with the California Preschool Learning Foundations and the California Preschool Curriculum Frameworks)

Implicit bias and culturally- and linguistically-responsive practice

Trauma- and healing-informed practice

Creating developmentally-informed environments

Serving children with disabilities in inclusive settings, including Universal Design for Learning

6. What technical assistance would be most helpful related to support for specific professional learning delivery mechanisms? [select all that apply]

Coaching and mentoring

Classroom observations and demonstration lessons with colleagues

Workshops with external professional development providers

Internally-delivered professional learning workshops and trainings

Operating an induction program

7. What technical assistance would be most helpful related to the elements included in Focus Area D: Curriculum, Instruction, and Assessment [select all that apply]

Guidance on the selection, development, or integration of developmentally-informed curricula and aligning curricula across the early grades

Guidance on instructional practices to support children with disabilities in UPK (for example, implementing Universal Design for Learning, providing specialized services in the classroom with peer models, and implementing social-emotional strategies such as the Pyramid Model) and partnerships with early learning and care providers to support services for children with disabilities

Specific instructional strategies to support specific skills including, but not limited to, children’s social-emotional development and home language development

8. What technical assistance would be most helpful related to implementing hands-on, interactive, and developmentally-informed early education experiences for UPK students? [select all that apply]

Using differentiated groups that include individual, small, and large group experiences

Encouraging purposeful play, choice, social interactions, and collaboration

Creating time and space for children to develop gross motor skills inside the classroom and in the outdoor environment

Supporting students’ home language and English language development

Universal Design for Learning

Integrated English language development

9. What technical assistance would be most helpful related to the elements included in Focus Area E: LEA Facilities, Services, and Operations? [select all that apply]

Guidance on how to modify an elementary school classroom to serve young children

Appendix I - Definitions

The following definitions are critical for UPK planning efforts. Additional terms and definitions can be found in the Guidance Document:

- **Preschool through Third Grade (P–3):** P–3 is a continuum of learning from preschool through third grade that can be supported by intentional practices at the classroom, school, and leadership levels that align curricula, assessment, and professional learning opportunities to ensure instruction builds on the knowledge and skills that children acquire as they transition across grades and settings.
- **Universal prekindergarten (UPK):** UPK refers to universal TK as well as the expanded CSPP, Head Start, and early childhood special education services that families can choose from to create rich early learning opportunities for all three- and four-year-old children during the year or two years before kindergarten. In high-needs neighborhoods, the CDE strongly encourages LEAs to consider pairing TK programs with access to Head Start and CSPP for age- and income-eligible three- and four-year-old children to further bolster program quality, either through the LEA’s own Head Start or CSPP program or via a contract partnership with a CBO that administers a Head Start or CSPP.
- **Transitional kindergarten (TK):** TK means the first year of a two-year kindergarten program, serving four-year-old children regardless of income that uses a modified kindergarten curriculum that is age- and developmentally-appropriate (EC Section 48000 [d]).
- **Universal transitional kindergarten (UTK):** UTK refers to the expansion of TK by 2025–26 to serve all four-year-old children by September 1 of each year, regardless of income, providing a year of rich learning opportunities the year before kindergarten that families can choose from as part of California’s public education system.
- **California State Preschool Program (CSPP):** CSPP is the largest state-funded preschool program in the nation. CSPP includes both part-day and full-day services to eligible three- and four-year-old children. CSPP provides a core class curriculum that is developmentally, culturally, and linguistically appropriate for the children served. The program also provides meals and snacks to children, parent education, referrals to health and social services for families, and staff development opportunities to employees. The program is administered through LEAs, colleges, community-action agencies, local government entities, and private, nonprofit agencies.
- **Expanded learning:** This includes before school, after-school, summer, or intersession learning programs that focus on developing the academic, social, emotional, and physical needs and interests of pupils through hands-on, engaging learning experiences. It is the intent of the Legislature that expanded learning programs are pupil-centered, results-driven, include community partners, and complement, but do not replicate, learning activities in the regular school day and school year.
- **Expanded Learning Opportunities Program (ELO-P):** ELO-P provides funding for after-school and summer school enrichment programs for TK through sixth grade. The ELO-P is defined as services provided in addition to the normal school day and school year operations, to provide full-day and full-year expanded learning programs to meet the needs of working families whose children are enrolled in TK through sixth grade and also provide expanded learning enrichment programming for students. A full day is defined as in-person before school or after-school expanded learning opportunities that, when added to daily instructional minutes, are no fewer than nine hours of combined instructional time and expanded learning opportunities per instructional day. A full year includes a minimum of 30 days of programming in the summer and intersession for no fewer than nine hours of in-person expanded learning opportunities per day.
- **Early learning and care:** This refers to the continuum of programs serving children from birth to preschool or school entry, as well as extended care to support school-age children with before school and after-school care as well as vacation schedules. This includes general child care, Early Head Start and Head Start, community-based early learning and care programs, family child care providers, and family, friend, and neighbor care.
- **Extended learning and care:** This refers to the continuum of programs and services (early learning and care options and expanded learning options) available in addition to the normal school day and school year operations, to provide full-day and full-year care to meet the needs of working families whose children are enrolled in TK or kindergarten. A full day is defined as in-person before school or after-school programming or care that, when added to daily instructional minutes, provide no fewer than nine hours of combined instructional time and

expanded learning opportunities per instructional day. A full year includes a minimum of 30 days of programming in the summer and intersession for no fewer than nine hours of in-person expanded learning opportunities per day. Funding to support extended learning and care for children enrolled in TK includes the ELO-P and the CSPP, as specified in guidance provided by the CDE's Early Education Division. Additional subsidized care opportunities may be available to families who qualify, such as child care vouchers and the General Child Care School Age program.

Appendix II - Additional Deeper Planning Questions

This section includes optional planning questions for LEAs that are ready to develop more advanced UPK and P–3 plans.

These additional questions are designed to support the LEA’s development of a more comprehensive local UPK Plan. LEAs can also use these questions as a tool for integrating UPK into existing LEA plans such as the LCAP. LEA’s should assess their readiness to include any of these deeper planning questions in their initial planning process and reassess their readiness throughout the implementation of their UPK Plan.

Focus Area A: Vision and Coherence

1. If an LEA has a California State Preschool Plan (as part of the LEA’s application for its CSPP contract) what updates would the LEA like to make to the LEA’s program narrative to reflect implementation of TK?
2. Does the LEA plan to establish, maintain, and facilitate ongoing LEA leadership teams to focus on effective P–3 articulation and coordination throughout the LEA?
3. How will the LEA support sites in providing well-coordinated transitions for all P–3 students as they move through grade levels?
4. How does the LEA plan to communicate the importance of the P–3 continuum across a broad spectrum of audiences (including audiences internal and external to the district)?
5. Identify the processes and tools the LEA will use to strengthen understanding of early childhood development and facilitate communication between preschool and elementary school (including TK) teachers, principals, and administrators to support P–3 alignment?

Focus Area C: Workforce Recruitment and Professional Learning

1. What strategies does the LEA plan to employ to recruit multilingual educators to teach in dual language programs?
2. How does the LEA plan to assess the implementation of its professional learning structures to ensure efficacy?

Focus Area D: Curriculum, Instruction, and Assessment

8. Describe how the LEA plans to establish and maintain a coherent, culturally- and linguistically-responsive P–3 continuum to provide a strong integrated curriculum anchored in the California Preschool Learning Foundations and the California Preschool Curriculum Frameworks, California Common Core State Standards, and the Curriculum Frameworks.

9. What actions does the LEA plan to take to establish or expand multilingual programs across the P–3 continuum based on student population and family needs? (If the LEA has no plans to establish or expand multilingual programs across the P–3 continuum, identify how the LEA will evaluate these opportunities moving forward.)

10. What planning and actions are needed to accommodate a positive meal service, and how will the LEA adapt their universal meal program for TK students?

Focus Area E: LEA Facilities, Services, and Operations

4. Describe what changes the LEA intends to make to the LEA’s Facilities Master Plan to ensure it is consistent with P–3 goals of creating seamless transitions for children and families.

5. Identify how the LEA plans to ensure TK students are included in all provisions of Multi-Tiered Systems of Supports (MTSS) and, when necessary, special education instruction, with an emphasis on early intervention and inclusion practices to address supports and least restrictive environments.

6. Identify any modifications the LEA intends to make to the Student Information System (SIS) and the assessment data system to ensure teachers and administrators have access to data from preschool through third grade.

8.1



Agenda Item Details

Meeting	Jun 29, 2022 - RSD Regular Board Meeting
Category	8. Discussion/Action
Subject	8.1 Provisional Board Member Appointment
Access	Public
Type	Action
Recommended Action	Staff recommends that the Governing Board nominate and vote to appoint a Provisional Board Member to serve on the Governing Board until November of 2022.

Public Content

The Governing Board will begin the process of nominating a Provisional Board Member to serve on the Governing Board until November 2022.

Administrative Content

Executive Content

8.2



Agenda Item Details

Meeting	Jun 29, 2022 - RSD Regular Board Meeting
Category	8. Discussion/Action
Subject	8.2 Resolution No. 21/22-26 of the Board of Trustees of the Rio Elementary School District Ordering a School Bond Election, Establishing Specifications of the Election Order, and Requesting Consolidation with Other Elections Occurring on November 8, 2022.
Access	Public
Type	Action
Recommended Action	Staff recommends approval and adoption of Resolution No. 21/22-26 Ordering a School Bond Election, Establishing Specifications of the Election Order, and Requesting Consolidation with Other Elections Occurring on November 8, 2022.
Goals	<p>Goal 1-Improved student achievement at every school and every grade in all content areas</p> <p>Goal 2-Engage parents and other District stakeholders in the development of meaningful partnerships to support student learning.</p> <p>Goal 3-Create welcoming and safe environments where students attend and are connected to their school</p>

Public Content

Speaker:
Wael Saleh, Assistant Superintendent, Business Services

Rationale:

The Board of Trustees is being asked to review a proposed Resolution calling for a general obligation bond election to determine if 55%, or more, of the District's voters will approve the issuance of general obligation bonds. The election will be held on November 8, 2022, and will be consolidated with other elections to be held on the same date.

In 2018, the Board of Trustees called a general obligation bond election, known as Measure L, pursuant to its Resolution No. 1718/32, held on November 6, 2018. The Registrar of Voters of Ventura County (the "Registrar") canvassed the returns of the November 6, 2018 election, as required by law, and delivered to the Board a certificate of election results certifying that at least 55 percent of the votes cast on Measure L were in favor of issuing bonds.

Using the bond proceeds from Measure L, the District has successfully completed several projects. The District has exercised strong fiscal management with regards to the expenditure of Measure L bond proceeds. All Measure L bond expenditures to date have been reviewed by the District's independent citizens oversight committee comprised of community, business, taxpayer association, and parent representatives.

The District recently conducted a survey of potential voters, and the results indicated continued voter support for an additional bond authorization. In order to make additional necessary progress modernizing outdated school facilities, improving health, safety, and security, and improving the overall quality of education, the District has determined there is a need for additional bond authorization. This new bond authorization would extend, but not increase the current tax rates, allowing the District to continue to make needed capital improvements to District facilities with no projected increase in tax rates.

Additional bond authorization will also improve the District's chances of successfully accessing matching funds from the State's school facilities funding program.

Resolution Calling November 2022 Election (3) (1).pdf (296 KB)

Administrative Content

Executive Content

RESOLUTION NO. 21/22-26

**RESOLUTION OF THE BOARD OF TRUSTEES OF THE
RIO ELEMENTARY SCHOOL DISTRICT
ORDERING A SCHOOL BOND ELECTION,
ESTABLISHING SPECIFICATIONS OF THE ELECTION ORDER,
AND REQUESTING CONSOLIDATION WITH OTHER ELECTIONS
OCCURRING ON NOVEMBER 8, 2022**

WHEREAS, the Rio Elementary School District (the “District”) is an elementary school district, serving transitional kindergarten through 8th grade, duly organized under the laws of the State of California;

WHEREAS, the Board of Trustees of the District (the “Board”) is authorized, upon a two-thirds vote of the Board, to pursue the approval and issuance of bonds by a 55% vote of the electorate on the question of whether bonds of the District (the “Bonds”) shall be issued and sold for specified purposes, under Article XIII A Section 1 paragraph (b) of the California Constitution (“Article XIII A”) and under the Strict Accountability in Local School Construction Bonds Act of 2000 at Education Code Section 15264 et seq. (the “Strict Accountability Act”);

WHEREAS, under the Strict Accountability Act, a general obligation bond election may be ordered at a primary or general election, a regularly scheduled local election, or statewide special edition;

WHEREAS, under Section 10403 et seq. of the California Elections Code, it is appropriate for the Board to request consolidation of the election with any and all other elections to be held on Tuesday, November 8, 2022, and to request the Ventura County Registrar of Voters (the “County Registrar”) to perform certain election services for the District; and

WHEREAS, the Board deems it necessary and advisable to call a general obligation bond election to submit to the electors of the District the question of whether District bonds shall be issued and sold for the purpose of raising money for the acquisition and improvement of real property and the furnishing and equipping of school facilities of the District.

NOW, THEREFORE, the Board does hereby resolve, determine, and order as follows:

Section 1. Election Order; Ballot Measure. Pursuant to Education Code sections 5304, 5322 and 15264 *et seq.* and article XVI, section 18(b) of the California Constitution, an election shall be held within the boundaries of the District on November 8, 2022 submitting to the voters of the District the question of whether Bonds of the District, in the amount of \$72,000,00 shall be issued and sold for the purposes of improving the quality of education in local schools and protecting the safety of the students of the District. Specifically, Bond proceeds shall be utilized for the purposes of financing the acquisition, construction, renovation, furnishing, and equipping of school facilities, support facilities, equipment, and technology all as identified in the Full Text of the Ballot Measure (the “Full Text”) set forth in **Exhibit A** attached hereto and incorporated herein by reference, under the heading “School Facilities Projects to Be Funded with Proceeds of Bonds” (the “Financed Facilities”), and including costs incident thereto as set forth in the Full

Text. The Bonds proposed to be issued and sold shall bear interest at a rate not exceeding the statutory limit, and the number of years any Bonds are to run shall not exceed twenty-five (25) years from the date of the Bonds or the date of any series thereof in the event the Bonds are issued pursuant to Education Code section 15144, and shall not exceed forty (40) years from the date of the Bonds or the date of any series thereof in the event the Bonds are issued pursuant to Government Code section 54400. This Resolution constitutes the order of the District to call such election and shall constitute the “specifications of the election order” pursuant to Education Code Section 5322.

Section 2. Use of Bond Proceeds; Facilities Specifications; Audit Requirements.

(a) Use of Bond Proceeds. Proceeds from the sale of the Bonds may be used only for the purposes specified in Article XIII A, Section 1(b)(3) of the California Constitution.

(b) Specification of Facilities. The Board hereby certifies that it evaluated safety, class size reduction, and information technology needs in developing the list of the Financed Facilities.

(c) Completion of Facilities. Passage of the District’s bond measure does not guarantee that all Financed Facilities listed in the Full Text, as set forth in **Exhibit A** will be completed. In addition, certain Financed Facilities projects may require state matching funds. State matching funds may be subject to appropriation by the Legislature or approval of a statewide bond measure.

(d) Performance Audit. The Board shall conduct an annual, independent performance audit to ensure that the Bond funds have been expended only on the specific Financed Facilities listed.

(e) Financial Audit. The Board shall conduct an annual, independent financial audit of the proceeds from the sale of the Bonds until all of the proceeds have been expended for the Financed Facilities.

Section 3. Government Code Accountability Requirements. Pursuant to Government Code sections 53410 and 53411, the District hereby finds or directs that:

(a) Purpose. The purpose of the Bonds is to fund the Financed Facilities, as listed in **Exhibit A**;

(b) Proceeds. The Bond proceeds shall only be used on the Financed Facilities and costs incident thereto;

(c) Accounts. All proceeds of the Bonds shall be placed in a separate account or accounts; and

(d) Annual Reports. The Assistant Superintendent of Business Services of the District shall issue an annual report to the Board containing the amount of funds collected and expended as well as the status of the Financed Facilities.

Section 4. Vote Required. Pursuant to Section 18(b) of Article XVI and Section 1 of Article XIII A of the California Constitution, the bond measure shall become effective only upon the affirmative vote of fifty-five percent (55%) of those voters voting on the measure.

Section 5. County Registrar of Voters to Conduct Election. Pursuant to Education Code section 5303, the Ventura County (the "County") Registrar of Voters ("County Registrar") is hereby requested to take all steps to prepare for and hold the election within the boundaries of the District in accordance with law and these specifications.

Section 6. Consolidation with Other Elections. Pursuant to Sections 5342, 15121, and 15266 of the Education Code and Part 3 (commencing with Section 10400) of Division 10 of the Elections Code, the County Board of Supervisors is requested to order consolidation by the County Registrar of Voters of a school bond election with the other elections to be held on the same day in the same territory or in territory that is in part the same. Pursuant to Section 10403 of the Elections Code, the Board hereby acknowledges that the consolidated election will be held and conducted in the manner prescribed by Section 10418 of the Elections Code.

Section 7. Canvass of Returns. The County Board of Supervisors is authorized to canvass the returns of the election pursuant to Section 10411 of the Elections Code.

Section 8. Services of Registrar of Voters. Pursuant to Section 5303 of the Education Code and Section 10002 of the Elections Code, the County Board of Supervisors is requested to permit the County Registrar of Voters to render all services incident to the preparation for, and holding of the election, for which services the District agrees to reimburse the County with such services to include the publication of a notice of school bond election, and the mailing of the sample ballot and tax rate statement (described in Section 9401 of the Elections Code) pursuant to the terms of Section 5363 of the Education Code and the Elections Code. Such services to include the publication of a formal notice of school bond election and the mailing of the Full Text, Abbreviated Ballot Measure (the "Abbreviated Measure"), and the tax rate statement described in Election Code Section 9401 (the "Tax Rate Statement").

Section 9. Publication of Materials. The District hereby requests the County Registrar to publish the Full Text, as set forth at **Exhibit A** attached hereto, along with the Abbreviated Measure, as set forth at **Exhibit B** attached hereto, and the Tax Rate Statement, as set forth at **Exhibit C** attached hereto, as appropriate, and to designate the measure on the ballot by a letter printed on the left margin of the square containing the Abbreviated Measure as provided in Section 13116 of the Elections Code.

Section 10. Specifications of the Election Order. The foregoing specifications of the election order are made pursuant to Section 5322 of the Education Code.

Section 11. Delivery of Specifications of the Election Order. The District's Superintendent or Assistant Superintendent of Business Services is hereby directed to deliver, a certified copy of this Resolution and the Tax Rate Statement to the County Registrar of Voters and a copy of this Resolution to the County Board of Supervisors and the County Superintendent of Schools.

Section 12. General Authorization with Respect to the Bond Election. The members of the District's Board, the Superintendent, and the other officers of the District are hereby authorized and directed, individually and collectively, without further review and action by the Board, to do any and all things, to execute, deliver, and perform any and all agreements and documents they deem necessary or advisable in order to effectuate the purposes of this Resolution, and to perform all acts necessary to place the Bond measure on the ballot, including, without limitation, to prepare and submit for inclusion in the voter information pamphlet an argument in favor of passage of the Bond measure, and making any changes to this Resolution, the Full Text, the Abbreviated Measure, or the Tax Rate Statement (hereinafter the "Ballot Documents").

In the event of any such modifications to the Ballot Documents, the Superintendent and the other officers of the District are hereby further authorized to supplement or replace the original versions of such documents with the versions modified pursuant hereto. Such modified versions shall thereafter be deemed to constitute the final, complete and approved version of the Ballot Documents, for all intents and purposes, including for delivery of the Ballot Documents to the County Registrar and other parties set forth in Section 11 above and for publication of the ballot materials set forth in Section 9 above. All actions heretofore taken by the officers and agents of the District that are in conformity with the purposes and intent of this Resolution are hereby ratified, confirmed, and approved in all respects.

Section 13. Encumbrance of Bond Funds. For the purpose of making bond funds unavailable as rent within the meaning of Education Code Section 17032, the Board hereby encumbers all funds to be generated by the sale of the Bonds in order to pay for the acquisition and construction of the Financed Facilities authorized by the ballot measure.

Section 14. State Matching Funds. Certain of the Financed Facilities require state matching funds for the completion of any phase thereof. Approval of the District's bond measure does not guarantee that the proposed Financed Facilities will be funded beyond the local revenues generated by the measure. The District's proposal for the Financed Facilities may assume receipt of matching state funds, which could be subject to appropriation by the Legislature or approval of a statewide bond measure.

Section 15. Citizens' Oversight Committee. It is the intent of the Board that a citizens' oversight committee be appointed to ensure that the proceeds of the Bonds are spent only for the specific purposes and projects identified in this Resolution. The membership requirements and procedures for such committee shall be established by the Board in accordance with the requirements of law.

Section 16. Official Intent to Reimburse Expenditures. The District intends to undertake the acquisition, construction, renovation, furnishing, and equipping of the Financed Facilities projects as described in **Exhibit A**. The District intends to use the proceeds of the Bonds described in this Resolution to finance the Financed Facilities. The District may pay certain capital expenditures (the "Reimbursement Expenditures") in connection with the Financed Facilities projects prior to the issuance of the Bonds. The District reasonably expects that Bonds in an amount not expected to exceed \$72,000,000 will be issued by it for the purpose of financing the Financed Facilities projects on a long-term basis and that certain of the proceeds of such debt obligations may be used to reimburse the District for the Reimbursement Expenditures.

The Board hereby declares the District's official intent to use a portion of the proceeds of the Bonds to reimburse the District for the Reimbursement Expenditures. The foregoing statement is a declaration of official intent that is made under and only for the purpose of establishing compliance with the requirements of Treasury Regulations Section 1.150-2.

Section 17. Tax Rate Statement. The Board hereby approves the form of the Tax Rate Statement attached hereto as **Exhibit C** and incorporated herein by reference. The District hereby requests the County Registrar of Voters to publish the Tax Rate Statement contained in **Exhibit C** as part of the ballot materials.

Section 18. Estimates Included in Ballot Materials. The Bond measure authorized by this Resolution may include certain information which is based upon reasonable assumptions and current expectations, which may include information with respect to the amount of money required to repay the Bonds, the estimated rate of the approved tax per \$100 of assessed valuation, and the period through which the proposed tax supporting repayment of the Bonds will be levied and collected. Any such estimates have been provided by the District in good faith based upon information currently available to the District. Such estimates depend on numerous variables which are subject to variation and change over the term of the District's facilities and Bond programs. The estimates and projections set forth in the District's Bond measure, including the Tax Rate Statement published in the voter information pamphlet by the County Registrar, shall not be a restriction on the tax imposed in accordance with the Bond measure and applicable law. Such estimates and projections are not intended by the Board to be restrictions on the District's Bond program, and other than the total principal amount of Bonds authorized by the Bond measure, shall not represent legal maximums or additional limitations on the issuance of the Bonds.

Section 19. Engagement of Professional Services. The firm of Isom Advisors, a Division of Urban Futures, Inc. is hereby appointed to serve as financial advisor, the firm of Raymond James is appointed to provide underwriting services, and the firm of Parker & Covert LLP, a nationally recognized bond counsel firm, is hereby appointed to serve as bond counsel and disclosure counsel, each in connection with the Bond election called by way of this Resolution, and if successful, subsequent Bond issuances (the "Proposed Bonds"). The Board ratifies existing agreements between the District and the firms identified above and on file with the District, relating to the Proposed Bonds. The Board further authorizes the Superintendent to execute new agreements with the firms identified above, in the forms presently on file with the District and relating to the Proposed Bonds.

Section 20. Effective Date. This Resolution shall take effect immediately upon its adoption.

[Signature Page Follows]

This Resolution of the Board of Trustees of the Rio Elementary School District Ordering a School Bond Election, Establishing Specifications of the Election Order, and Requesting Consolidation with Other Elections Occurring on November 8, 2022 is **approved, passed, and adopted** on June ___, 2022, by the Rio Elementary School District Board of Trustees by the following vote:

AYES:

NOES:

ABSTAIN:

ABSENT:

RIO ELEMENTARY SCHOOL DISTRICT

President of the Board of Trustees

ATTEST:

Secretary of the Board of Trustees

EXHIBIT A

FULL TEXT OF THE MEASURE

Upon the passage of Measure _____, the Rio Elementary School District (the "District") shall be authorized to issue bonds in the aggregate amount of \$72,000,000, bearing interest at rates not exceeding the statutory limit, for the purpose of funding the school facilities projects listed below under the heading "School Facilities Projects to Be Funded with Proceeds of Bonds" (the "Financed Facilities"), and other authorized expenditures as set forth herein.

Proposition 39 Bond Accountability Measures

At its June __, 2022 meeting, the Board of Trustees (the "Board") certified that it evaluated safety, class size reduction, and information technology needs in developing the list of Financed Facilities set forth below. The proceeds of the Bonds shall be used only for the specific projects identified in the list of Financed Facilities set forth below and any other authorized expenditures as set forth herein, and not for any other purpose (i.e., teacher and administrative salaries and other school operating expenses).

The District will deposit the proceeds of the bonds in a separate account. The Board is bound to conduct financial and performance audits annually to account for the Bond funds and to assure that funds have only been expended on the authorized projects. The District shall prepare and deliver an annual report to the Board containing the amount of funds collected and expended as well as the status of school facilities projects authorized to be funded by proceeds of the Bonds.

The Board will appoint a citizen's oversight committee (the "Committee") having a minimum of seven members and including at least one member active in a business organization representing the business community located within the District, one member active in a senior citizens' organization, one member active in a bona fide taxpayers' organization, one member who is the parent or guardian of a child enrolled in the District, and one member who is both a parent or guardian of a child enrolled in the District and active in a parent-teacher organization.

School Facilities Projects to Be Funded

Rio Real Elementary School Classroom and Campus Master Plan Renovation:

- Construct new classrooms to replace portables
- Construct library
- Construct Multipurpose Room (MPR) and/or gymnasium
- Renovate, upgrade, and modernize School Office
- Construct, reconstruct, upgrade, and make other improvements to outdoor learning spaces
- Construct middle grades classrooms and make other campus improvements to replace portables

Rio Plaza Elementary School Classroom and Campus Master Plan Renovation:

- Renovate, upgrade, and modernize old and outdated classrooms.
- Improve student access to computers and modern technology including adding classroom visual presentation systems.

- Renovate outdated infrastructure including plumbing, electrical, and HVAC (heating, ventilation, and air conditioning) systems.
- Make health, safety, and campus security improvements.
- Expand administration building.
- Improve student safety through a drop-off zone improvement.
- HVAC additions and improvements

District-wide

- Improve student access to computers and modern technology including adding classroom visual presentation systems.
- Renovate, upgrade, and modernize, and make other improvements to old and outdated classrooms to provide 21st Century learning environments for students.
- Make health, safety, and campus security improvements.
- Improvements to mitigate parking impacts at schools as needed.
- Construction, reconstruction, and other improvements to provide for Agricultural Education.

Additional Expenditures and Project Related Items

- Abate and remove hazardous materials identified prior or during construction.
- Address unforeseen conditions revealed by construction/modernization (such as plumbing or gas line breaks, dry rot, seismic, structural, etc.).
- Other improvements required to comply with existing building codes, including the Field Act, and access requirements of the Americans with Disabilities Act.
- Necessary site acquisition and preparation/restoration in connection with new construction, renovation or remodeling of student support facilities, or installation or removal of relocatable classrooms, including ingress and egress, removing, replacing, or installing irrigation, utility lines (such as gas lines, water lines, electrical lines, sewer lines, and communication lines), trees and landscaping, relocating fire access roads, and acquiring any necessary easements, licenses, or rights of way to the property.
- Rental or construction of storage facilities and other space on an interim basis, as needed to accommodate construction materials, equipment, and personnel, and interim classrooms (including relocatables) for students and school functions or other storage for classroom materials displaced during construction.
- Acquisition of any of the facilities on the list through temporary lease or lease-purchase arrangements, or execute purchase option under leases for any of these authorized facilities.
- For any project involving rehabilitation or renovation of a building or other facilities or the major portion of a building or other facilities, the District shall be authorized to proceed with new replacement construction instead, if the Board determines that replacement and new construction is more economically practical than rehabilitation and renovation, considering the building's or facilities' age, condition, expected remaining life, and other relevant factors.
- All work necessary and incidental to specific projects described above, including demolition of existing structures.

- Staffing and other general and administrative costs to manage and execute the Bond program, including the cost of District staff when performing work on or necessary and incidental to the Financed Facilities and other authorized Bond expenditures, as set forth herein.
- Escalation reserve for unforeseen price inflation costs.
- Program reserve for unanticipated scope costs or for unanticipated opportunities to enhance project scope or schedules.

The listed projects will be completed as needed. Approval of the District's Bond Measure does not guarantee that the proposed school facilities projects in the District that are the subject of the Bonds will be funded beyond the local revenues generated by Bond Measure. The District's proposal for the school facilities projects may assume receipt of matching state funds, which could be subject to appropriation by the Legislature or approval of a statewide bond measure. The allocation of bond proceeds may also be affected by the final costs of each project. In the absence of state matching funds, which the District will aggressively pursue to reduce the District's share of the costs of the projects, the District may not be able to complete some of the projects identified in Bond Measure.

The budget for each project is an estimate and may be affected by factors beyond the District's control. The final cost of each project will be determined as plans are finalized, construction bids are awarded and projects are completed. Based on the final costs of each project, certain of the projects described above may be delayed or may not be completed. Demolition of existing facilities and reconstruction of facilities scheduled for repair and upgrade may occur, if the Board determines that such an approach would be more cost-effective in creating enhanced and operationally efficient campuses. Necessary relocation assistance, site preparation/restoration and landscaping, may occur in connection with new construction, renovation or remodeling, or installation or removal of portable classrooms, including ingress and egress, removing, replacing, or installing irrigation, utility lines, trees and landscaping, redirecting fire access, and acquiring any necessary easements, licenses, or rights of way to the property.

Additional Specifications

Listed projects may be completed at any and all school sites where such project is determined necessary. Where economically feasible, buildings, fixtures, and equipment may be replaced rather than modernized, renovated, or repaired. Projects may include the acquisition and construction of temporary housing or other replacement structures as necessary. Each project is assumed to include its share of costs of the election and bond issuance, architectural, engineering, and similar planning costs and construction costs. In addition to the projects listed above, the Financed Facilities also include the acquisition of land, instructional, maintenance and operational furniture and equipment, payment of the costs of preparation of all facilities planning and project implementation studies, feasibility and assessment reviews, master planning, improvements, rehabilitation projects, and upgrades will be completed only as feasible, and the list of Financed Facilities does not imply a particular prioritization among such improvements, which remains the province of the Board by subsequent action.

Single Purpose. All of the purposes enumerated in this proposition shall be united and voted upon as on single proposition, pursuant to Section 15100 of the Education Code, and all the

enumerated purposes shall constitute the specific single purpose of the Bonds and proceeds of the Bonds shall be spent only for such purpose.

Other Terms of the Bonds. When sold, the Bonds shall bear interest at an annual rate not exceeding the statutory maximum. The Bonds may be issued and sold in several series and in accordance with a plan of finance determined by the Board pursuant to the requirements of law.

Project Requiring State Matching Funds. Approval of the District's Bond Measure does not guarantee that the proposed District projects that are the subject of the Measure will be funded beyond the local revenues generated by the Measure. Some of the District's projects may assume the receipt of state matching funds, which could be subject to appropriation by the Legislature or approval of a statewide Bond Measure.

EXHIBIT B

ABBREVIATED BALLOT MEASURE

The abbreviated ballot measure reads as follows:

“Without increasing estimated tax rates, shall Rio Elementary School District’s measure to improve the quality of education; modernize outdated classrooms, restrooms and facilities; make health, safety, and security improvements; provide HVAC; upgrade technology; and construct new classrooms and libraries, by authorizing \$_____ of bonds be adopted with legal rates, raising on average \$_____ per year until repaid, at approximately _____¢ per \$100 assessed value, with annual audits, independent oversight, NO money for salaries, and all money staying local?”

BONDS-YES

BONDS-NO

(75 words)

EXHIBIT C

TAX RATE STATEMENT

An election will be held in the Rio Elementary School District (the "District") on November 8, 2022, to authorize the sale of up to \$72,000,000 in bonds of the District to continue improving the quality of education in local schools and protecting the safety of the students of the District. Specifically, bond proceeds shall be utilized for the purposes of acquisition, construction, renovation, furnishing, and equipping of school facilities, support facilities, and equipment.

If the bonds are authorized and sold, debt service thereon will be payable from the proceeds of tax levies made upon the taxable property in the District. The following information is provided in compliance with sections 9400-9404 of the Elections Code of the State of California. It is anticipated that the District will sell the bonds in separate series.

1. The best estimate of the average tax rate that would be required to be levied to fund the Bonds issued during the life of the Bonds, based on estimated assessed valuations available at the time of filing of this statement, is 2.007¢ per \$100 (\$20.07 per \$100,000) of assessed valuation. The final fiscal year in which the tax is anticipated to be collected is 2058-2059.

2. The best estimate of the highest tax rate that would be required to be levied to fund the Bonds, based on estimated assessed valuations available at the time of filing of this statement, is 3.000¢ per \$100 (\$30.00 per \$100,000) of assessed valuation which would first occur in fiscal year 2046-2047.

3. The best estimate of total debt service, including principal and interest, that would be required to be repaid if all the Bonds are issued and sold is \$150,047,366.67. This estimate results in a debt service to principal ratio of 2.09:1.00, which is significantly less than the maximum ratio of 4.00:1 allowed by State law. This estimate is based on the assumption that interest rates will increase over time, and the Bonds will have a maximum term of 30 years per series.

Voters should note that the estimated tax rates are based on the *ASSESSED VALUE* of taxable property on the County's official tax rolls, *not* on the property's market value. Property owners should consult their own property tax bills to determine their property's assessed value and any applicable tax exemptions.

Attention of all voters is directed to the fact that the foregoing information is based upon the District's projections and estimates only, which are not binding upon the District. The actual tax rates and the years in which they will apply may vary from those presently estimated, due to variations from these estimates in the timing of bond sales, the amount of bonds sold and market interest rates at the time of each sale, along with actual assessed valuations over the term of repayment of the bonds.

The dates of sale and the amount of bonds sold at any given time will be determined by the District based on the need for construction funds and other factors, including the legal limitations on bonds approved by a 55% vote.

The actual interest rates at which the bonds will be sold will depend on the bond market at the time of each sale. Actual future assessed valuation will depend upon the amount and value of taxable property within the District as determined by the County Assessor in the annual assessment and the equalization process.

Dated: _____, 2022

John D. Puglisi, Ph.D.,
Superintendent
Rio Elementary School District

CERTIFICATION

I, John D. Puglisi, Secretary of the Board of Trustees of the Rio Elementary School District, Ventura County, California, do hereby certify that the foregoing is a full, true, and correct copy of a Resolution duly approved and adopted by the Board of Trustees of the District at a regular meeting held on June __, 2022, of which meeting all the members of the Board of Trustees had due notice and at which a majority thereof were present, and that at the meeting the Resolution was adopted by the following vote:

AYES:

NOES:

ABSENT:

ABSTAIN:

An agenda for the meeting was provided at least seventy-two (72) hours before the regular meeting to all members of the Board of Trustees and to all media outlets that have requested notification. Further the agenda was posted at least seventy-two (72) hours before the regular meeting at the District at 1800 Solar Drive, Oxnard, CA 93030, a location freely accessible to members of the public, and a brief description of the Resolution appeared on the agenda.

I have carefully compared the foregoing Resolution with the original minutes of the meeting on file and of record in my office, and the foregoing is a full, true, and correct copy of the original Resolution adopted at the meeting and entered in the minutes.

Dated: _____, 2022

John D. Puglisi, Ph.D.,
Secretary of the Board of Trustees
Rio Elementary School District



Agenda Item Details

Meeting	Jun 29, 2022 - RSD Regular Board Meeting
Category	8. Discussion/Action
Subject	8.3 Approval of Revised Certificated Salary Schedule reflecting 5% on Salary Increase
Access	Public
Type	Action
Preferred Date	Jun 29, 2022
Absolute Date	Jun 29, 2022
Recommended Action	District staff recommends approval of this item.
Goals	<p>Goal 5-Recruit, hire, train, and retain exemplary employees who are caring, committed, collaborative, creative and critical thinkers.</p> <p>Goal 4-Prepare students to be college and career ready through technology and innovation that facilitates collaboration, creativity, critical thinking and communication.</p> <p>Goal 3-Create welcoming and safe environments where students attend and are connected to their school</p> <p>Goal 1-Improved student achievement at every school and every grade in all content areas</p>

Public Content

Speaker: Rebecca Rocha, Director of Human Resources

Rationale: The Rio School District has reached an agreement for a 5% salary increase retroactive to July 1, 2021 with the Rio Teachers' Association.

The current certificated salary schedule does not reflect the salary inclusive of the 5% increase and a new certificated salary schedule has been developed with the adjustment to account for the 5% increase moving forward.

[Certificated Teacher Salary Schedule 2022-2023.pdf \(466 KB\)](#)

Administrative Content

Executive Content



**RIO SCHOOL DISTRICT
2022/2023**

**CERTIFICATED TEACHER SALARY SCHEDULE
185 Work Days**

CLASS	I		II	III	IV	V
	BA permit	BA credential	B.A.+ 30	B.A. + 45 or M.A.	B.A. + 60 or M.A.+ 15	B.A. +75 incl. M.A. or M.A. +30
STEP 1	49,851	53,712	55,818	57,926	60,809	64,788
2	52,581	54,766	56,871	58,844	62,941	67,060
3	53,393	55,818	57,926	60,919	65,139	69,400
4	55,273	56,871	58,730	63,042	67,419	71,831
5	57,211	57,926	60,793	65,256	69,780	74,360
6	57,211	60,287	62,914	67,535	72,217	76,953
7	57,211	62,384	65,115	69,900	74,758	79,647
8	57,211	64,578	67,404	72,335	77,356	82,429
9	57,211	66,841	69,762	74,885	80,077	85,319
10	57,211	66,841	72,203	77,498	82,883	88,314
11	57,211	66,841	72,203	80,225	85,783	91,405
12	57,211	66,841	72,203	82,372	91,176	97,142

Anniversary Increments for years of service in the Rio School District

14th through 18th year	4.60%	86,161	95,371	101,610
19th through 24th year	6.40%	87,644	97,012	103,359
25th through 27th year	7.90%	88,880	98,379	104,816
28th Year	10%	90,609	100,294	106,856
29th Year	11%	91,433	101,206	107,827
30th Year	12%	92,257	102,118	108,799

Board Approved:

Effective 7-1-2022 5% salary increase

THE FOLLOWING CLASSIFICATIONS ARE USED IN DETERMINING TEACHER SALARIES

Class I Permit	Appropriate permit: BA degree.
Class I Credential	Appropriate credential: BA degree
Class II Class III	BA degree plus 45 semester hours subsequent to granting of BA BA degree plus 45 semester hours subsequent to granting of BA degree, or MA/MS degree.
Class IV	BA degree plus 60 semester hours subsequent to granting of BA degree, or MA plus 15 semester hours subsequent to granting of MA degree
Class V	BA degree plus 75 semester hours subsequent to granting of BA degree, including MA degree or a Specialist Credential; or MA degree plus 30 semester hours subsequent to granting of MA OR degree or Specialist Credential plus 30 semester units subsequent to granting of Specialist Credential. A Specialist Credential is defined, as one which requires a credential as a prerequisite to the Specialist Credential. Examples of Specialist Credential are: Bilingual Cross- Cultural , Reading Specialist, Early Childhood, Gifted, Health Science, Mathematics, Special Education: Learning Handicapped, Severely Handicapped.

Credits for increments will only be given for upper division or graduate work unless specifically approved by the Superintendent or designee. Teachers will be given credit or up to six (6) years of prior teaching experience in public schools. Starting step maximum is step 7 beginning in 1999/2000

Upon the approval of Superintendent, experience credit will be given on salary schedule for full-time, full-term experience in private schools as well as public school, provided the teacher held a valid appropriate state public school teacher credential at the time of the teaching experience.

To achieve credit for a year of teaching experience, a teacher must have taught for at least 75% of said year.

The teacher's work year is determined by contract.

Anniversary increments are added to the salary schedule at the beginning of the 14th, 19th, 25th, and 28th years of service to the Rio School District.



Agenda Item Details

Meeting	Jun 29, 2022 - RSD Regular Board Meeting
Category	8. Discussion/Action
Subject	8.4 Approval of 2022-2023 Single Plan for Student Achievement for all Nine Schools
Access	Public
Type	Action
Fiscal Impact	No
Budgeted	No
Budget Source	Federal and State categorical funding
Recommended Action	Staff recommends board approval of 2022-2023 SPSAs.

Public Content

Speaker: Oscar Hernandez, Assistant Superintendent Educational Services

Rationale:

Educational Services department provided an overview presentation of all nine plans at the May 18 board meeting. We are requesting approval of the 2022-2023 single plan for student achievement for all nine schools.

A Single Plan for Student Achievement (SPSA) must be written and implemented at all schools to raise students' academic performance, improve the educational program, and create a cycle of continuous improvement for schools. It requires collection and analysis of student performance data, setting priorities for program improvement, rigorous use of effective solution strategies, and ongoing monitoring of results.

[2022_School_Plan_for_Student_Achievement_Rio_Del_Mar_Elementary_School_20220616.pdf \(496 KB\)](#)

[2022_School_Plan_for_Student_Achievement_Rio_Del_Norte_Elementary_School_20220616.pdf \(497 KB\)](#)

[2022_School_Plan_for_Student_Achievement_Rio_del_Sol_Elementary_School_20220616.pdf \(796 KB\)](#)

[2022_School_Plan_for_Student_Achievement_Rio_Del_Valle_Middle_School_20220616.pdf \(415 KB\)](#)

[2022_School_Plan_for_Student_Achievement_Rio_Lindo_Elementary_School_20220616.pdf \(478 KB\)](#)

[2022_School_Plan_for_Student_Achievement_Rio_Real_Elementary_School_20220616.pdf \(574 KB\)](#)

[2022_School_Plan_for_Student_Achievement_Rio_Real_Elementary_School_20220616.pdf \(574 KB\)](#)

2022_School_Plan_for_Student_Achievement_Rio_Rosales_Elementary_School_20220616.pdf (476 KB)

2022_School_Plan_for_Student_Achievement_Rio_Vista_Middle_School_20220616.pdf (506 KB)

Administrative Content

Executive Content

Reports can be found on the
district website

rioschools.com

8.5



Agenda Item Details

Meeting	Jun 29, 2022 - RSD Regular Board Meeting
Category	8. Discussion/Action
Subject	8.5 Approval of the Local Control Accountability Plan
Access	Public
Type	Action
Fiscal Impact	Yes
Dollar Amount	11,652,563.00
Budgeted	Yes
Budget Source	LCFF
Recommended Action	Staff recommends approval of local control accountability plan.

Public Content

Speaker: Oscar Hernandez, Assistant Superintendent Educational Services

Rationale:

Prior to adopting the LCAP, the governing board held a public hearing on June 22, 2022, to solicit recommendations and comments from the public regarding the specific LCAP actions and expenditures.

The Superintendent has satisfied all the statutory requirements and requests the Board of Trustees to approve the Rio School District Local Control Accountability Plan.

[2022_Local_Control_and_Accountability_Plan_Rio_School_District_20220614.pdf \(1,056 KB\)](#)

Administrative Content

Executive Content

Reports can be found on the
district website

rioschools.com

8.6



Agenda Item Details

Meeting	Jun 29, 2022 - RSD Regular Board Meeting
Category	8. Discussion/Action
Subject	8.6 Adopted Budget for 2022/2023
Access	Public
Type	Action
Budget Source	All District Funds
Recommended Action	Staff recommends approval of the Adopted Budget for 2022/2023
Goals	<p>Goal 1-Improved student achievement at every school and every grade in all content areas</p> <p>Goal 2-Engage parents and other District stakeholders in the development of meaningful partnerships to support student learning.</p> <p>Goal 3-Create welcoming and safe environments where students attend and are connected to their school</p> <p>Goal 4-Prepare students to be college and career ready through technology and innovation that facilitates collaboration, creativity, critical thinking and communication.</p> <p>Goal 5-Recruit, hire, train, and retain exemplary employees who are caring, committed, collaborative, creative and critical thinkers.</p>

Public Content

Speaker:
Wael Saleh, Assistant Superintendent, Business Services

Rationale:
The Rio School District must adopt a budget by July 1 of every year to allow for payments of any liabilities and expenditures, such as salaries, supplies and services. The attached documents represent the District's proposed 2022-23 budget.

As required by law, a public hearing for the 2022-23 budget was held on June 22, 2022. At that meeting, no public comment was given.

This is the link: [Budget Adoption Presentation](#) to the presentation of the proposed budget presented by Assistant Superintendent Wael Saleh during the June 22, 2022 Board Meeting.

The following State Accounting Software forms are considered to be part of Rio School District's 2022-23 budget.

CB	Budget Certification	350	County School Facility Fund
CC	Workers' Compensation Certification	490	Capital Project Fund for Blended Projects
TC	Table of Contents	510	Bond Interest and Redemption
010	General Fund	510A	Bond Indebtedness
130	Child Nutrition Services Fund	520	Debt Service Fund - CFD
140	Deferred Maintenance Fund	ADA	Average Daily Attendance
200	Special Reserve for Retiree Benefits	MYP	Multi Year Projection
210	Building Fund	CS	Criteria and Standards
250	Capital Facilities Fund		

This report has been available for review since June 10, 2022 at the Rio School District office located at 1800 Solar Drive, 3rd Floor, Oxnard, CA and on the Rio School District website.

[NOTICE OF PUBLIC HEARING of BUDGET June 22, 2022.pdf \(433 KB\)](#)

[Budget Summary for Board Packet.pdf \(840 KB\)](#)

[SACS COMBINED.pdf \(1,746 KB\)](#)

Administrative Content

Executive Content

RIO SCHOOL DISTRICT
GENERAL FUND SUMMARY (FUND 01)
REVENUE, EXPENDITURES & CHANGES IN FUND BALANCE
2022-23 Preliminary Budget

	Unrestricted	Special Education	Categorical Programs	Total
A) REVENUES				
LCFF- Base Grant	\$47,488,128	\$0	\$0	\$47,488,128
LCFF- Supplemental/Concentration Grant	10,965,728	0	0	10,965,728
Federal Revenues	0	1,104,789	5,240,207	6,344,996
Other State Revenues	8,087,815	0	9,727,152	17,814,967
Local Revenues	463,314	4,025,857	129,276	4,618,447
TOTAL REVENUES	\$67,004,985	\$5,130,646	\$15,096,635	\$87,232,266
B) EXPENDITURES				
Certificated Salaries	\$24,296,069	\$3,232,424	\$1,894,884	\$29,423,377
Classified Salaries	7,673,626	2,637,272	\$2,204,056	12,514,954
Employee Benefits	15,335,178	2,638,280	\$1,763,265	19,736,723
Books and Supplies	1,365,953	169,490	\$2,497,065	4,032,508
Services and Operating Expenses	5,761,782	2,655,403	\$3,435,018	11,852,203
Capital Outlay	74,915	0	\$0	74,915
Other Outgo	1,908,965	0	\$0	1,908,965
Direct Support/Indirect Costs	(665,994)	27,859	\$281,857	(356,278)
TOTAL EXPENDITURES	\$55,750,494	\$11,360,728	\$12,076,145	\$79,187,367
EXCESS (DEFICIENCY) OF REVENUES OVER EXPENDITURES BEFORE OTHER FINANCING SOURCES AND USES				
C) AND USES	\$11,254,491	(\$6,230,082)	\$3,020,490	\$8,044,899
D) OTHER FINANCING SOURCES/USES				
Interfund Transfer In	0	\$0	\$0	\$0
Interfund Transfer Out	0	0	0	0
Other Sources	108,138	0	0	108,138
Contributions/Flexibility Transfers	(8,156,026)	5,818,163	2,337,863	0
TOTAL OTHER FINANCING SOURCES/USES	(\$8,047,888)	\$5,818,163	\$2,337,863	\$108,138
E) NET INCREASE (DECREASE) IN FUND BALANCE				
	\$3,206,603	(\$411,919)	\$5,358,353	\$8,153,037
F) BEGINNING FUND BALANCE				
	\$4,013,576	\$411,919	\$3,624,352	\$8,049,847
G) ENDING FUND BALANCE				
	\$7,220,179	\$0	\$8,982,705	\$16,202,884
H) COMPONENTS OF ENDING FUND BALANCE				
a) Designated for:				
Revolving Cash	\$5,000	\$0	\$0	\$5,000
Stores/Prepaid Expenditures	25,000	0	0	25,000
Legally Restricted Routine Maintenance	0	0	261,491	261,491
Carryover for Unspent Funds	3,997,662	0	8,721,214	12,718,876
Assigned for Unspent LCAP Funds	0	0	0	0
Total Designations	\$4,027,662	\$0	\$8,982,705	\$13,010,367
b) Reserve:				
State Mandated Reserve (3%)	2,375,621	\$0	\$0	\$2,375,621
Unassigned Reserve	816,896	0	0	816,896
Total Reserve (\$)	\$3,192,517	\$0	\$0	\$3,192,517
Total Reserve (%)	4.03%	0.00%	0.00%	4.03%
ENDING FUND BALANCE (a + b)	\$7,220,179	\$0	\$8,982,705	\$16,202,884

**Rio School District
2022-23 Preliminary Budget
Multi-Year Projection Assumptions**

Assumption	2022-23	2023-24	2024-25
Revenues:			
Projected Enrollment	5000	4930	4834
Projected Attendance Rate	95%	95%	95%
Projected Average Daily Attendance (ADA)	4750	4684	4592
Funded ADA Using 3 years Average	4996	4880	4742
Cost of Living Adjustment	6.56%	4.02%	3.61%
Additional Augmentation	3.00%	0.00%	0.00%
LCFF Calculator	FCMAT	FCMAT	FCMAT
One Time Funds	\$ 7,069,800	\$ -	\$ -
Restricted Lottery Revenues Per ADA	\$ 65	\$ 65	\$ 65
Unrestricted Lottery Per ADA	\$ 163	\$ 163	\$ 163
Expenditures:			
Step and Column Adjustments	Included	1.50%	1.50%
Salary Increases/Settlements	2% Ongoing	0.00%	0.00%
Certificated Changes	17 FTE Less	None	None
Classified Staffing Changes	None	None	None
Administrator Staffing Changes	None	None	None
STRS	19.10%	19.10%	19.10%
PERS	25.37%	25.20%	24.60%
Cost of Health Increase	Actual Cost	5%	5%
One Time Funds in Expenditures	\$ 3,072,138	\$ -	\$ -
Utilities	Included	5%	5%

**Rio School District
Multi-Year Projections
2022-23 Preliminary Budget**

		2022-23 Preliminary Budget	2023-24	2024-25
	Description			
	Funded Average Daily Attendance	4,996	4,880	4,742
A	Revenues and Other Financing Sources:			
	1 LCFF: Base Grant	\$47,488,128	\$48,888,430	\$49,420,449
	LCFF: Supp/Concent	10,965,728	9,645,472	8,357,643
	2 Federal Revenues	6,344,996	2,432,051	2,432,051
	3 Other State Revenues	17,814,967	2,734,787	2,844,725
	4 Other Local Revenues	4,618,447	4,618,447	4,618,447
	5 Other Financing Sources	-	-	-
	6 Transfer in from Other Funds	108,138	110,301	112,507
	7 Total Revenues and Other Financing Sources	87,340,404	68,429,488	67,785,822
B	Expenditures and Other Financing uses:			
	1 Certificated Salaries			
	a. Base Salaries	29,423,377	29,423,377	28,178,946
	b. Projected Step and Column Adjustment	0	416,438	422,684
	c. Cost of Living Adjustment	-	-	-
	d. Other Adjustments	-	(1,660,869)	-
	e. Total Certificated Salaries	29,423,377	28,178,946	28,601,630
	2 Classified Salaries			
	a. Base Salaries	12,514,954	12,514,954	11,783,131
	b. Projected Step and Column Adjustment	-	174,135	176,747
	c. Cost of Living Adjustment	-	-	-
	d. Other Adjustments	-	905,958	-
	e. Total Classified Salaries	12,514,954	11,783,131	11,959,878
	3 Employee Benefits:			
	a. STRS	5,413,076	5,382,179	5,462,909
	b. PERS	3,281,370	2,969,349	2,942,130
	c. FICA and Medicare	1,382,442	1,310,004	1,329,654
	d. Health and Welfare	6,822,399	7,163,519	7,521,695
	e. Unemployment	203,024	199,810	81,123
	f. Worker Comp	825,580	795,241	807,170
	g. Retiree Benefits	1,368,832	1,389,364	1,410,205
	h. Cost of Living Adjustments	-	-	-
	i. Other Benefits	440,000	(205,958)	(205,958)
	j. Total Benefits	19,736,723	19,003,509	19,348,928
	4 Books and Supplies	4,032,508	3,004,307	3,004,307
	5 Services and Other Operating Expenditures	11,852,203	9,911,020	9,985,622
	6 Capital Outlay	74,915	74,915	74,915
	7 Other outgo	1,908,965	1,908,965	1,908,965
	8 Indirect costs	(356,278)	(200,000)	(200,000)
	9 Other Financing Uses	-	-	-
	10 Proposed Budget Cuts	-	-	(920,036)
	11 Other Adjustments	-	5,910,567	(3,072,138)
	12 Total Expenditures and Financing Uses	79,187,367	79,575,359	70,692,071
C	Net Increase (Decrease) in Fund Balance	\$8,153,037	(\$11,146,871)	(\$2,906,248)
D	Fund Balance			
	1 Net Beginning Balance	8,049,847	16,202,884	5,057,013
	Total Components of Ending Fund Balance	\$16,202,884	\$5,057,013	\$2,150,764
E	Available Reserves- Unrestricted Only			
	General Fund:			
	Revolving Cash/Stores	30,000	30,000	30,000
	Legally Restricted/Carryover	8,982,705	0	(0)
	Carryover of One time Unrestricted Funds	3,997,662	-	-
	Designated for Economic Uncertainties	2,375,621	2,387,261	2,120,762
	Undesignated/ Unappropriated Amount	816,896	2,639,751	1
	Total Available Reserve - by Amount	\$16,202,884	5,057,013	2,150,763
	Total Available Reserve - by Percent	4.03%	6.32%	3.00%

Multi-Year Projection Unrestricted

Description	2022-23 Preliminary Budget	2023-24	2024-25
Revenues and Other Financing Sources:			
LCFF: Base	\$47,488,128	\$48,888,430	\$49,420,449
LCFF: Supp/Conc	10,965,728	9,645,472	8,357,643
Federal Revenues	-	-	-
Other State Revenues	8,087,815	1,072,784	1,115,910
Other Local Revenues	463,314	463,314	463,314
Other Financing Sources	(8,156,026)	(8,624,444)	(8,723,450)
Transfer In	108,138	110,301	112,507
Total Revenues and Other Financing Sources	\$58,957,097	\$ 51,555,857	50,746,373
Expenditures and Other Financing uses:			
Certificated Salaries			
a. Base Salaries	\$24,296,069	24,296,069	24,660,510
b. Projected Step and Column Adjustment	-	364,441	369,908
c. Cost of Living Adjustment	-	-	-
d. Other Adjustments	-	-	-
e. Total Certificated Salaries	24,296,069	24,660,510	25,030,418
Classified Salaries			
a. Base Salaries	7,673,626	7,673,626	7,788,730
b. Projected Step and Column Adjustment	-	115,104	116,831
c. Cost of Living Adjustment	-	-	-
d. Other Adjustments	-	-	-
e. Total Classified Salaries	7,673,626	7,788,730	7,905,561
Employee Benefits:			
a. STRS	4,575,769	4,710,157	4,780,808
b. PERS	1,879,770	1,962,760	1,944,768
c. FICA and Medicare	892,427	953,415	967,716
d. Health and Welfare	5,603,442	5,883,614	6,177,795
e. Unemployment	152,036	162,246	65,872
f. Worker Comp	619,923	645,737	655,423
g. Retiree Benefits	1,171,811	1,189,388	1,207,229
h. Cost of Living Adjustments	-	-	-
i. Other Benefits	440,000	-	-
j. Total Benefits	15,335,178	15,507,318	15,799,611
Books and Supplies	1,365,953	1,365,953	1,365,953
Services and Other Operating Expenditures	5,761,782	5,832,832	5,907,434
Capital Outlay	74,915	74,915	74,915
Other outgo	1,908,965	1,908,965	1,908,965
Indirect costs	(665,994)	(348,061)	(348,061)
Other Financing Uses	-	-	-
Proposed Budget Cuts	-	-	(920,036)
Other Adjustments (Elimination of One time Expense)	-	(3,072,138)	(3,072,138)
Total Expenditures and Financing Uses	55,750,494	53,719,024	53,652,621
Net Increase (Decrease) in Fund Balance	3,206,603	(2,163,167)	(2,906,248)
Fund Balance			
Net Beginning Balance	4,013,576	7,220,179	5,057,012
Adjustment to Beginning Balance	-	-	-
e. Total Components of Ending Fund Balance	7,220,179	5,057,012	2,150,763
Available Reserves			
General Fund:			
Revolving Cash/Stores	30,000	30,000	30,000
Carryover of Unspent One Time Funds	3,997,662	-	-
Designated for Economic Uncertainties	2,375,621	2,387,261	2,120,762
Undesignated/ Unappropriated Amount	816,896	2,639,751	1
Total Available	7,220,179	5,057,012	2,150,763

Multi-Year Projection Restricted

	2022-23 Preliminary Budget	2023-24	2024-25
Description			
A Revenues and Other Financing Sources:			
1 LCFF/Revenue Limit:	\$0	\$0	\$0
LCFF: Supp/Conc	-	-	-
2 Federal Revenues	6,344,996	2,432,051	2,432,051
3 Other State Revenues	9,727,152	1,662,003	1,728,815
4 Other Local Revenues	4,155,133	4,155,133	4,155,133
5 Other Financing Sources	8,156,026	8,624,444	8,723,450
6 Total Revenues and Other Financing Sources	\$28,383,307	16,873,631	17,039,449
B Expenditures and Other Financing uses:			
1 Certificated Salaries			
a. Base Salaries	\$5,127,308	5,127,308	3,518,436
b. Projected Step and Column Adjustment	-	51,997	52,777
c. Cost of Living Adjustment	-	-	-
d. Other Adjustments	-	(1,660,869)	-
ESSER III Plan For Certificated			
e. Total Certificated Salaries	5,127,308	3,518,436	3,571,212
2 Classified Salaries			
a. Base Salaries	4,841,328	4,841,328	3,994,401
b. Projected Step and Column Adjustment	-	59,031	59,916
c. Cost of Living Adjustment	-	-	-
d. Other Adjustments	-	(905,958)	-
e. Total Classified Salaries	4,841,328	3,994,401	4,054,317
3 Employee Benefits:			
a. STRS	837,307	672,021	682,102
b. PERS	1,401,600	1,006,589	997,362
c. FICA and Medicare	490,015	356,589	361,938
d. Health and Welfare	1,218,957	1,279,905	1,343,900
e. Unemployment	50,988	37,564	15,251
f. Worker Comp	205,657	149,505	151,747
g. Retiree Benefits	197,021	199,976	202,976
h. PERS Reduction	-	-	-
i. Other Benefits/Adjustments	-	(205,958)	(205,958)
j. Total Benefits	4,401,545	3,496,191	3,549,318
4 Books and Supplies	2,666,555	1,638,354	1,638,354
5 Services and Other Operating Expenditures	6,090,421	4,078,188	4,078,188
6 Capital Outlay	-	-	-
7 Other outgo	-	-	-
8 Indirect costs	309,716	148,061	148,061
9 Other Financing Uses	-	-	-
10 Other Adjustments	-	8,982,705	-
11 Total Expenditures and Financing Uses	23,436,873	25,856,335	17,039,449
C Net Increase (Decrease) in Fund Balance	4,946,434	(8,982,705)	(\$0)
D Fund Balance			
1 Net Beginning Balance	\$4,036,271	\$8,982,705	\$0
Adjustment to Beginning Balance	-	-	-
e. Total Components of Ending Fund Balance	8,982,705	0	(\$0)
E Available Reserves			
General Fund:			
a. Revolving Cash/Stores	-	-	-
b. Legally Restricted/Carryover	8,982,705	0	(0)
c. Designated for Economic Uncertainties	-	-	-
d. Undesignated/ Unappropriated Amount	-	-	-
Total Available	\$8,982,705	\$0	(\$0)



PLEASE POST ON FRIDAY, JUNE 10, 2022

**RIO SCHOOL DISTRICT
NOTICE OF PUBLIC HEARING
2022/23 BUDGET**

June 22, 2022 6:00 p.m.

The Governing Board of the Rio School District will hold a Public Hearing to take testimony from the public on the District's budget for the 2022/23 Fiscal Year.

Copies of the 2022/23 Budget report for the Fiscal Year 2022/23 are available at the Rio School District Office located at 1800 Solar Drive, 3rd Floor, Oxnard, CA 93030 from June 10, 2022 to June 22, 2022. Office hours are Monday through Friday, 8:00 a.m. to 4:00 p.m. (excluding holidays).

The public hearing will be held during the Governing Board meeting of the Rio School District to be held on Wednesday, June 22, 2022 at 6:00 p.m.



EDUCATING LEARNERS FOR THE 21ST CENTURY

2022-23 Proposed Budget

Wael Saleh, CPA, MBA
Assistant Superintendent/ CBO

Budget Cycle

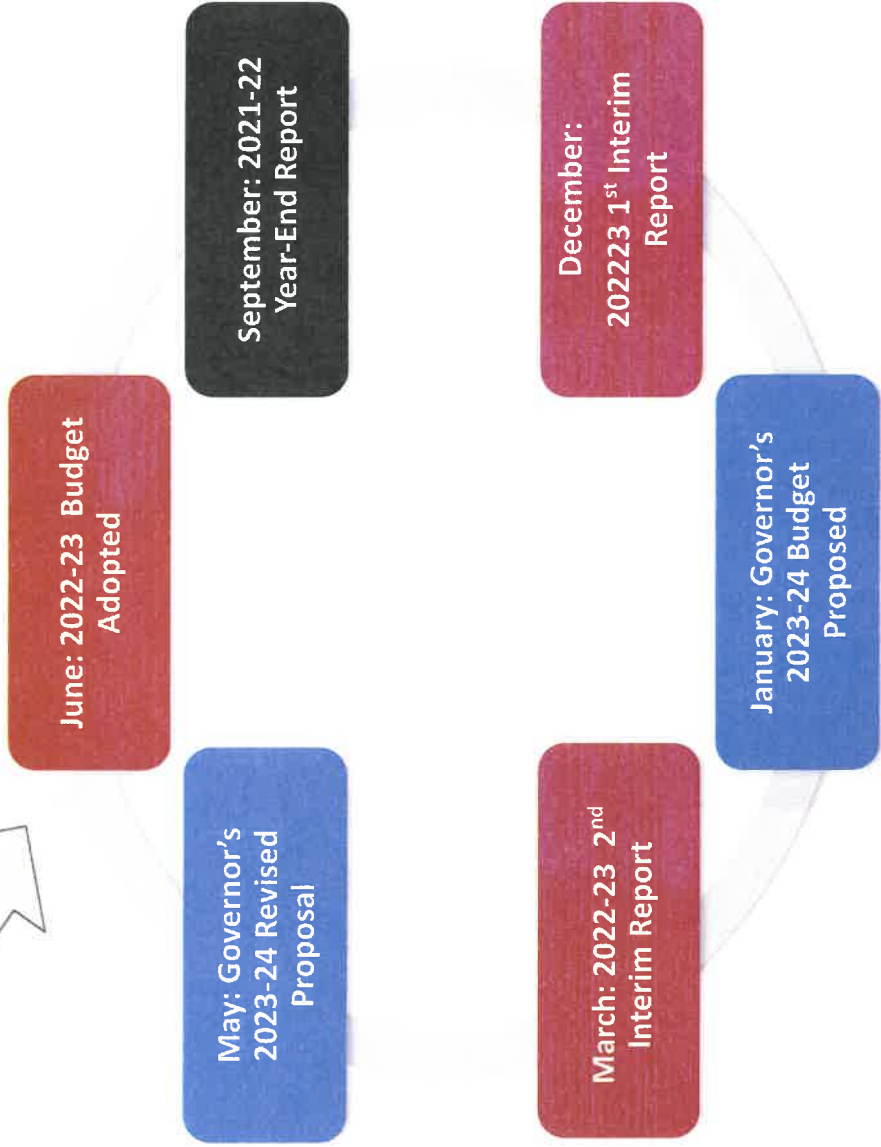
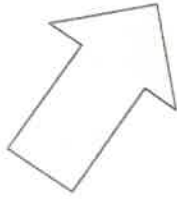

Next year	Current Year	Last year
-----------	--------------	-----------

Budget Narrative

- State Budget is not final yet
- Legislature proposals are better than the governor proposal
- **2022-23 Proposed Budget**
 - Projected Positive Operations
 - 6.56% state COLA
 - 3% additional LCFF Augmentation
 - Funded ADA 3-year- average Assistant
 - Significant One time Funds
 - Unrestricted \$7M
 - Expanded Learning Opportunity Program (ELOP) \$8.2M
 - Projected 4.03% Ending Balance
- **MYP:2023-24 and 2024-25**
 - Operational Structural Deficit
 - 4.02% and 3.61 COLAs
 - Declining Enrollment
 - Funded ADA 3-year- average Assistant
 - Significant increase in Cost for Step/column, Payroll Taxes and Benefits
 - Budget reduction is needed in the 2024-25
 - Projected 6.32% and 3% Ending balance prospectively

REVENUES CHART
2022-23 PROPOSED BUDGET

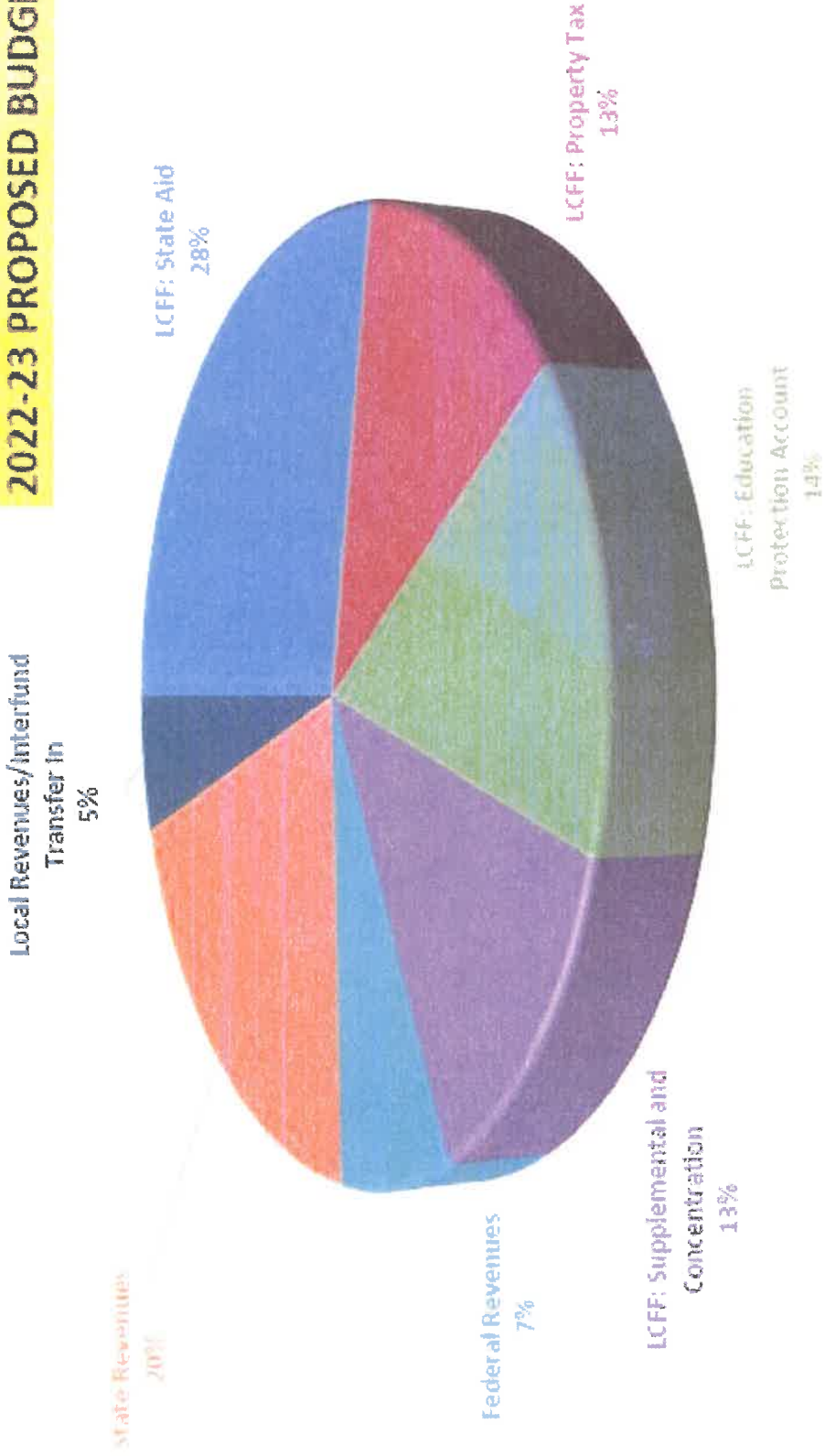

LCFF Calculation

LOCAL CONTROL FUNDING FORMULA - 2022-23 Proposed Budget Modelin

LCFF ENTITLEMENT CALCULATION

Calculation Factors	COLA & Augmentation		Base Grant Provision		Unduplicated Pupil Percentage		Total
	ADA	Base	Grade Span	Supplemental	Concentration	Concentration	
Grades TK-3	2,164.53	\$ 8,867	\$ 922	\$ 1,361	\$ 924	\$ 26,134,464	
Grades 4-6	1,686.80	9,000		1,251	649	18,724,759	
Grades 7-8	1,144.79	9,267		1,288	875	13,085,030	
Grades 9-12	-	10,739	279	1,532	1,040	-	
Subtract Necessary Small School ADA and Funding	-	-	-	-	-	-	
Total Base, Supplemental, and Concentration Grant	\$ 44,982,825	\$ 1,995,700	\$ 6,531,894	\$ 4,433,834	\$ 57,944,253		
RES Allowance							
TOTAL BASE	4,996.12	\$ 44,982,825	\$ 1,995,700	\$ 6,531,894	\$ 4,433,834	\$ 57,944,253	
ADD-ONS:							
Targeted Instructional Improvement Block Grant						\$ 169,087	
Home-to-School Transportation						132,354	
Small School District Bus Replacement Program						-	
Transitional Kindergarten (2022-23 forward)						208,162	
ECONOMIC RECOVERY TARGET PAYMENT							
LCFF ENTITLEMENT						\$ 58,453,856	

**EXPENDITURES CHART
2022-23 PROPOSED BUDGET**

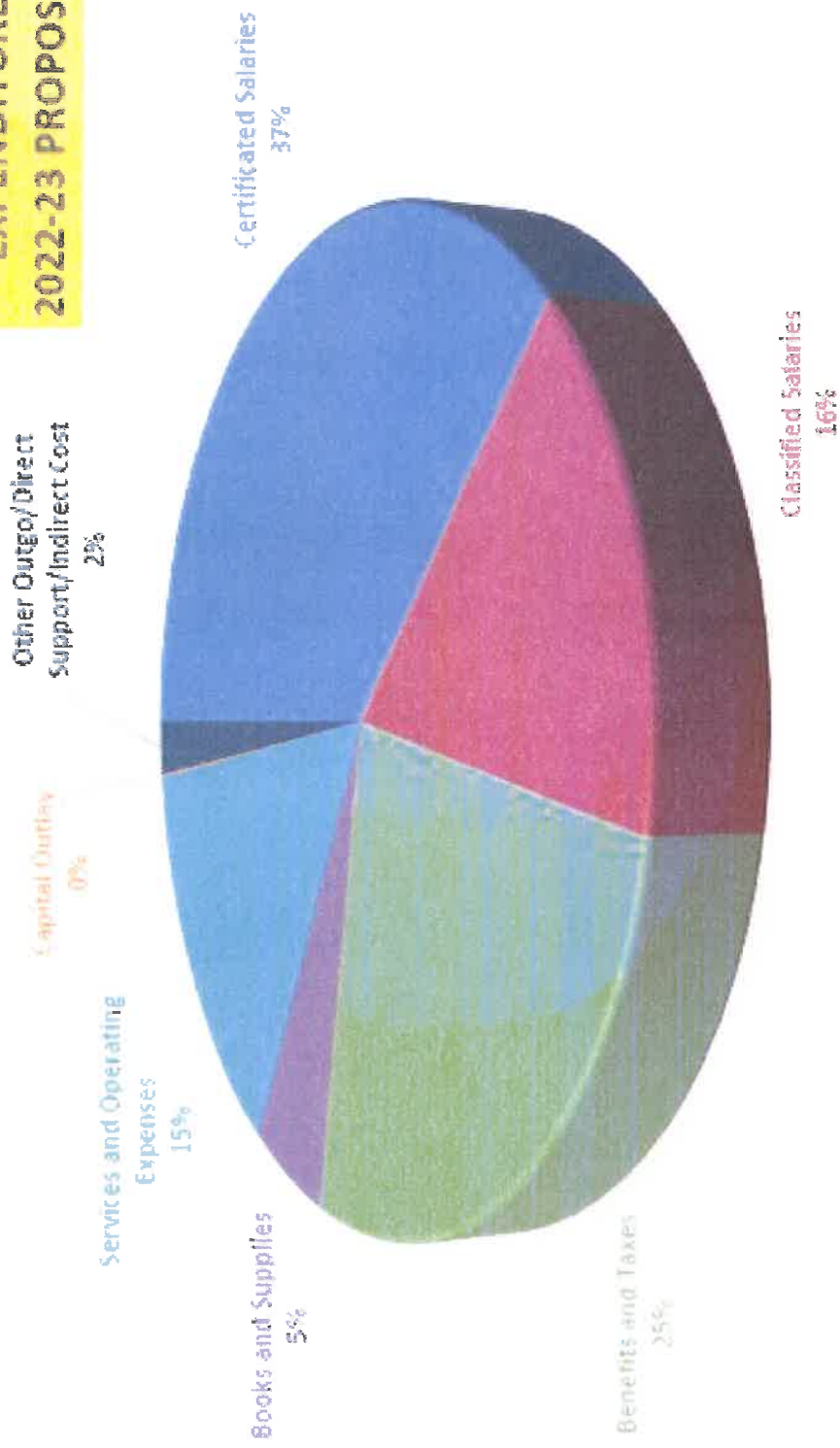

LCFF Base Revenues

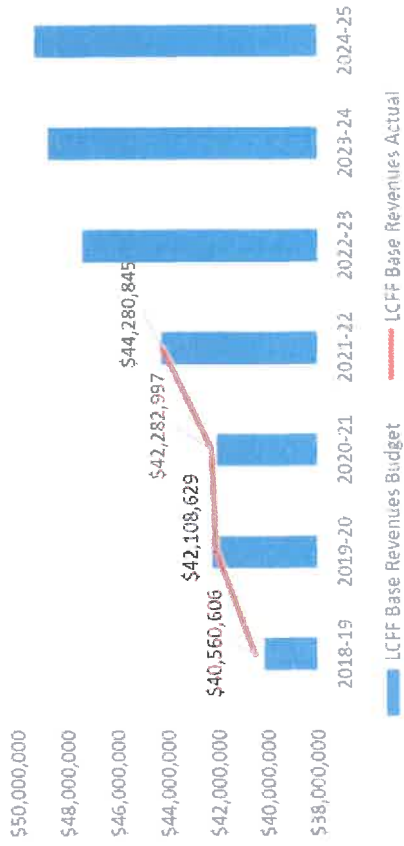

LCFF LCAP Revenues

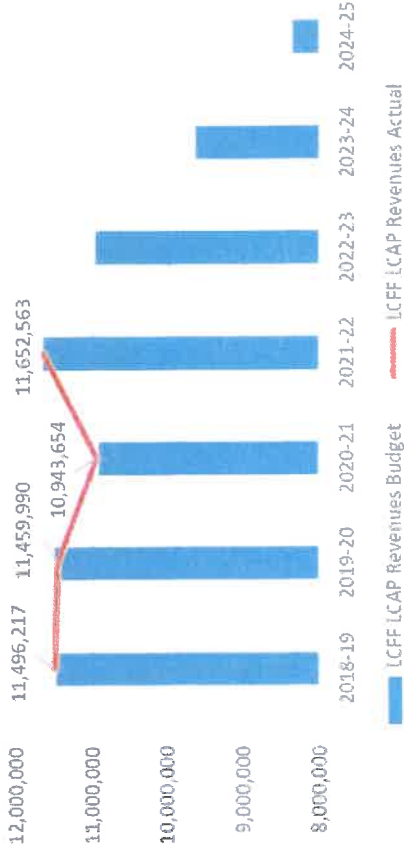

LCFF Total Revenues

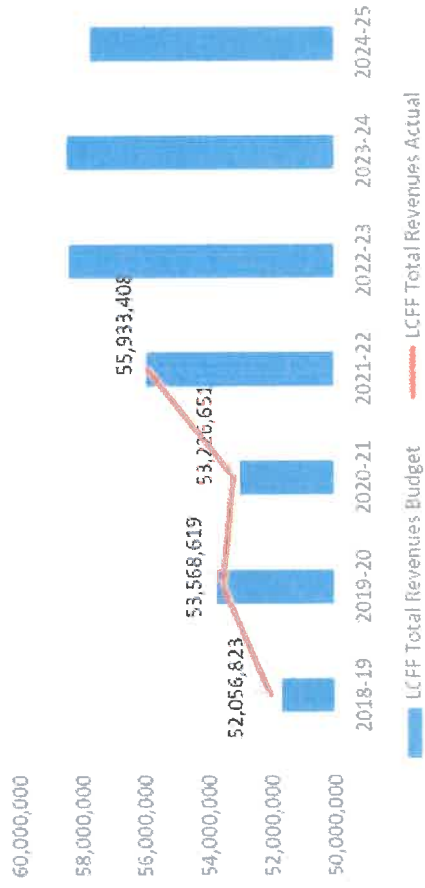

Certificated Salaries

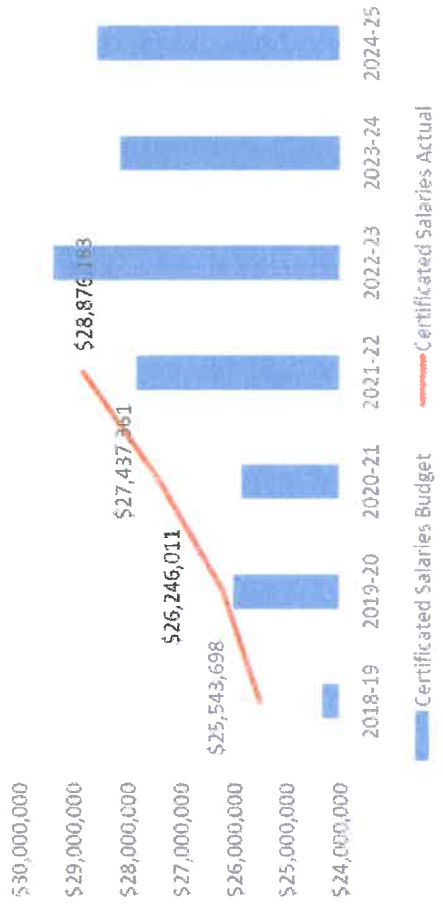

Classified Salaries

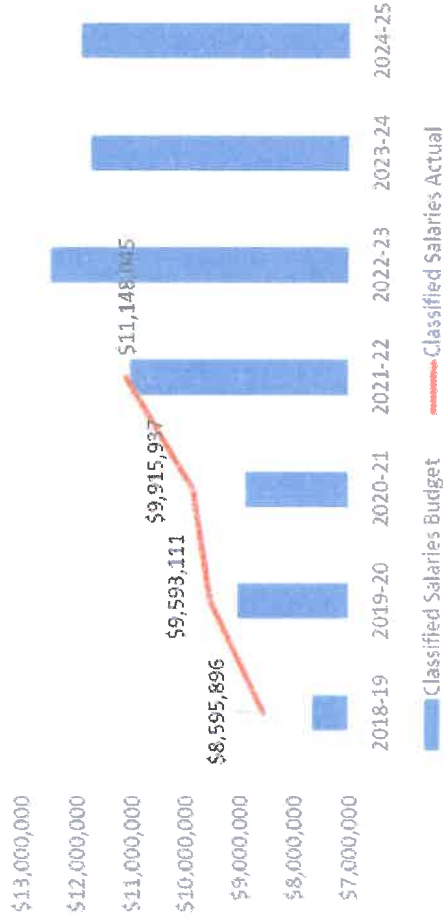

Employee Benefits



Sum of Books, supplies & services



[Budget Summary Link](#)



Summary of Other Funds: 2022-23 Budget

- **Child Nutrition Fund (Fund13):**
 - Strong Ending Balance of \$2.3M
- **Special Reserve Fund (Fund 20):**
 - Depleted: Zero Projected Ending Balance
- **Bond Fund (Fund 21):**
 - Projected \$2M Ending balance BUT DEPENDS ON CONSTRUCTION
- **Developer Fees Fund (Fund 25):**
 - Big Part will be used for RDV Expansion Project
 - Projected \$1.6M Ending Balance
- **State Matching Fund Fund (35):**
 - Projected to receive \$11.6M Matching Fund
 - Use funds for construction projects
 - \$877K Projected Ending Balance
- **CFD Fund (Fund 49):**
 - \$429K Projected Ending Balance

Questions??

9.2



Agenda Item Details

Meeting Jun 29, 2022 - RSD Regular Board Meeting
Category 9. Consent
Subject 9.2 Approval of the Minutes of the Regular Board Meeting of June 22, 2022
Access Public
Type

Public Content

Speaker: John Puglisi, Ph.D., Superintendent

Rationale:

Staff recommends approval of the Minutes of the Regular Board Meeting of June 22, 2022.

[MinReg06222022.pdf \(61 KB\)](#)

Administrative Content

Executive Content

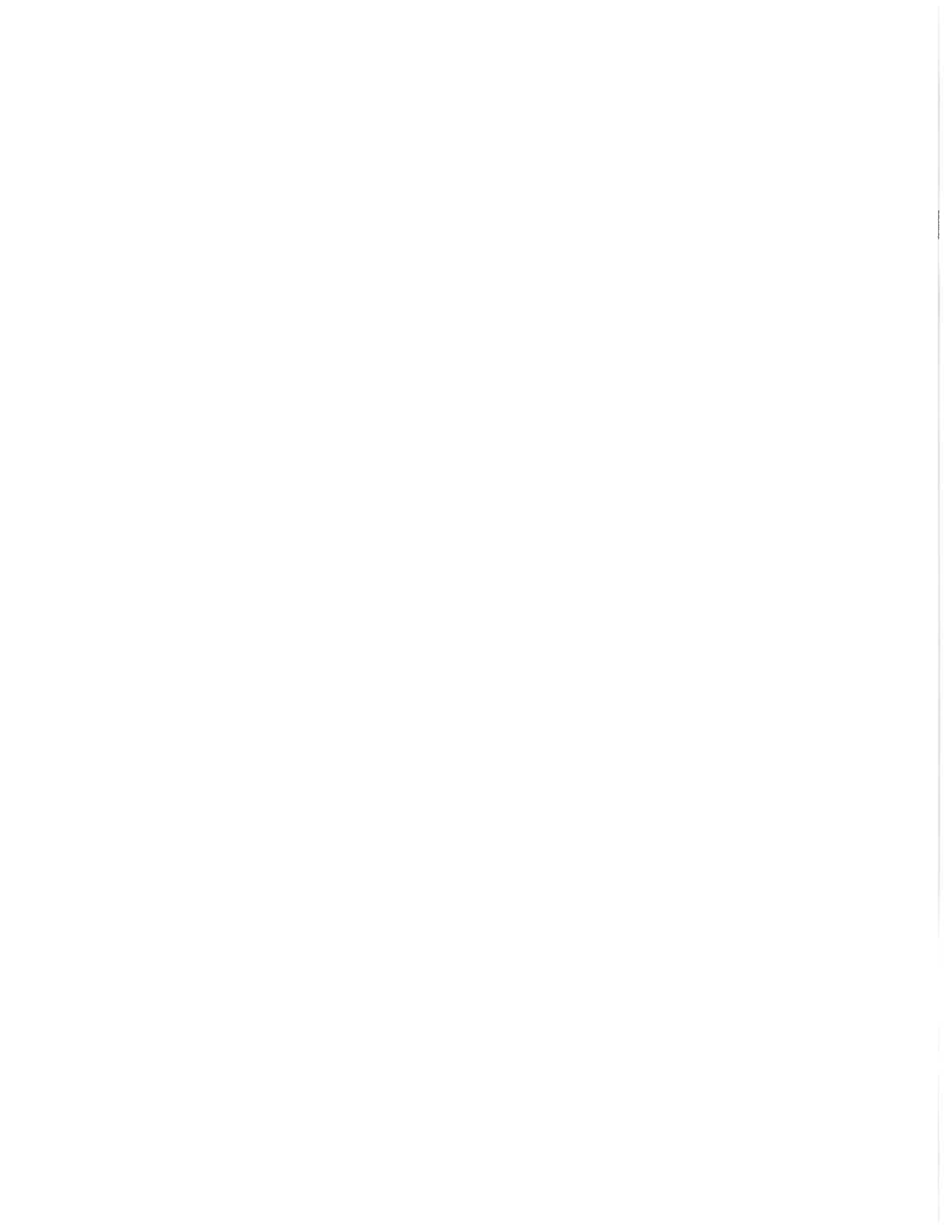



**Rio School District
Minutes
Regular Board Meeting
June 2, 2022
Rio School District
1800 Solar Drive
Oxnard, CA 93030
Closed Session: 5:00 p.m.
Open Session: 6:00 p.m.**

Members present

Edith Martinez-Cortes, Linda Armas, Kristine Anderson

1. Open Session 5:00 p.m.

1.1 Call to Order

President Anderson called the meeting to order at 5:02 p.m.

1.2 Pledge of Allegiance

President Anderson led the flag salute.

1.3 Roll Call

Trustee Armas called the roll.

President Anderson and Trustee Armas and Martinez-Cortes were present.

Trustee Torres was absent.

2. Approval of the Agenda

2.1 Agenda Correction, Additions, Modifications

President Anderson moved item 11.9 Approval of Resolution 21/22-22 to Improve Compensation for Certain Categories of Employees after July 1, 2022 to Discussion/Action.

2.2 Approval of the Agenda

Staff recommends approval as amended.

Motion by Kristine Anderson, second by Linda Armas.

Final Resolution: Motion Carries

Yes: Edith Martinez-Cortes, Linda Armas, Kristine Anderson

3. Public Comment-Closed Session

3.1 Public Comment (Closed Session) The public may address the Board concerning items that are scheduled for discussion during the closed session only. These presentations are limited to three minutes each, or a total of fifteen minutes in all.

Public comments on closed session were heard from Mary Walzer, Nicole Martin, Ana Hernandez, Hilda Lopez, and Sandra Estrada.

President Anderson adjourned the meeting into closed session at 5:22 p.m.

4. Closed Session

4.1 Conference Legal Counsel Re Current Litigation: OAH Case No. 2022040609

4.2 Public Employee Discipline/Dismissal/Release [Government Code 54957]

4.3 Public Employee Performance Evaluation [Government Code 54957] Title: Staffing 2021/2022 and 2022/2023

4.4 Conference with Labor Negotiators [Government Code 54957.6] Agency designated representatives: RSD Negotiating Team; Employee Organization: California School Employee's Association and Rio Teachers' Association

5. Reconvene Open Session 6:00 p.m.

5.1 Report of Closed Session

President Anderson reconvened the meeting at 6:29 p.m.

The Governing Board by a vote of 3-0, approved the settlement agreement for OAH Case No. 2022040609.

The Governing Board by a vote of 3-0, approved the release of Classified Employee No. 3990.

6. Recognitions/Presentations

6.1 Rio School District Years of Service and Retirement Awards

Rebecca Rocha, Director of Human Resources, began the Years of Service Awards and Retiree recognitions.

7. Public Hearing

7.1 Public Hearing and Notice of Intent to Adopt a Preliminary Environmental Assessment Equivalent for the Rio Del Valle Middle School Existing Campus Expansion Master Plan, South Parcel, Ventura County, California

President Anderson opened the public hearing at 6:48 p.m. There were no public comments.

Randy Westhaus, TetraTech, presented a PowerPoint slide show regarding the preliminary environmental assessment for Rio del Valle.

President Anderson closed the public hearing at 6:57 p.m.

7.2 Public Hearing for the District Sunshine Proposal to RTA

President Anderson opened the hearing at 6:57 p.m. As there were no comments, President Anderson closed the hearing at 6:57 p.m.

7.3 Public Hearing for the RTA Sunshine Proposal to the District
President Anderson opened the hearing at 6:57 p.m. As there were no public comments, President Anderson closed the hearing at 6:58 p.m.

7.4 Public Hearing of Local Control Accountability Plan (LCAP)
President Anderson opened the hearing at 6:58 p.m. As there were no public comments, President Anderson closed the hearing at 6:58 p.m.

7.5 Public Hearing for the 2022/2023 Budget Report
President Anderson opened the hearing at 6:58 p.m. As there were no public comments, President Anderson closed the hearing at 6:58 p.m.

8. Communications

8.1 Acknowledgement of Correspondence to the Board
Trustee Armas stated that she and the Governing Board received various emails.

8.2 Board Member Reports
Board member reports were heard from President Anderson.

8.3 Organizational Reports-RTA/CSEA/Other
Organizational reports were heard from Brandon Lewis, CSEA.

8.4 Superintendent Report
Superintendent Puglisi reported on Safety Planning.

The district did an additional revision of the site plans. We also sent out a survey to all parents and staff asking how they felt about the safety of the sites.

Superintendent Puglisi shared some of the results of the surveys.

8.5 Public Comment-Board meetings are meetings of the Governing Board held in public and will be held in a civil, orderly and respectful manner. Persons wishing to address the Board must fill out a speaker card. Cards are available at the meeting and on the District website. Cards must be submitted to the Secretary or Clerk of the Board. A member of the public may address the Governing Board on any item(s) on the agenda or non-agenda items. Each person speaking may not exceed a total of three minutes on each item. The speaker may choose to speak during public comment or at the time of the agenda item prior to board consideration. These presentations are limited to three minutes or a total of twenty minutes
Public comments were heard from Hannah Murphy and Anti Eidolon.

9. Information

Information: 9.1 Educational Services Report
Veronica Rauschenberger, Director of School and Systems Improvement, presented a CAASPP update.

9.2 Human Resources Updates
Rebecca Rocha, Director of Human Resources, provided information regarding COVID and enrollment.

10. Discussion/Action

10.1 Approval of Resolution 21/22-25 of the Board of Trustees of the Rio School District, Acting as the Legislative Body of Community Facilities District No. 1 of the Rio Unified School District, Authorizing the Levy of Special Taxes in Community Facilities District No. 1 of the Rio Unified School District for Fiscal Year 2022-2023

It is recommended that the Board of Trustees adopt Resolution No. 21/22-25, "Resolution of the Board of Trustees of the Rio Unified School District, Acting as the Legislative Body of Community Facilities District No. 1 of the Rio School District, Authorizing the Levy of Special Taxes in Community Facilities District No. 1 of the Rio Unified School District for Fiscal Year 2022-2023." Amended to remove the word "Unified" from the item.

Motion by Linda Armas, second by Kristine Anderson.

Final Resolution: Motion Carries

Yes: Edith Martinez-Cortes, Linda Armas, Kristine Anderson

10.2 Approval of Survey Consulting Agreement from Isom Advisors, a Division of Urban Futures, Inc.

Staff recommends the Approval of Isom Advisors survey consulting agreement.

Motion by Linda Armas, second by Edith Martinez-Cortes.

Final Resolution: Motion Carries

Yes: Edith Martinez-Cortes, Linda Armas, Kristine Anderson

10.3 Approval of Rio Teachers' Association Sunshine Proposal to the Rio School District
District Staff recommend approval of the Rio Teachers' Association Sunshine Proposal to the Rio School District.

Motion by Linda Armas, second by Kristine Anderson.

Final Resolution: Motion Carries

Yes: Edith Martinez-Cortes, Linda Armas, Kristine Anderson

10.4 Approval of Rio School District Sunshine Proposal to Rio Teachers' Association
Staff recommends approval of the Rio School District Sunshine Proposal to Rio Teachers' Association.

Motion by Kristine Anderson, second by Linda Armas.

Final Resolution: Motion Carries

Yes: Edith Martinez-Cortes, Linda Armas, Kristine Anderson

10.5 Approval of MOU with Rio Teachers' Association regarding Transitional Kindergarten Expansion

Staff recommends approval of the MOU with the Rio Teachers' Association-Transitional Kindergarten Expansion.

Motion by Linda Armas, second by Kristine Anderson.

Final Resolution: Motion Carries

Yes: Edith Martinez-Cortes, Linda Armas, Kristine Anderson

10.6 Approval of MOU with Rio Teachers' Association Regarding Sub Pay for the 2022-2023 School Year

District staff recommends approval of the MOU with the Rio Teachers' Association Regarding Sub Pay for the 2022-2023 school year.

Motion by Linda Armas, second by Kristine Anderson.

Final Resolution: Motion Carries

Yes: Edith Martinez-Cortes, Linda Armas, Kristine Anderson

10.7 Approval of the 2022-2023 School Bell Schedules

District staff recommends approval of the 2022-2023 bell schedules.

Motion by Linda Armas, second by Kristine Anderson.

Final Resolution: Motion Carries

Yes: Edith Martinez-Cortes, Linda Armas, Kristine Anderson

11. Consent

11.1 Approval of the Consent Agenda

Staff recommends approval as amended.

Motion by Linda Armas, second by Kristine Anderson.

Final Resolution: Motion Carries

Yes: Edith Martinez-Cortes, Linda Armas, Kristine Anderson

11.2 Approval of the Minutes of the Regular Board Meeting of May 18, 2022

Staff recommends approval as amended.

11.3 Approval of the Minutes of the Special Board Meeting of June 1, 2022

11.4 Approval of June Personnel Report

11.5 Ratification of the Commercial Warrant for May 6, 2022 through June 8, 2022.

11.6 Approval of Estimated Fees for Legal Services Provided by Myers, Widders, Gibson, Jones, for Various Construction and Developer related projects for the 2022/2023 fiscal year.

11.7 Blanket Resolution No. 21/22-23 Regarding Appropriation Transfers for 2022/2023 fiscal year

11.8 Approval of Resolution 21/22-24 Regarding Temporary Loans Between District Funds for Fiscal Year 2022-2023

11.9 Approval of Resolution No. 21/22-22 to Improve Compensation for Certain Categories of Employees After July 1, 2022

It is recommended that the Board Approve Resolution No. 21/22-22 for Authority to Improve Compensation for Certain Categories of Employees after July 1, 2022.

Motion by Linda Armas, second by Kristine Anderson.

Final Resolution: Motion Carries

Yes: Edith Martinez-Cortes, Linda Armas, Kristine Anderson

11.10 Approval of the Agreement for Bond and Disclosure Counsel Services between RSD and Parker and Covert for the 2022/2023 fiscal year.

11.11 Approval of Vendor List of Open Purchase Orders for Maintenance, Operations and Transportation for 2022/2023

11.12 Approval of Agreement from the Ventura County Sheriff's Department for a School Resource Officer at Rio Del Valle for 2022/2023.

11.13 Approval of the Education Protection Account Spending (EPA) Plan for 2022/2023

11.14 Approval of Contracts with VCOE for ESCAPE Financial and Payroll/Personnel Software System for 2022/2023.

11.15 Approval to declare and sell obsolete E-waste Devices

11.16 Approval of MOU with Children's Resource Programs

11.17 Approval of the Memorandum of Understanding-Interdistrict Transfers

11.18 Approval of Food Service Vending Contract for 2022/2023 with Child Development Resources (CDR)

11.19 Approval of the Food Service Vending Contract with The Catalyst Family Inc. (formally known as Continuing Development Incorporated (CDI) for the 2022/2023 school year.

11.20 Approval of Food Service Vending Contract with the Boys and Girls Club of Greater Oxnard and Port Hueneme (Nyeland Center) for the 22/23 school year.

11.21 Approval of Change Order #1 with Smith M.E.P. for Project 21-15L, Rio Vista Gym HVAC and Electrical

11.22 Approval of Notice to Award the Lowest Responsive Bidder for the Rio Plaza Shade Structure Project, #22-06L, to EJS Construction

12. Organizational Business

12.1 Future Items for Discussion

12.2 Future Meeting Dates: June 29, 2022

13. Adjournment

13.1 Adjournment

President Anderson adjourned the meeting at 7:41 p.m.

Approved on this 29th day of June, 2022.

John Puglisi, Ph.D., Secretary Date

Edith Martinez-Cortes, Clerk of the Board Date

**Agenda Item Details**

Meeting	Jun 29, 2022 - RSD Regular Board Meeting
Category	9. Consent
Subject	9.3 Approval of the Personnel Report
Access	Public
Type	Action (Consent)
Recommended Action	Staff recommends approval of the Personnel Report

Public Content

Speaker: Rebecca Rocha, Director of Human Resources

Rationale:

Staff presents the staffing report as of June 29, 2022.

Administrative Content**Executive Content**

Our adopted rules of Parliamentary Procedure, Robert's Rules, provide for a consent agenda listing several items for approval of the Board by a single motion. Most of the items listed under the consent agenda have gone through Board subcommittee review and recommendation. Documentation concerning these items has been provided to all Board members and the public in advance to assure an extensive and thorough review. Items may be removed from the consent agenda at the request of any board member.

RIO SCHOOL DISTRICT
June 29, 2022

Certificated Personnel Report

Certificated Summer Employment Science Academy:

Huynh, Kathy, Teacher, 6 hours
Sanchez, Luke, Teacher, 6 hours

Certificated Summer Employment Connect, Learn and Grow:

Grandbois, Marina, Teacher, 5 hours
Serrano, Jeanett, Teacher, 5 hours
Romero, Marc, Teacher, 5 hours
Contreras, Andrea, Teacher, 5 hours
Orosco, Bertha, Teacher, 5 hours
Cruz, Stephanie, Teacher, 5 hours
Quiatchon, Juanpaulo, Teacher, 5 hours
Billet, Katherine, 5 hours
Reed, Dorene, Teacher, 5 hours
Maile, Adrienne, Teacher, 5 hours
Decandia, Stacey, Teacher, 5 hours
Guevara, Christopher, Teacher, 5 hours
Samudio, Delzy, Teacher, 5 hours
Lusparyan, Ani, Teacher, 5 hours

Certificated Summer Employment Art Academy:

Duteil, Arlene, Teacher, 5 hours
Vargas, Alejandra, Teacher, 5 hours

Certificated Summer Employment Music:

Raymond, Kirk, Teacher, 7.5 hours
Regalado, TeriLynn, Teacher, 7.5 hours

Certificated Summer Employment Technology Genius:

Manzano, Brianna, Teacher, 6.5 hours

Classified Personnel Report

Classified Involuntary Transfer:

Cardenas, Yunuen, from After School Program Site Coordinator, (5.5) hours, Rio del Sol to After School Program Site Coordinator, (5.5) hours, Rio Lindo, effective 8/23/22
Paz, Sammy, from After School Program Site Coordinator, (5.5) hours, Rio Lindo to After School Program Site Coordinator, (5.5) hours, Rio del Sol, effective 8/23/22

Classified Summer Employment - 2022

Art Academy (July 5 - August 11):

Baez, Josephine, Instructional Assistant /Special Education, (4.5) hours
Contreras, Erika, Instructional Assistant /Special Education, (4.5) hours
Duckett, Theodore, Instructional Assistant /Special Education, (4.5) hours
Murphy, Hannah, Instructional Assistant /Special Education, (4.5) hours
Zarate, Israel, Instructional Assistant /Special Education, (4.5) hours

Campus Supervision Assistants (June 27, - August 11):

Agraz, Juana, (5.5) hours
Camarena, Maria, (5) hours
Campbell, Diane, (4) hours
Anguiano, Yolanda, (5.75) hours
Lopez, Leticia, (5.5) hours
Maddox, Roi, (5) hours
Munoz, Brenda, (5.75) hours
Ramos, Teresa, (5.75) hours
Ramriez, Manuel, (5.75) hours
Sanchez, Bellinda, (3) hours
Zavala, Imelda, (5) hours

Clerical Assignments (June 27, - August 11):

Agraz, Mary, Clerk Typist II, (4.5) hours
Almaguer, Alexis, Clerk Typist II, (5) hours
Casarez, Frances, Clerk Typist II, (5) hours
Chavez, Angela, Clerk Typist II, (5) hours
Garcia, Elizabeth, Clerk Typist II, (4) hours
Lopez, Iliana, Clerk Typist II, (5) hours
Mayen, Melissa, Clerk Typist II, (5) hours
Mejia, Andrea, Clerk Typist II, (6) hours
Quirino, Christian, Clerk Typist II, (5) hours
Torres, Raelene, Clerk Typist II, (5) hours

Connect Learn & Grow (July 6, - August 5):

Alatorre, Tanya, Instructional Assistant /Special Education, (5) hours
Andrade, Concepcion, Instructional Assistant /Special Education, (5) hours
Gomez, Rogelio, Instructional Assistant /Special Education, (5) hours
Gonzalez, Melissa, Instructional Assistant /Special Education, (5) hours
Mendez, Brisa, Instructional Assistant /Special Education, (5) hours
Rabelo, Lily, Instructional Assistant /Special Education, (5) hours
Gonzalez, Christopher, Instructional Assistant /Special Education, (5) hours
Torres Camarillo, Laura, Clerical (5) hours

Explore Summer Programs (July 6, - August 5):

Bybee, Brittany, After School Program Site Coordinator, (8) hours
Garcia, Ruth, After School Program Site Coordinator, (5.5) hours
Sajid, Ambreen, After School Program Site Coordinator, (5.5) hours

Food Service (June 21 - August 22):

Alfaro, Maria, Food Service Manager, (5) hours

Kinder Jump Start Program:

Gonzalez, Valeria, Instructional Assistant /Special Education, (3) hours
Torres, Maria, Instructional Assistant /Special Education, (3) hours

Special Education Extended Year Program (June 27 - July 29):

Borja, Jessica, Instructional Assistant /Special Education, (4.5) hours
Magana, Alice, Instructional Assistant /Special Education, (4.5) hours

Science Academy (June 27 - July 15):

Cabral, Serrina, (5.5) hours
Martinez, Jorge, Instructional Assistant /Special Education (5.5) hours
Martinez, Martha, Instructional Assistant /Special Education (5.5) hours

Morales, Giovanni, Instructional Assistant /Special Education (5.5) hours

Rodriguez, Evelyn, Instructional Assistant /Special Education (5.5) hours

Samimi, Jaleh, Instructional Assistant /Special Education(5.5) hours

Sports Academy (July 6 - August 5):

Chavez, Maria, Instructional Assistant /Special Education, (3) hours

Technology Genius Academy(July 18 - August 5):

Chavarria, Jennifer, Instructional Assistant /Special Education(5.5) hours

Hinkle, John, Instructional Assistant /Special Education(5.5) hours

Segovia, Mckayla, Instructional Assistant /Special Education(5.5) hours

9.4



Agenda Item Details

Meeting	Jun 29, 2022 - RSD Regular Board Meeting
Category	9. Consent
Subject	9.4 Contract Renewal with Diane DeLaurentis to Provide Drama Instruction FY 2022/2033
Access	Public
Type	Action (Consent)
Fiscal Impact	Yes
Dollar Amount	47,300.00
Budgeted	Yes
Budget Source	LCFF
Recommended Action	Staff recommends approval of the contract renewal with Diane DeLaurentis FY 22/23
Goals	<p>Goal 3-Create welcoming and safe environments where students attend and are connected to their school</p> <p>Goal 1-Improved student achievement at every school and every grade in all content areas</p>

Public Content

Speaker: Superintendent Puglisi

Rationale:

Ms. DeLaurentis will continue to provide drama instruction and provide summer camps, the 5C's Play and the RSD Musical.

DeLaurentis202223.pdf (115 KB)

Administrative Content

Executive Content

Our adopted rules of Parliamentary Procedure, Robert's Rules, provide for a consent agenda listing several items for approval of the Board by a single motion. Most of the items listed under the consent agenda have gone through Board subcommittee review and recommendation. Documentation concerning these items has been provided to all Board

members and the public in advance to assure an extensive and thorough review. Items may be removed from the consent agenda at the request of any board member.

6/15/2022

Dear Board Members,

Attached is my 2022-2023 Performing Arts contract proposal for the Rio School District. I am offering the Rio School District: weekly Elementary workshops at 5 different Elementary Schools, a Middle School Drama Elective(s), producing, directing and teaching choreography for a District Musical, and directing an Artistic project with HHM. My instruction in Performing Arts improves students' self-confidence, creativity, critical thinking, communication, collaboration, artistic expression and is a safe haven for struggling students. I hope to be given the opportunity to work with Rio students again. It is an honor.

Sincerely,

Diane DeLaurentis
Artist in Residence, Drama
Most Excellent Enterprises, inc.

Diane DeLaurentis - Most Excellent Enterprises, Inc.
PERFORMING ARTS CONTRACT PROPOSAL
2022-2023

To: Rio District School Board

From: Most Excellent Enterprises, Inc.
Diane DeLaurentis, *Artist in Residence, Drama*

Re: Drama instruction for Rio School District

Date of Proposed Service: August 18, 2022 - June 15, 2023

1. WEEKLY CLASSROOM DRAMA WORKSHOPS (K-5th)

October 2022 to June 2023

DESCRIPTION: Instructor teaches dynamic and innovative half-hour workshops introducing creative drama exercises and games to elementary students. Students will demonstrate their performing skills in a variety of ways: improvisation, skits, pantomime exercises. Students will learn presentation skills such as blocking, eye-contact and voice techniques, play games that explore imagination, creativity and self-expression, and also demonstrate problem solving, collaboration, listening and responding skills. Individual attention is given to each student. ALL RIO DISTRICT TEACHERS can sign up on Google Docs and class meetings will be held on Google Meet at weekly scheduled time.

Students: Based on who signs up over 1000 students a week.
 Where: RDM/RL/RN/RDS/RR
 Days: M-F
 Time: 8:30am-2:30pm

Fee: \$38,000

2. DRAMA ELECTIVES (RVMS/RDS/RDV)

August 18, 2022 – June 15, 2023

DESCRIPTION: Instructor will teach Middle School ELECTIVE classes hip-pocketing music class with Ms. Regalado (RVMS), video class with Mr. Espinoza (RDS) and at RDV (with TBA.) This class is ideal for 7th or 8th grade students who want to learn about acting, increase their self-confidence, explore their imagination, express emotion

and get over stage fright. No homework, but class effort and participation is required. Students will demonstrate acting, improvisation and presentation skills throughout the year doing scenes, monologues, plays in class, on film and on stage. Topics include the history of world theatre, theater vocabulary, pantomime, scenes, monologues, play analysis, speech, voice, blocking, auditioning, and creating a short film.

Students: 7th & 8th grade
 Where: RVMS/RDS/RDV
 Days: M-F
 Time: 10 hours/week (includes prep)

\$18,000 per Middle School

3. DISTRICT MUSICAL

October to May

DESCRIPTION: Directing a full stage production of an age-appropriate musical for the Rio District. Duties include selecting musical, holding auditions for students' 5th to 8th grade, casting 2 casts, managing bi-weekly rehearsals, teaching choreography, working with the art dept, selecting wardrobe, selecting props, working with special effects dept, giving lighting cues to tech director, running Tech Rehearsal, running Dress Rehearsal, 4 performances, holding an award ceremony at the end of the year for students and all the while incorporates the 5 C's into the program.

Students: 30- 60 students
 Where: RVMS, room 13
 Days: Thursdays and Tuesdays
 Time: 3:00pm-6:00pm

Fee: \$8400

4. DISTRICT ARTISTIC PERFORMANCE

January to March

DESCRIPTION: Instructor works with HHM creating a story and directing a 20 – 45 min. dance performance created specifically for the Rio School District. Elementary, Middle School and Oxnard High School students will be cast in roles. Play will be performed on stage.

Students: 50
 Where: RVMS Cafeteria
 Days: Mondays
 Time: 3:30-6:30

Fee: \$1200



TOTAL FEES:

Drama (No Electives)

\$47,300

9.5





Agenda Item Details

Meeting	Jun 29, 2022 - RSD Regular Board Meeting
Category	9. Consent
Subject	9.5 Approval of Contract Renewal with Steve Sunnarborg FY 2022/2023
Access	Public
Type	Action (Consent)
Fiscal Impact	Yes
Dollar Amount	45,000.00
Budgeted	Yes
Recommended Action	Staff recommends the contract renewal with Steve Sonnarberg FY 22/23
Goals	<p>Goal 4-Prepare students to be college and career ready through technology and innovation that facilitates collaboration, creativity, critical thinking and communication.</p> <p>Goal 1-Improved student achievement at every school and every grade in all content areas</p>

Public Content

Speaker: John Puglisi, Ph.D., Superintendent

Rationale:

Mr. Sonnarberg will continue to provide services to the students providing music instruction as Artist in residence.

[Sunnorborg202223.pdf \(184 KB\)](#)

Administrative Content

Executive Content

Our adopted rules of Parliamentary Procedure, Robert's Rules, provide for a consent agenda listing several items for approval of the Board by a single motion. Most of the items listed under the consent agenda have gone through Board subcommittee review and recommendation. Documentation concerning these items has been provided to all Board members and the public in advance to assure an extensive and thorough review. Items may be removed from the consent agenda at the request of any board member.



**SCHOOL
DISTRICT**

EDUCATING LEARNERS FOR THE 21ST CENTURY

Superintendent John D. English, Ph.D.

SHORT FORM SERVICES AGREEMENT

This Agreement is intended to be used for low cost, low risk, short-term services.

This Services Agreement (the "Agreement") is made and entered into this 30th day of June, 2022

Rio School District (hereinafter referred to as "District") and Steven Sunnarborg (hereinafter referred to as "Provider.")

Steven Sunnarborg Musical Services

Provider

Telephone Number

Street Address

Fax Number

City, State, Zip code

E-mail Address

Tax Identification or Social Security Number

Business License Number (if applicable)

SERVICES

Music Instruction, Performance, Technology and More!
Description of Services

Design, Coordinate and Application of Music Lessons group and private. Create Technological Methods of student immersion and participation. Support of team members musical needs. Adaptability of methods and game plans to suit the needs of RSD.

Date(s) of Service 6/30/2022-6/30/2023 Hour(s) of Service Varies Location various in RSD

FEES

Compensation for Services **\$ 50.00 per hour**

Other Ancillary Cost, as applicable \$ supplies with receipt

Total not to Exceed \$ **\$45,000**

- W-9 received

PAYMENT. District will pay Provider after receipt of an invoice, net 30 days.

CONDITIONS. Provider will have no obligation to provide services until the District returns a signed copy of this Agreement.

NATURE OF RELATIONSHIP. The parties agree the relationship created by this Agreement is that of an independent contractor.

AUTHORITY. Provider represents and warrants that Provider has all requisite power and authority to conduct its business and to execute, deliver, and perform this Agreement.

BINDING EFFECT. This Agreement shall insure to the benefit and shall be binding upon all of the parties to this Agreement, and their respective successors in interest or assigns.

TERMINATION OR AMENDMENT. This Agreement may be terminated or amended in writing at any time by mutual written consent of all of the parties to this Agreement, and may be terminated by either party for any reason by giving the other party 30 days advance written notice.

NON-DISCRIMINATION AND EQUAL EMPLOYMENT OPPORTUNITY. Provider represents and agrees that it does not and shall not discriminate against any employee or applicant for employment because of race, religion, color, sex, or national origin.

GOVERNING LAW AND VENUES. This Agreement shall be interpreted in accordance with the laws of the State of California. If any action is brought to interpret or enforce any term of this Agreement, the action shall be brought in state or federal court situated in the County of Ventura, State of California.

ARBITRATION. Any dispute arising under this Agreement, including, without limitation, all disputes relating in any manner to the performance or enforcement of this Agreement shall be resolved by binding arbitration in Ventura County pursuant to the rules of the American Arbitration Association.

ATTORNEYS FEES. In the event of any action or proceeding to interpret or enforce the terms of this Agreement, the prevailing party, as determined by the court or arbitrator, shall be entitled to recover its reasonable attorneys fees and costs incurred in connection with such actions or proceeding.

INDEMNIFICATION. Provider agrees to defend, indemnify, and hold harmless District, its officers, agents, employees, and/or volunteers from any and all claims, demands, losses, damages and expenses, including legal fees and costs, or other obligations or claims arising out of any liability or damage to person or property, or any other loss, sustained or claimed to have been sustained arising out of activities of the Provider or those of any of its officers, agents, employees, or subcontractors of Provider, whether such act or omission is authorized by this Agreement or not. Provider shall also pay for any and all damage to the Real and Personal Property of the District, or loss or theft of such Property, done or caused by such persons. District assumes no responsibility whatsoever for any property placed on District premises by Provider, Provider's agents, employees or subcontractors. Provider further hereby waives any and all rights of subrogation that it may have against the District. The provisions of this Agreement do not apply to any damage or losses caused solely by the negligence of the District or any of its officers, agents, employees, and/or volunteers.

INSURANCE. Provider, at its own cost and expense, shall procure and maintain during the term of this Agreement, policies of insurance for the following types of coverage:

- **Workers' Compensation Insurance.** Provider shall procure and maintain, during the term of this Agreement, Workers' Compensation Insurance, as required by California law, on all of its employees engaged in work related to the performance of this Agreement. In the case of any activities which are hired or subcontracted, Provider shall require all vendors and subcontractors to provide Workers' Compensation Insurance for all of the vendor's and/or subcontractor's employees to be engaged in such activities unless such employees are covered by the protection afforded by the Provider's Workers' Compensation Insurance.
- **Commercial General Liability Insurance.** Provider shall procure and maintain, during the term of this Agreement, not less than the following General Liability Insurance coverage in the amounts of \$1,000,000 per occurrence and \$2,000,000 aggregate.

Commercial General Liability insurance shall include products/completed operations, broad form property damage, and personal and advertising injury coverage.

Any and all vendors and subcontractors hired by Provider in connection with the activities described in this Agreement shall maintain such insurance unless the Provider's insurance covers the subcontractor and its employees.

- **Automobile Liability.** If vehicles will be driven on district property, Provider shall procure and maintain, during the full term of this Agreement following Automobile Liability Insurance with the following minimum coverage limits:

Personal vehicles: \$500,000.00 combined single limit or
 \$100,000.00 per person / \$300,000.00 per accident
Commercial vehicles: \$1,000,000.00 combined single limit

9.6



Agenda Item Details

Meeting	Jun 29, 2022 - RSD Regular Board Meeting
Category	9. Consent
Subject	9.6 Approval of Service Agreement Renewal with Nee Quaison-Sackey to Provide Music Instruction FY 2022/23
Access	Public
Type	Action (Consent)
Fiscal Impact	Yes
Dollar Amount	45,000.00
Budgeted	Yes
Budget Source	LCFF
Recommended Action	Staff recommends approval for the Service Agreement with Nee Quaison-Sackey FY 2022/23
Goals	<p>Goal 4-Prepare students to be college and career ready through technology and innovation that facilitates collaboration, creativity, critical thinking and communication.</p> <p>Goal 1-Improved student achievement at every school and every grade in all content areas</p>

Public Content

Speaker: John Puglisi, Ph.D., Superintendent

Rationale:

Mr. Quaison-Sackey will provide music education classes to students in the RSD.

[Nee202223.pdf \(189 KB\)](#)

Administrative Content

Executive Content

Our adopted rules of Parliamentary Procedure, Robert's Rules, provide for a consent agenda listing several items for approval of the Board by a single motion. Most of the items listed under the consent agenda have gone through Board subcommittee review and recommendation. Documentation concerning these items has been provided to all Board

members and the public in advance to assure an extensive and thorough review. Items may be removed from the consent agenda at the request of any board member.

GOVERNING LAW AND VENUES. This Agreement shall be interpreted in accordance with the laws of the State of California. If any action is brought to interpret or enforce any term of this Agreement, the action shall be brought in state or federal court situated in the County of Ventura, State of California.

ARBITRATION. Any dispute arising under this Agreement, including, without limitation, all disputes relating in any manner to the performance or enforcement of this Agreement shall be resolved by binding arbitration in Ventura County pursuant to the rules of the American Arbitration Association.

ATTORNEYS FEES. In the event of any action or proceeding to interpret or enforce the terms of this Agreement, the prevailing party, as determined by the court or arbitrator, shall be entitled to recover its reasonable attorneys fees and costs incurred in connection with such actions or proceeding.

INDEMNIFICATION. Provider agrees to defend, indemnify, and hold harmless District, its officers, agents, employees, and/or volunteers from any and all claims, demands, losses, damages and expenses, including legal fees and costs, or other obligations or claims arising out of any liability or damage to person or property, or any other loss, sustained or claimed to have been sustained arising out of activities of the Provider or those of any of its officers, agents, employees, or subcontractors of Provider, whether such act or omission is authorized by this Agreement or not. Provider shall also pay for any and all damage to the Real and Personal Property of the District, or loss or theft of such Property, done or caused by such persons. District assumes no responsibility whatsoever for any property placed on District premises by Provider, Provider's agents, employees or subcontractors. Provider further hereby waives any and all rights of subrogation that it may have against the District. The provisions of this Agreement do not apply to any damage or losses caused solely by the negligence of the District or any of its officers, agents, employees, and/or volunteers.

INSURANCE. Provider, at its own cost and expense, shall procure and maintain during the term of this Agreement, policies of insurance for the following types of coverage:

- **Workers' Compensation Insurance.** Provider shall procure and maintain, during the term of this Agreement, Workers' Compensation Insurance, as required by California law, on all of its employees engaged in work related to the performance of this Agreement. In the case of any activities which are hired or subcontracted, Provider shall require all vendors and subcontractors to provide Workers' Compensation Insurance for all of the vendor's and/or subcontractor's employees to be engaged in such activities unless such employees are covered by the protection afforded by the Provider's Workers' Compensation Insurance.

- **Commercial General Liability Insurance.** Provider shall procure and maintain, during the term of this Agreement, not less than the following General Liability Insurance coverage in the amounts of \$1,000,000 per occurrence and \$2,000,000 aggregate.

Commercial General Liability insurance shall include products/completed operations, broad form property damage, and personal and advertising injury coverage.

Any and all vendors and subcontractors hired by Provider in connection with the activities described in this Agreement shall maintain such insurance unless the Provider's insurance covers the subcontractor and its employees.

- **Automobile Liability.** If vehicles will be driven on district property, Provider shall procure and maintain, during the full term of this Agreement following Automobile Liability Insurance with the following minimum coverage limits:

Personal vehicles: \$500,000.00 combined single limit or

\$100,000.00 per person / \$300,000.00 per accident

Commercial vehicles: \$1,000,000.00 combined single limit

- **Other Coverage as Dictated by the District.** Provider shall procure and maintain, during the term of this Agreement, Abuse and Molestation coverage in the amounts of \$1,000,000 per occurrence and \$2,000,000 aggregate.

Certificates of Insurance. Provider and any and all vendors and subcontractors working for Provider shall provide certificates of insurance to the District as evidence of the insurance coverage required herein, not less than 15 days prior to commencing the proposed activity, and at any other time upon the request of the District. Certificates of such insurance shall be filed with the District on or before commencement of the services under this Agreement.

Provider's and any and all Provider subcontractor's Commercial General Liability insurance and Abuse and Molestation coverage shall name the District, its employees, and school board members as additional insureds.

Insurance written on a "claims made" basis is to be renewed by the Provider and all Provider subcontractors for a period of three (3) years following termination of this Agreement. Such insurance must have the same coverage and limits as the policy that was in effect during the term of this agreement, and will cover the Provider for all claims made.

Failure to Procure Insurance. Failure on the part of Provider, or any of its subcontractors, to procure or maintain required insurance shall constitute a material breach of contract under which the District may immediately terminate this Agreement.

ACKNOWLEDGEMENT AND AGREEMENT

I have read this agreement and agree to its terms

Provider signature

4th June 2022
Date

SITE AGREEMENT

Site Administrator

Signature

Date

DISTRICT APPROVAL

District Administrator

Signature

Date

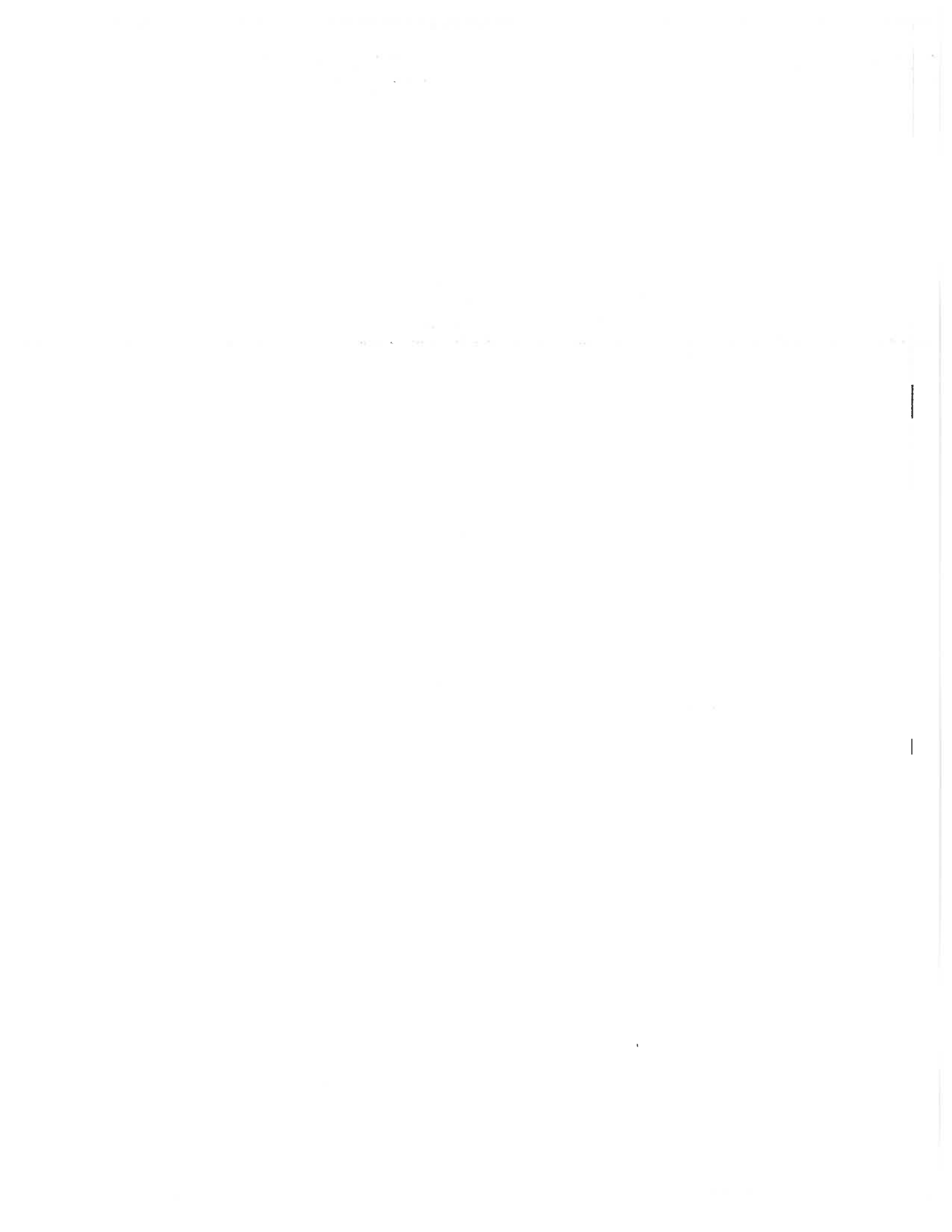

9.7



Agenda Item Details

Meeting	Jun 29, 2022 - RSD Regular Board Meeting
Category	9. Consent
Subject	9.7 Approval of Contract Renewal with Lawrence Interactive Media FY 2022/2023
Access	Public
Type	Action (Consent)
Dollar Amount	71,400.00
Budgeted	Yes
Budget Source	General Fund
Recommended Action	Staff recommends approval of the Contract Renewal with Lawrence Media FY 2022/2023
Goals	Goal 4-Prepare students to be college and career ready through technology and innovation that facilitates collaboration, creativity, critical thinking and communication.

Public Content

Speaker: John Puglisi, Ph.D., Superintendent

Rationale: Lawrence Interactive Media will provide updates, cleanup, improve navigation and add content to all site and district office websites.

Rio - Web Maintenance & Hosting Contract - 2022-23 - Wolf Media.pdf (26 KB)

Rio - Web Development Contract - 2022-23 AS NEEDED - Wolf Media.pdf (24 KB)

Administrative Content

Executive Content

Our adopted rules of Parliamentary Procedure, Robert's Rules, provide for a consent agenda listing several items for approval of the Board by a single motion. Most of the items listed under the consent agenda have gone through Board subcommittee review and recommendation. Documentation concerning these items has been provided to all Board members and the public in advance to assure an extensive and thorough review. Items may be removed from the consent agenda at the request of any board member.



Wolf Media
 5690 Willow View Drive
 Camarillo, CA 93012
 +1 8057447177
 larry@wolfmedia.us
 https://wolfmedia.us

Estimate 00631



ADDRESS

Dr. John Puglisi / Sonia Cervantez
 Rio School District
 1800 Solar Drive
 Oxnard, CA 93030

DATE
 06/03/2022

TOTAL
 \$35,700.00

CATEGORY	ACTIVITY	QTY	RATE	TOTAL
Management	<p>MONTHLY WEBSITE PROACTIVE MANAGEMENT, MAINTENANCE, SECURITY and UPDATES CONTRACT (July 1, 2022 - Jun 30, 2023 - Invoiced Quarterly) Monthly agreement to maintain and monitor all 11 websites* of the Rio School District, providing monthly services including the following:</p> <ul style="list-style-type: none"> • Maintenance & Compatibility - Fix issues that come up with compatibility, problems with menus, widgets, pages, and posts. • Structural Updates - Weekly updates to WordPress software, Custom Theme, PHP, Server Software (if applicable) and all plugins • Security - Daily scans, monitoring, and check of security issues, vulnerabilities, breaches, and fix/patches. • Speed Checks – Daily scans, optimizations and speed checks to keep sites loading consistently and fast. • Backups - Daily, Weekly, Monthly server level, cloud backup services. • Reporting - Monthly consolidated reporting on backups, updates, security scans and performance scans. • Feedback & Guidance - Provide regular feedback and suggestions for changes, upgrades and improvements to the sites. <p>*Rio District, Rio del Mar, Rio del Norte, Rio del Sol, Rio del Valle, Rio Lindo, Rio Plaza, Rio Real, Rio Rosales, Rio Vista, Rio Independent Study</p> <p>Payment Schedule</p> <ul style="list-style-type: none"> • January - March (billed Jan. 1) • April - June (billed Apr 1) • July - September (billed July 1) • October - December ((billed Oct. 1). 	12	2,950.00	35,400.00

Thank you for the opportunity to serve you in helping to increase sales, grow marketshare, and expand revenue streams. Once you are ready to move forward, we just need a signed estimate and 30% down to get started! Let us know if you have any questions. (Proverbs 28:20)

CATEGORY	ACTIVITY	QTY	RATE	TOTAL
Hosting	<p>MONTHLY HIGH PERFORMANCE CLOUD HOSTING SERVICES (July 1, 2022 - Jun 30, 2023 - Invoiced Quarterly)</p> <p>Monthly Custom Website Hosting Package for all 11 Websites:</p> <ul style="list-style-type: none"> - WordPress Optimized Cloud Servers - Updated PHP 7.4+ - Solid State Drives - Custom Containerized Shared Hosting Environment - Included SSL Certificates (HTTPS) - \$70 savings per site/yr - Content Delivery Network (CDN) - NGINX High Speed Server (4x faster than Apache Servers) - 24 Hour Uptime Analysis - Daily Backups - Static Page 200x faster than GoDaddy's average load speed <p>Payment Schedule</p> <ul style="list-style-type: none"> • January - March (billed Jan. 1) • April - June (billed Apr 1) • July - September (billed July 1) • October - December ((billed Oct. 1). 	12	550.00	6,600.00

This is the annual contract for WEBSITE MANAGEMENT, MAINTENANCE, SECURITY, BACKUP and MONITORING (July 1, 2022 - June 30, 2023).

SUBTOTAL 42,000.00
DISCOUNT 15% -6,300.00

This CONTRACT also include HIGH PERFORMANCE CLOUD HOSTING SERVICES.

TOTAL \$35,700.00

Pricing includes a 15% education discount.

THANK YOU.

Accepted By

Accepted Date

Thank you for the opportunity to serve you in helping to increase sales, grow marketshare, and expand revenue streams. Once you are ready to move forward, we just need a signed estimate and 30% down to get started! Let us know if you have any questions. (Proverbs 28:20)

Wolf Media
 5690 Willow View Drive
 Camarillo, CA 93012
 +1 8057447177
 larry@wolfmedia.us
 https://wolfmedia.us

Estimate 00632



ADDRESS

Dr. John Puglisi / Sonia Cervantez
 Rio School District
 1800 Solar Drive
 Oxnard, CA 93030

DATE
 06/03/2022

TOTAL
 \$36,000.00

CATEGORY	ACTIVITY	QTY	RATE	TOTAL
Development	WEBSITE DEVELOPMENT CONTRACT (As Needed - NOT TO EXCEED) (July 1, 2022-June 30, 2023) Monthly agreement for website development, changes and new integrations for Rio School District websites, as needed. This could includes projects like: <ul style="list-style-type: none"> • Major Changes to Pages, Posts or site structures • Custom Integrations for Campuses - Working with schools to create better tools and integrations for teachers, parents and students • Training & Support - Helping Principals, schools, and district staff with updating and revising website content, as need. • Content Support - Help Carlo, as needed, in updating content, pages and posts. • Special Projects - New development and integrations for custom applications, learning management systems, and new programs and services for the district. 	12	3,000.00	36,000.00

(Development work is billed at \$110/hr, minus a 15% discount)

WEB DEVELOPMENT CONTRACT (July 1, 2022 - June 30, 2023) - As needed,
 NOT TO EXCEED. (Development work is billed at \$110/hr, minus a 15%
 discount)

TOTAL

\$36,000.00

THANK YOU.

Accepted By

Accepted Date

Thank you for the opportunity to serve you in helping to increase sales, grow marketshare, and expand revenue streams. Once you are ready to move forward, we just need a signed estimate and 30% down to get started! Let us know if you have any questions. (Proverbs 28:20)

9.8



Agenda Item Details

Meeting	Jun 29, 2022 - RSD Regular Board Meeting
Category	9. Consent
Subject	9.8 Approval of the Contract Renewal with Learning Priority Software, Inc FY 22/23
Access	Public
Type	Action (Consent)
Dollar Amount	59,400.00
Budget Source	LCFF
Recommended Action	Staff recommends approval of the Contract Renewal with Learning Priority, Inc.

Public Content

Speaker: John Puglisi, Ph. D., Superintendent

Rationale:

Learning Priority will provide software development services to the Rio School district to help streamline their technology platform, conduct a series of reading assessments using LP, Inc reading tools district wide for students in grade 2-7, inclusive of testing, report development, content and professional development, conduct a series of reading assessment using LP, Inc reading tools district wide for students in kindergarten and 1st grades including Early literacy letter identification, Early literacy sight word (irregular words), and phonics skills test.

LP202223.pdf (279 KB)

Administrative Content

Executive Content

Our adopted rules of Parliamentary Procedure, Robert's Rules, provide for a consent agenda listing several items for approval of the Board by a single motion. Most of the items listed under the consent agenda have gone through Board subcommittee review and recommendation. Documentation concerning these items has been provided to all Board members and the public in advance to assure an extensive and thorough review. Items may be removed from the consent agenda at the request of any board member.

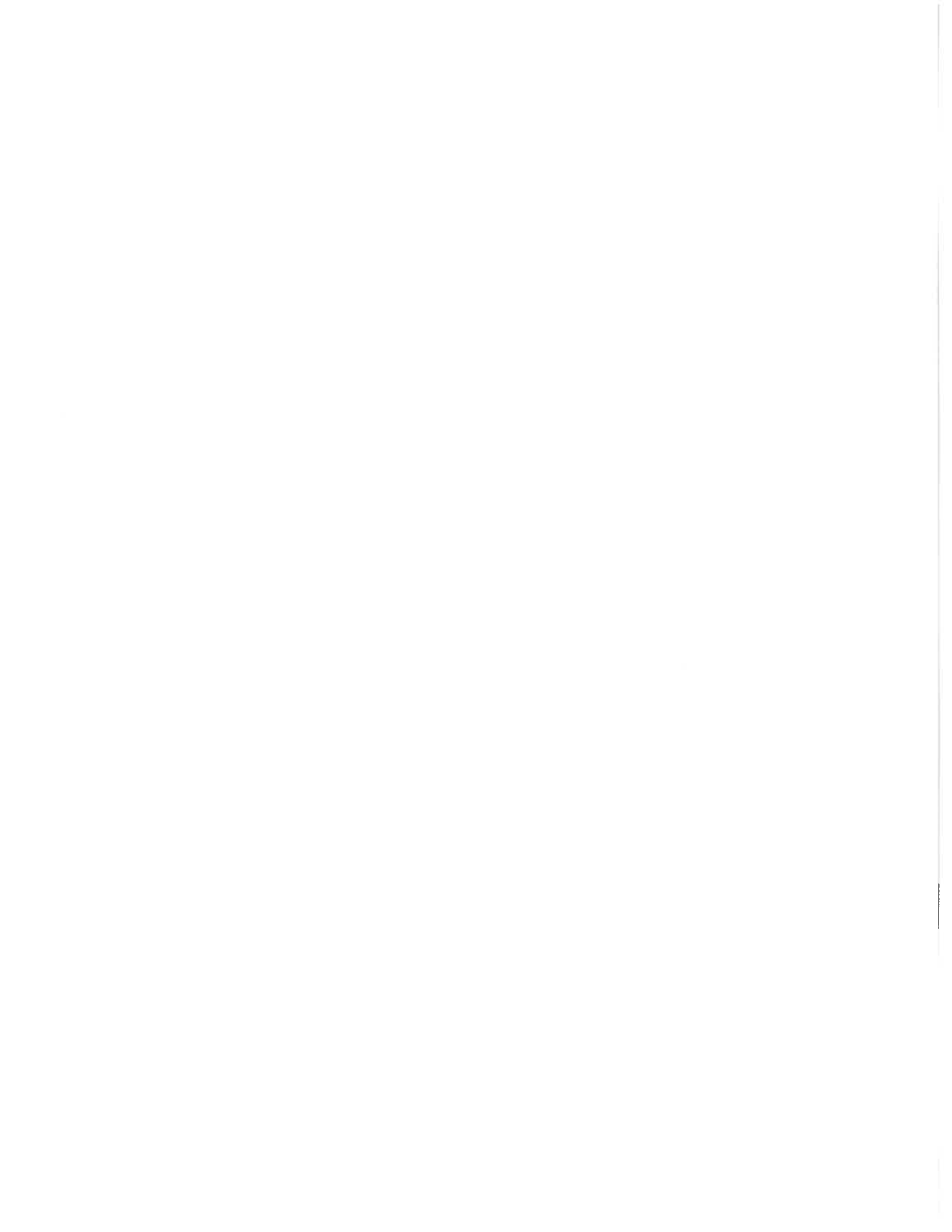



SHORT FORM SERVICES AGREEMENT

This Agreement is intended to be used for low cost, low risk, short-term services. This Services Agreement (the "Agreement") is made and entered into this day of July 1, 2022, by and between Rio School District, (hereinafter "District") and Learning Priority, Inc., 1398 East Hillcrest Drive #222, Thousand Oaks, CA 91362 (hereinafter "Provider").

Learning Priority, Inc
Provider

Telephone Number

Street Address

City, State, Zip code

E-mail Address

Tax Identification Number:

SERVICES

Description of Services

- Provide software development services to the Rio School district to help streamline the district's technology platform.
- Provide the District the Literacy Support Team, LST service. LST will focus on blending technology, the human factor, assessment, learning, mentoring, and data visualization directly to students. LST will provide data and other resources to staff and parents.
- Conduct a series of reading assessments using LP, Inc reading tools district wide for students in grade 1st-8th, inclusive of testing, report development, content and professional development.

Date of Service July 1, 2022-June 30, 2023

FEES

Compensation for Services \$4950 per month

PAYMENT. District will pay the Provider after receipt of an invoice, net 30 days.

CONDITIONS. Provider will have no obligation to provide services until the District returns a signed copy of this Agreement.

NATURE OF RELATIONSHIP. The parties agree the relationship created by this Agreement is that of an independent contractor.

AUTHORITY. Provider represents and warrants that Provider has all requisite power and authority to conduct its business and to execute, deliver, and perform this Agreement.

BINDING EFFECT. This Agreement shall inure to the benefit and shall be binding upon all of the parties to this Agreement, and their respective successors in interest or assigns.

TERMINATION OR AMENDMENT. This Agreement may be terminated or amended in writing at any time by mutual written consent of all of the parties to this Agreement, and may be terminated by either party for any reason by giving the other party 30 days advance written notice.

NON-DISCRIMINATION AND EQUAL EMPLOYMENT OPPORTUNITY. Provider represents and agrees that it does not and shall not discriminate against any employee or applicant for employment because of race, religion, color, sex, or national origin.

GOVERNING LAW AND VENUES. This Agreement shall be interpreted in accordance with the laws of the State of California. If any action is brought to interpret or enforce any term of this Agreement, the action shall be brought in state or federal court situated in the County of Ventura, State of California.

ARBITRATION. Any dispute arising under this Agreement, including, without limitation, all disputes relating in any manner to the performance or enforcement of this Agreement shall be resolved by binding arbitration in Ventura County pursuant to the rules of the American Arbitration Association.

ATTORNEYS FEES. In the event of any action or proceeding to interpret or enforce the terms of this Agreement, the prevailing party, as determined by the court or arbitrator, shall be entitled to recover its reasonable attorneys fees and costs incurred in connection with such actions or proceeding.

INDEMNIFICATION. Provider agrees to defend, indemnify, and hold harmless District, its officers, agents, employees, and/or volunteers from any and all claims, demands, losses, damages and expenses, including legal fees and costs, or other obligations or claims arising out of any liability or damage to person or property, or any other loss, sustained or claimed to have been sustained arising out of activities of the Provider or those of any of its officers, agents, employees, or subcontractors of Provider, whether such act or omission is authorized by this Agreement or not. Provider shall also pay for any and all damage to the Real and Personal Property of the District, or loss or theft of such Property, done or caused by such persons. District assumes no responsibility whatsoever for any property placed on District premises by Provider, Provider's agents, employees or subcontractors. Provider further hereby waives any and all rights of subrogation that it may have against the District. The provisions of this Agreement do not apply to any damage or losses caused solely by the negligence of the District or any of its officers, agents, employees, and/or volunteers.

INSURANCE. Provider, at its own cost and expense, shall procure and maintain during the term of this Agreement, policies of insurance for the following types of coverage:

- Workers' Compensation Insurance. Provider shall procure and maintain, during the term of this Agreement, Workers' Compensation Insurance, as required by California law, on all of its employees engaged in work related to the performance of this Agreement. In the case of any activities which are hired or subcontracted, Provider shall require all vendors and subcontractors to provide Workers' Compensation Insurance for all of the vendor's and/or subcontractor's employees to be engaged in such activities unless such employees are covered by the protection afforded by the Provider's Workers' Compensation Insurance.
- Commercial General Liability Insurance. Provider shall procure and maintain, during the term of this Agreement, not less than the following General Liability Insurance coverage in the amounts of \$1,000,000 per occurrence and \$2,000,000 aggregate.

Commercial General Liability insurance shall include products/completed operations, broad form property damage, and personal and advertising injury coverage.

Any and all vendors and subcontractors hired by Provider in connection with the activities described in this Agreement shall maintain such insurance unless the Provider's insurance covers the subcontractor and its employees.

- Other Coverage as Dictated by the District. Provider shall procure and maintain, during the term of this Agreement, Abuse and Molestation coverage in the amounts of \$1,000,000 per occurrence and \$2,000,000 aggregate.

Certificates of Insurance. Provider and any and all vendors and subcontractors working for Provider shall provide certificates of insurance to the District as evidence of the insurance coverage required herein, not less than 15 days

prior to commencing the proposed activity, and at any other time upon the request of the District. Certificates of such insurance shall be filed with the District on or before commencement of the services under this Agreement.

Provider's and any and all Provider subcontractor's Commercial General Liability insurance and Abuse and Molestation coverage shall name the District, its employees, and school board members as additional insureds.

Insurance written on a "claims made" basis is to be renewed by the Provider and all Provider subcontractors for a period of three (3) years following termination of this Agreement. Such insurance must have the same coverage and limits as the policy that was in effect during the term of this agreement, and will cover the Provider for all claims made.

ACKNOWLEDGEMENT AND AGREEMENT

I have read this agreement and agree to its terms

Provider signature

Date

DISTRICT APPROVAL

District Administrator

Signature

Date



Agenda Item Details

Meeting	Jun 29, 2022 - RSD Regular Board Meeting
Category	9. Consent
Subject	9.9 Approval of the Certification of Signatures fiscal year 2022/2023
Access	Public
Type	Action (Consent)
Fiscal Impact	No
Budgeted	No
Recommended Action	Staff recommends the Board approve the Certification of Signatures for the 2022/2023 fiscal year.

Public Content

Speaker:
Wael Saleh, Assistant Superintendent, Business Services

Rationale:

Pursuant to Education Codes Sections 42632 & 42633 certification of signatures is required annually at the beginning of each fiscal year or with a change of administrative personnel or change of officers to the board.

20220527_RIO SCHOOL DISTRICT CERTIFICATION OF SIGNATURES.pdf (631 KB)

Administrative Content

Executive Content

Our adopted rules of Parliamentary Procedure, Robert's Rules, provide for a consent agenda listing several items for approval of the Board by a single motion. Most of the items listed under the consent agenda have gone through Board subcommittee review and recommendation. Documentation concerning these items has been provided to all Board members and the public in advance to assure an extensive and thorough review. Items may be removed from the consent agenda at the request of any board member.

RIO SCHOOL DISTRICT CERTIFICATION OF SIGNATURES

I, John D. Puglisi, Ph.D., Secretary to the Board of Education of Rio School District of Ventura County, California hereby certify that the signatures shown below are the verified signatures of the members of the governing Board of the above-mentioned named school district (Part 1). Verified signatures of the person or persons authorized to sign orders drawn on the funds of the school district, Notice of Employment, Contracts, etc., appear in Part 2. These certifications are made in accordance with the provisions of Education Code Section indicated.* If those authorized to sign orders shown in Part 2 are unable to do so, the law requires the signatures of the majority of the Governing Board.

The approved signatures will be considered valid for July 1, 2022 thru June 30, 2023

Date of Board Action: June 22, 2022

Signature: _____

John Puglisi
Secretary of the Board

PART 1

Signatures of Members of the Board

Signature: _____
Print/Type: Kristine Anderson
Title: President

Signature: _____
Print/Type: Eleanor Torres
Title: Trustee

Signature: _____
Print/Type: Linda Armas
Title: Trustee

Signature: _____
Print/Type: Edith Martinez-Cortes
Title: Trustee

Signature: _____
Print/Type: _____
Title: Trustee

Signature 
Print Type: Nadia Villapudua
Title: Director of Pupil Support Services
Authorized to Sign: G. 2 inclusive

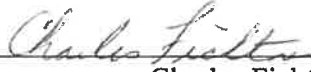
Signature 
Print Type: Charles Fichtner
Title: Director of Maintenance and Operations
Authorized to Sign: G. 2-3 inclusive

Signature 
Print Type: Lacey Piper
Title: Director of Child Nutrition and Wellness
Authorized to Sign: G. 2-5 inclusive

Signature 
Print Type: Jarkko Myllari
Title: Director of Technology
Authorized to Sign: G. 2-5 inclusive

PART 2

Signatures of Personnel and/or Members of the Governing Board authorized to Sign Checks, Orders for Salary Payment, Notices of Employment, Contracts, etc. Please list after each name all items that a person is authorized to sign.

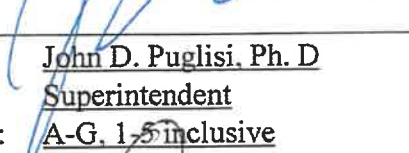
Signature 
Print/Type: John D. Puglisi, Ph. D
Title: Superintendent
Authorized to Sign: A-G, 1-5 inclusive

Signature 
Print/Type: Oscar Hernandez
Title: Assistant Superintendent of Educational Services
Authorized to Sign: A-G, 1-4 inclusive

Signature 
Print/Type: Wael Saleh
Title: Assistant Superintendent Business Services
Authorized to Sign: A-G, 1-5 inclusive

Signature 
Print/Type: Rebecca Rocha
Title: Director of Human Resources
Authorized to Sign: A-G, 1-4 inclusive

Signature 
Print Type: Veronica Rauschenberger
Title: Director of School and Systems Improvement
Authorized to Sign: G, 2 inclusive

Signature 
Print/Type: Celeste Perdue
Title: Director of Fiscal Services
Authorized to sign: B-G, 2-5 inclusive

The following documents must be filed with School Business and Advisory Services:

- A. Authorization to sign reports, budgets, and all documents requiring signature of Secretary or Clerk.
- B. Authorization to approve payroll orders.
- C. Authorization to approve commercial check orders.
- D. Authorization to sign collection reports to the county.
- E. Authorization to sign board approved budget transfers.
- F. Authorization to sign Interfund and Intrafund transfers.
- G. Authorization to sign Contracts after Board Approval.

Examples of documents requiring district authority (not required to be filed with School Business and Advisory Services):

- 1. Authorization to sign Employment Contracts.
- 2. Appointment of authorized agents, for federal and state applications.
- 3. Appointment of representatives to acquire surplus property.
- 4. Authorization to sign cafeteria reports.
- 5. Authorization to sign checks on district bank accounts, i.e., cafeteria; clearing account.

Districts must notify School Business and Advisory Services in writing and submit Board Approved signature authorization amendments as staff and / or organizational changes occur midyear.

9.10



Agenda Item Details

Meeting	Jun 29, 2022 - RSD Regular Board Meeting
Category	9. Consent
Subject	9.10 Approval of agreement with School Services of California for consulting services for 2022/2023
Access	Public
Type	Action (Consent)
Fiscal Impact	Yes
Dollar Amount	4,260.00
Budgeted	Yes
Budget Source	General Fund
Recommended Action	It is recommended that the Board approve the contract between RSD and School Services of California for consulting services for 2022/2023.

Public Content

Speaker:
Wael Saleh, Assistant Superintendent, Business Services

Rationale:
The contract between School Services of California and Rio School District commenced August 1, 2022 and will end on July 31, 2023. The consulting services consist of issues related to school finance including the delivery of an electronic Fiscal Report on policies and local impact, as well as an Analysis of the Governor's Proposals for the State Budget and K-12 Education.

Rio SD Agreement with School Services of Calif..pdf (304 KB)

Administrative Content

Executive Content

Our adopted rules of Parliamentary Procedure, Robert's Rules, provide for a consent agenda listing several items for approval of the Board by a single motion. Most of the items listed under the consent agenda have gone through Board subcommittee review and recommendation. Documentation concerning these items has been provided to all Board

members and the public in advance to assure an extensive and thorough review. Items may be removed from the consent agenda at the request of any board member.

AGREEMENT FOR SPECIAL SERVICES
Fiscal Budget Services

This is an Agreement between the **RIO SCHOOL DISTRICT**, hereinafter referred to as "Client," and **SCHOOL SERVICES OF CALIFORNIA INC.**, hereinafter referred to as "Consultant," entered into as of August 1, 2022.

RECITALS

WHEREAS, the Client needs assistance regarding issues of school finance, legislation, school budgeting, and general fiscal issues; and

WHEREAS, the Consultant is professionally and specially trained and competent to provide these services; and

WHEREAS, the authority for entering into this Agreement is contained in Section 53060 of the Government Code and such other provisions of California law as may be applicable;

NOW, THEREFORE, the parties to this Agreement do hereby mutually agree as follows:

1. The Consultant agrees to perform such duties relating to issues of school finance, including:
 - a. Electronic delivery of the *Fiscal Report* containing information on issues of school finance, budgets, or practices and policy issues that impact local educational agency fiscal policies, and an electronic copy of the *Analysis of the Governor's Proposals for the State Budget and K-12 Education*.
 - b. An analysis of all major school finance/fiscal legislation and reports on its legislative/executive branch progress
 - c. Eight hours of service annually as the Client directs on fiscal issues, including: analysis of specific revenue or expenditure issues, analysis of specific legislative or regulatory issues, and a "quick query" service to provide telephone response to specific fiscal questions of the Client.

Services for which the base service hours may not be used, include: mandate questions, Client-specific economy, efficiency, or management consulting services, including, but not limited to, efficiency or management studies, demographic or school facility studies; special education studies; fiscal health analysis, and/or an in-depth budget review, direct collective bargaining or factfinding assistance; legislative representation or advocacy; fiscal analysis for purposes of collective bargaining, appearance as an expert witness, provision of depositions or declarations for local educational agency legal issues; major customized research projects or studies; or, on-site speeches or presentations.
 - d. Participation at the Consultant's school finance conferences and workshops at the Consultant's client rate.
2. The Client agrees to pay to the Consultant for services rendered under this Agreement:
 - a. \$4,260 annually, plus expenses, or payable at \$355 per month, plus expenses, for the services listed in Item 1 above, upon billings from the Consultant

- b. For all requested services in excess of eight direct service hours as indicated in Item 1c above in a 12-month period, the applicable hourly rate for the person(s) performing the services shall apply
 - c. "Hours" are defined as hours of direct service to the Client, as well as reasonable travel time to and from the Client's site
 - d. "Expenses" are defined as actual, out-of-pocket expenses, such as travel, meals, shipping, and duplication of materials
3. The term of this contract shall be for the period of one year, beginning August 1, 2022, and terminating July 31, 2023. Agreement may be terminated prior to July 31, 2023, by either party on 30 days' written notice. In the event that the Client elects to terminate services at the end of the Agreement, the Client shall give a 30-day written notice of nonrenewal. The Consultant will provide continuing services for 90 days after the expiration date of the Agreement or until the Client provides written notice. The Client is responsible for these accrued charges and the Consultant may bill these additional days. In case of cancellation, the Client shall be liable for any costs accrued to the date of cancellation under Item 2 above.
4. It is expressly understood and agreed to by both parties that the Consultant, while carrying out and complying with any of the terms and conditions of this Agreement, is an independent contractor and is not an employee of the Client.

IN WITNESS WHEREOF, the parties have caused this Agreement to be executed as indicated below:

By: _____

Date: _____

Print Name

Job Title
Rio School District

By:  _____
John D. Gray
President/CEO
School Services of California Inc.

Date: June 17, 2022

Contract period: 08-01-22 to 07-31-23

P.O. # _____

**ADDENDUM A
TO SPECIAL SERVICES AGREEMENT**

As a client of School Services of California Inc., you have the option of purchasing either or both of our **CADIE** and **SABRE** reports at the client rate. The following information describes the **CADIE** and **SABRE** reports, and the form at the bottom of the page to order the reports.

The **Comparative Analysis of District Income and Expenditures (CADIE)** is a comprehensive computer-generated report comparing your district's revenues and expenditures to those of 40 other districts (two reports with 20 districts in each) of your choice throughout the state. Well over 300 comparisons are made using SACS, CBEDS and CalPads data.

The **CADIE** includes comparative graphic data expenditures by ADA, tabular information showing per ADA and percentage distribution of district revenues and expenditures, staffing levels, and tables that show—on an ADA and percentage basis—how your district spent its dollars for the prior three years. The report is comprehensive, yet easy to use.

The **Salary And Benefits Report (SABRE)** is generated from the CDE's Certificated Teachers Salary and Benefit data (Form J-90) and provides up to 38 side-by-side comparisons of your district with those of 40 other districts (two reports with 20 districts in each) of your choice on certificated salaries, health and welfare benefits, and work days.

The **SABRE** includes ten graphical displays and 27 comparison tables with side-by-side analysis for certificated non-management. It also includes the actual salary and benefit schedules and other selected data important for compensation evaluation in an easy-to-read format.

The analytical uses of the **CADIE** and **SABRE** reports are unlimited. If these products are needed for negotiations, they may be fully reimbursable as part of your mandated cost claim if you have chosen to file mandate claims for this year.

WITH PURCHASE, YOU ARE ENTITLED TO TWO CADIES AND TWO SABRES

Please check the appropriate items below: Current year 2020-21 Next year 2021-22**

Electronic Version:

___ CADIE only \$500
___ SABRE only \$350
___ CADIE & SABRE \$800

Hardcopy Version:

___ CADIE only \$600
___ SABRE only \$450
___ CADIE & SABRE \$1000

___ Use the same districts as last year
___ Use districts of similar type and size
___ Use districts geographically close to mine
___ Use districts with similar unduplicated pupil percentage

Reports are a year behind as the data is released by the CDE.

**Next year: SABRE will be released in December 2022, CADIE will be released in March 2023

District Name: _____

Contact Name: _____

Address (no P.O. boxes please): _____

Telephone with extension: _____

Email Address: _____

Signature: _____

Print Name: _____ Date: _____

By completing this Addendum A, and submitting with our contract, the Client agrees to pay for these reports upon receipt of the products and appropriate billing.

9.11



Agenda Item Details

Meeting	Jun 29, 2022 - RSD Regular Board Meeting
Category	9. Consent
Subject	9.11 Approval of Contract with SAGE Realty Group for July 1, 2022 - June 30, 2023 for Consulting Services
Access	Public
Type	Action (Consent)
Fiscal Impact	Yes
Dollar Amount	114,000.00
Budgeted	Yes
Budget Source	Developer Fees
Recommended Action	It is recommended that the board approve the contract between Rio School District and Sage Realty Group for the period July 1, 2022 through June 30, 2023 for Consulting Services.

Public Content

Speaker:
John Puglisi, Superintendent

Rationale:
SAGE Realty Group provides consulting services to the District regarding site facilities and funding requirements and strategies, Continued Master Planning, CEQA Oversight, Program Planning, Implementation Planning and Construction Negotiations and Pre-Qualification Coordination of Contractors, and G.O. Bond Distribution for State Matching Funds. This contract is for July 1, 2022 through June 20, 2023.

\$9,500.00 per month x 12 months
\$114,000.00 Total

SAGE Contract 22-23.pdf (632 KB)

Administrative Content

Executive Content

Our adopted rules of Parliamentary Procedure, Robert's Rules, provide for a consent agenda listing several items for approval of the Board by a single motion. Most of the items listed under the consent agenda have gone through Board subcommittee review and recommendation. Documentation concerning these items has been provided to all Board members and the public in advance to assure an extensive and thorough review. Items may be removed from the consent agenda at the request of any board member.

PROPOSED SCOPE OF WORK / AUTHORIZATION OF COSTS

Services Provided for:

Rio School District (District)
1800 Solar Drive
Oxnard, CA 93030

Authorized Representative:

John D. Puglisi, Ph.D.
District Superintendent
Phone #: (805) 485-3111

Services Provided by:

SRGI (Consultant)
2945 Townsgate Rd. #200
Westlake Village, CA 91361

Principal Consultant:

Dr. Joel Kirschenstein, President
Phone #: (805) 497-8557 x223
joel@sagerealtygroup.com

In Association with:

Lisa Kaplan and Associates, Jennifer Vail

Project Duration: July 2022 – June 2023

Scope of Work: District site facilities and funding requirements and strategies / Continued FF Master Planning / CEQA Oversight / Program Planning / Implementation Planning & Construction Negotiations (as requested) / G.O. Bond Distribution for State Matching Funds / OPSC Funding Applications / Enrollment Projections

I. Facilities Finance Master Planning and Implementation Planning

- A. Assist with preparation and coordination of agendas for team meetings (as needed) and attend team meetings regarding compliance for state matching funds.
- B. Facilitate implementation and Master Planning projections and data items.
- C. Facilitate special study consultants & CEQA mitigation and monitoring requirements for all projects in general, and RDV expansion in particular.
- D. Coordinate M.O.T., District office relocation efforts (exclusive of commissions).
- E. Assist with Preparation of Board agenda items and progress reports for facility and eligibility projects.
- F. Continue to work with District legal counsel and Staff re: aforementioned items as needed.
- G. Assist with implementing K-8 school expansion / CDE occupancy items.

II. Update OPSC Funding Applications for all school projects as needed

- A. Prepare and coordinate documentation for updated OPSC funding applications.
- B. Follow-up with OPSC re: all response letters and comments and questions.
- C. Prepare Board related agenda items for modernization and new construction items.
- D. Assist CBO to identify District matching funds and related self-certification items for signature.

III. Prepare New or Revised Construction Eligibility Application for District Wide Projects

- A. Prepare and coordinate documentation for new construction eligibility update and submittal to OPSC for Phase II Rio del Sol (\$4 million +/-) OPSC reimbursement.
 - B. Follow-up and amend accordingly
 - C. Track applications and project fund releases (in progress).
 - D. Recommend timing and assist CBO for submittal (all applications).
-

- E. Submit applications as required upon OPSC notices.

IV. Update Enrollment Projections and Revised Capacity Analysis Update for All School Boundary Analysis

- A. Prepare revised cohort enrollment projections by school site and district-wide.
- B. Research and update enrollment projections for new residential development.
- C. Update capacity data and overlay updated enrollments with updated capacity determination.
- D. Draft updated enrollment projection and capacity analyses for Facilities Finance Master Plan Tables Update and School Boundary analysis as related to all new proposed construction (in progress).

V. Modernization Eligibility Update and Funding Application

- A. Prepare and coordinate documentation for modernization funding application for Rio Real ES for submittal to OPSC and other eligible projects with District architect.

VI. Continued Assistance with Project Related Items

- A. Review general conditions as needed, negotiation of amendments to contracts and provide advice/direction to the District (as requested).
- B. Contractor analysis and negotiations with district counsel (as needed).
- C. Assist with business services/related items as requested including all pre-qual items.
- D. Attendance at open and closed sessions as needed, conference calls and preparation of Board agenda items (and subcommittees as requested).

VII. Continued Master Planning Components and Related Items as Requested, including:

- A. City MOU
 - Continued meetings with City, District staff and special counsel. Reports to Board in closed session, contact representation of Riverpark site counsel and council members (in progress)
- B. Rose Avenue
 - Meetings with Superintendent, Staff and construction manager to identify appropriate acreage for acquisition. Coordinate with Tetra Tech and Wael for special study contracts for Wael's approval.
- C. Rio Urbana Coordination
 - Continued final follow-up with Rio Urbana project for count in state funding and temporary auto parking for white fleet.
- D. MOT Relocation
 - Meetings with Superintendent, construction manager and District MOT staff re: project management for interim site and/or transfer staff MOT criteria to Rose Ave site including size, utilities, Board requirements and meetings with LAFCO and City staff for final utility hookup approvals.
- E. Ag/Farm Program
 - Continue to coordinate all elements with District staff for ag/farm program and grants.
- F. Riverpark
 - Revised Developer Fee negotiations with Riverpark re: potential new 1,300 RDU re: zone for increased mitigation fees and mitigation agreement.
- G. Ace Charter School
 - Assist with potential use of District property (RDV) for Ace Charter School.

VIII. District G.O. Bond (new):

- A. Coordinate G.O. Bond and Developer Fee matching funds and related items (to invoice COI directly with underwriter when applicable).
- B. Conference calls and scoping with bond underwriters and District finance consultants.
- C. Coordinate with Supt. and assist supt. projects to be included in new Bond for Board approvals.
- D. Assist with preparation of project component sections of Board docs.
- E. Assist with final sale and scheduling of proceeds for projects.
- F. Assist with Board presentations.

AGREED BUDGET / COMPENSATION AMOUNT:

SRGI Employee	Rate/hour	Estimated Fee*
Principal	\$225.00	Tasks I-VII: \$9,500.00/month* Task VIII: TBD (to issue COI directly to underwriter) *NTE amount can be exceeded only with written District approval for items not anticipated in this original scope of work (if applicable).
Senior Associate	\$185.00	
Associate	\$125.00	
Administrative Assistance	\$75.00	

Note 1: Inclusive for all Time & Material for Joel Kirschenstein, Lisa Kaplan and Jennifer Vail for work considered under this Scope of Work.

Note 2: Ms. Kaplan to submit separate retainer agreements for legal work.

Note 3: Real estate commissions not included (if applicable).

Submitted by Sage Realty Group Inc.

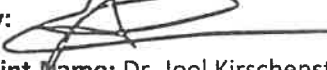
By: 

Print Name: Dr. Joel Kirschenstein

Title: President

Date: June 1, 2022

Agreed and Accepted by Client:

By:

Print Name: John D. Puglisi, Ph.D.

Title: District Superintendent

Date:

9.12



Agenda Item Details

Meeting	Jun 29, 2022 - RSD Regular Board Meeting
Category	9. Consent
Subject	9.12 Approval of Annual List of Pre-Qualified Bidders from Quality Bidders for 2022/2023
Access	Public
Type	Action, Discussion
Fiscal Impact	Yes
Budgeted	Yes
Budget Source	There will be no impact to the District's General Fund. The District's costs will be funded out of dedicated facilities bond and related mitigation fee funds.
Recommended Action	The Board is asked to approve the Pre-Qualified Bidder list from Quality Bidders for the 22/23 year.
Goals	Goal 1-Improved student achievement at every school and every grade in all content areas

Public Content

Speaker: Wael Saleh, Assistant Superintendent of Business Services

Background

California Assembly Bill 1565 (AB 1565), passed in 2014 & was updated with AB 2031 (2018) states that if the governing board of the district uses funds received pursuant to the Leroy F. Greene School Facilities Act of 1998 for contracts totaling \$1,000,000, that the governing board of the district shall require prospective bidders (General and Mechanical, Electrical and Plumbing [MEP] subcontractors) to complete and submit, to the district, a standardized prequalification questionnaire and financial statement. This pre-qualification questionnaire must meet the minimum requirements set forth by the Department of Industrial Relations (DIR) for pre-qualification.

Administrative Regulation 3311 (AR 3311) and Public Contract Code (PCC) 20111.5, state that the district may establish a procedure for prequalifying bidders on a quarterly basis or yearly basis and may authorize that pre-qualification be considered valid for up to one calendar year following the date of the initial pre-qualification. PCC 20111.6 requires all prospective bidders to complete and submit to the governing board of a school district a standardized pre-qualification questionnaire and financial statement for board adoption for certain projects. This applies to prime contractors and MEP sub-contractors.

In 2019, the Board approved the contract with Quality Bidders to provide a yearly online pre-qualification application process, renewed the contract each year thereafter. Applications received by Quality Bidders have been reviewed by staff, and the attached pool of pre-qualified bidders is recommended for approval. Once eligible bidders have been notified of their approval by the District, their approval shall be renewed annually via the same online process. All interested parties in contracting for school construction projects with the District, had over a month to submit their pre-qualification package to Quality Bidders. With the help of the District's Construction Manager, numerous emails and calls have been placed to current or past contractors and sub-contractors encouraging them to renew or submit the required documentations for pre-qualification.

Ten (10) days after Board approval of this bidder list, the District may send out documents requesting bids from the pre-qualified list for any future facility project.

Attached is a list of pre-qualified bidders.

Rationale:

Adoption of an online pre-qualification process, which is compliant with the law, will save significant District staff time by automating the pre-qualification and reference checks of all prospective bidders. In neighboring Districts, hundred of prospective bidders have gone through this online pre-qualification process and are familiar with the process. Once eligible bidders have been notified of their approval by the Board of Trustees, their approval can be renewed annually via the same on line process.

Application Status Report.pdf (441 KB)

Administrative Content

Executive Content

Application Status Report

For Rio School District
Created 06/19/2022 02:32 PM

Company	Name	Address	Phone	Fax	Email	License Number	License Classifications	Status	Status Date	Expires
ACCO ENGINEERED SYSTEMS INC	Cindi Adler	888 East Walnut Street, Pasadena, CA 91101(HQ)	818-244-6571	000-000-0000	cadler@accoes.com	120696_	A (General Engineering Contractor), B (General Building Contractor), C-4 (Boiler, Hot Water Heating and Steam Fitting Contractor), C-10 (Electrical Contractor), C-20 (Warm-Air Heating, Ventilating and Air-Conditioning Contractor), C-36 (Plumbing Contractor), C-38 (Refrigeration Contractor), C-16 (Fire Protection Contractor)	APPROVED	06/09/2022	06/09/2023
ACH Mechanical Contractors, Inc.	Amanda Sanchez	411 Business Center Court, Redlands, CA, 92373	909-307-2850	909-307-2853	amandas@achmechanical.com	780560_	C-20 (Warm-Air Heating, Ventilating and Air-Conditioning Contractor)	APPROVED	06/01/2022	06/01/2023
AMG & Associates, Inc.	Albert M. Giacomazzi	26535 Summit Circle, Santa Clarita, CA 91350	661-251-7401	661-251-7405	estimating@amgassociatesinc.com	881824_	B (General Building Contractor), A (General Engineering Contractor), HAZ (hazardous Substance Removal Certification), ASB (Asbestos Certification)	APPROVED	06/13/2022	06/13/2023
APEX FIRE PROTECTION, INC.	ZARE BABAYAN	2155 VERDUGO BLVD. #220, MONTRUSE, CA, 91020	818-957-3400	818-957-3404	apexfireinc@yahoo.com	954286_	C-16 (Fire Protection Contractor)	APPROVED	06/01/2022	06/01/2023
Air Design Solutions	Maricela Martinez	403 S Montebello Blvd, Montebello, CA, 90640	323-727-7500	323-727-7071	maricela@airdesign1.com	953818_	C-20 (Warm-Air Heating, Ventilating and Air-Conditioning Contractor)	APPROVED	06/13/2022	06/13/2023
Air Management Industries Incorporated	Lloyd Jackson	8351 Elm Ave #102, Rancho Cucamonga, CA, 91730	909-945-0041	909-945-9994	airmgmt@tstonramp.com	783245_	C-20 (Warm-Air Heating, Ventilating and Air-Conditioning Contractor), C-61 (Limited Specialty)	APPROVED	06/13/2022	06/13/2023
American Building Automation, Inc.	Adrian Rosales	5528 Everglades Street, Suite A, VENTURA, CA, 93003	805-658-0165	805-658-1865	estimating@abainc.biz	756997_	B (General Building Contractor), C-7 (Low Voltage Systems Contractor), C-10 (Electrical Contractor), C-20 (Warm-Air Heating, Ventilating and Air-Conditioning Contractor)	APPROVED	06/01/2022	06/01/2023

Company	Name	Address	Phone	Fax	Email	License Number	License Classifications	Status	Status Date	Expires
Audio Associates of San Diego dba Audio Associates	Sundi Browne	1497 Jayken Way, Chula Vista, CA, 91911	619-461-9445	619-461-9469	sbrowne@audioassociates.com	728789_	C-7 (Low Voltage Systems Contractor)	APPROVED	06/01/2022	06/01/2023
Avidex Industries LLC	Felicia McGinn	20382 Hermans Cirle, Lake Forest, CA, 92630	949-428-6333	949-428-6334	biddesk@avidex.com	981651_	C-7 (Low Voltage Systems Contractor), C-10 (Electrical Contractor)	APPROVED	06/01/2022	06/01/2023
BALFOUR BEATTY CONSTRUCTION LLC	Alexis D'Epagnier	13520 Everling Creek Drive, North, Suite 270, CA, 92128	858-635-7400 x39	858-635-7401	adepagnier@balfourbeatty.com	979126_	A (General Engineering Contractor), B (General Building Contractor)	APPROVED	06/01/2022	06/01/2023
BODAGGER ENTERPRISES INC dba BADAGGER BUILDERS	Diego Garcia	1686 Lirio Ave, Ventura, CA, 93004	805-647-0349	805-212-8130	bodaggerbuilders@gmail.com	905498_	A (General Engineering Contractor), B (General Building Contractor), C-54 (Ceramic and Mosaic Tile Contractor)	APPROVED	06/13/2022	06/13/2023
BORBON INCORPORATED	Arisbet Picazo	2560 West Woodland Drive Anaheim CA 92801	714-994-0170	714-994-0641	arisbet@borbon.net	351557_	C-33 (Painting and Decorating Contractor)	APPROVED	06/13/2022	06/13/2023
BRAVO CONCRETE CONSTRUCTION SERVICES, INC.	KATHLEEN BOHANNON	681 W. LA CADENA DRIVE, RIVERSIDE, CA, 92501	951-680-9009	951-680-9028	kathy@bravoconcreteshop.com	856049_	A (General Engineering Contractor), B (General Building Contractor), C-8 (Concrete Contractor)	APPROVED	06/13/2022	06/13/2023
Bali Construction, Inc.	Grant Wood	9852 E. Joe Vargas Way, South El Monte, CA, 91733	626-442-8003	626-442-8315	estimating@baliconstruction.com	524540_	A (General Engineering Contractor), C-4 (Boiler, Hot Water Heating and Steam Fitting Contractor), C-16 (Fire Protection Contractor), C-36 (Plumbing Contractor)	APPROVED	06/13/2022	06/13/2023
Blum and Sons Electric Inc	Cassandra Hernandez	606 Linden Avenue, ATTN: Cassandra Hernandez, Carpinteria, CA, 93013	805-684-1010		blumpma@blumelectric.com, projectassist@blumelectric.com	494283_	C-10 (Electrical Contractor)	APPROVED	06/13/2022	06/13/2023
C.W. Driver, LLC	Jennifer Vasquez	468 N. Rosemead Blvd., Pasadena, CA, 91107	626-351-8800	626-351-8880	jvasquez@cwdriver.com	1009002	B (General Building Contractor)	APPROVED	06/16/2022	06/16/2023
CENTER GLASS CO NO 9	Michelle Ortiz	3910 MARKET ST STE A, Ventura, CA, 93003	805-642-0149	805-642-8421	michelle@centerglasscompany.com	244559_	C-17 (Glazing Contractor)	APPROVED	06/01/2022	06/01/2023
CTG Construction Inc. dba C.T. Georgiou Painting Co.	Costas Georgiou	433 Lecouvreur Ave., Wilmington, CA, 90744	310-834-8015	310-834-1660	matlab@ctgconstruction.net	635916_	B (General Building Contractor), C-33 (Painting and Decorating Contractor)	APPROVED	06/17/2022	06/17/2023

Company	Name	Address	Phone	Fax	Email	License Number	License Classifications	Status	Status Date	Expires
Climatec, LLC	Stephany Beiknap	13715 Stowe Dr., Poway, CA, 92064	858-391-7001	858-848-2021	SBeiknap@climatec.com	991066_	B (General Building Contractor), C-10 (Electrical Contractor), C-20 (Warm-Air Heating, Ventilating and Air-Conditioning Contractor)	APPROVED	06/17/2022 2	06/17/2022 3
Control Electric Inc.	Neil Fox	840 E Parkridge Ave, Suite 106, Corona, CA, 92879	951-739-7399	951-739-7398	nfox@controlelectric.net	809558_	C-10 (Electrical Contractor), C-20 (Warm-Air Heating, Ventilating and Air-Conditioning Contractor)	APPROVED	06/16/2022 2	06/16/2022 3
David M. Bertino Manufacturing, Inc.	Cindy Hutton	P.O. Box 1820, Colton, CA, 92335	909-888-9122	909-381-5577	cindy@davidmberthnomanufacturing.com	520857_	C-6 (Cabinet, Millwork and Finish Carpentry Contractor)	APPROVED	06/01/2022 2	06/01/2022 3
Digital Technologies, Inc.	Daniel Villarreal	760 S. Rochester Ave, Suite E, Ontario, CA, 91761	909-563-8703	909-657-9153	dwillarrea@digitaltech.us.com	894551_	B (General Building Contractor), C-7 (Low Voltage Systems Contractor), C-10 (Electrical Contractor), C-10 (Electrical Contractor), C-33 (Painting and Decorating Contractor)	APPROVED	05/27/2022 2	05/27/2022 3
EIDIM Group Inc. dba EIDIM AV Technology	Aman Jain	6905 Oslo Cir. Suite J, Buena Park, CA, 90621	562-777-1009 x104	562-777-9120	estimate@eidim.com	824410_	B (General Building Contractor), C-7 (Low Voltage Systems Contractor), C-10 (Electrical Contractor), C-33 (Painting and Decorating Contractor)	APPROVED	06/17/2022 2	06/17/2022 3
FENCE FACTORY	DEBI AVENDANO	1606 Los Angeles Ave, Ventura, CA, 93004	805-642-3249	000-000-0000	davendano@fencefactory.com	275524_	A (General Engineering Contractor), C-13 (Fencing Contractor)	APPROVED	06/01/2022 2	06/01/2022 3
Floored Tile & Stone	Greg Zwerner	7200 Helena Place, Fontana, CA, 92336	909-574-8090	909-574-0902	greg@flooredtile.com	791250_	C-54 (Ceramic and Mosaic Tile Contractor)	RETURNED		
Fremont Millwork Co.	Sandi Hartley	2949 Onyx Ave, Klamath Falls, OR, 97603	541-884-5554	541-882-5643	shartley@fremontmillwork.com	249756_	C-6 (Cabinet, Millwork and Finish Carpentry Contractor)	APPROVED	06/16/2022 2	06/16/2022 3
Ground Breakers Construction Inc.	Marty Siebe	PO Box 520 (mail) 2292 Hayride Rd. (phys), Lebec, CA, 93243	661-248-6490 x30	661-248-6489	msiebe@gbreakers.com	823501_	A (General Engineering Contractor), B (General Building Contractor), HAZ (Hazardous Substance Removal Certification)	APPROVED	06/16/2022 2	06/16/2022 3

Company	Name	Address	Phone	Fax	Email	License Number	License Classifications	Status	Status Date	Expires
HPS Mechanical, Inc.	Alma Martinez	3100 E. Belle Terrace Bakersfield, CA 93307	661-397-2121 x8209	661-396-2589	planroom@hpsmechanical.com	793014_	A (General Engineering Contractor), B (General Building Contractor), C-4 (Boiler, Hot Water Heating and Steam Fitting Contractor), C-2 (Insulation and Acoustical Contractor), C-10 (Electrical Contractor), C-16 (Fire Protection Contractor), C-20 (Warm-Air Heating, Ventilating and Air-Conditioning Contractor), C-34 (Pipeline Contractor), C-36 (Plumbing Contractor), C-42 (Sanitation System Contractor), C-43 (Sheet Metal Contractor), C-46 (Solar Substance Removal Certification)	APPROVED	06/01/2022	06/01/2023
Hamel Contracting, Inc.	Grant Hamel	26431 Jefferson Ave., Murrieta, CA, 92562	951-600-2783	951-600-3951	grant@hamelinc.com	919635_	A (General Engineering Contractor), B (General Building Contractor), C-8 (Concrete Contractor)	APPROVED	06/16/2022	06/16/2023
J. Noble Binns Plumbing Co., Inc.	Michelle Heinrichs	3529 Pegasus Drive, Bakersfield, CA, 93308	661-615-6101	661-615-6108	michelle@binnsplumbing.com	481544_	C-36 (Plumbing Contractor), C-4 (Boiler, Hot Water Heating and Steam Fitting Contractor), C-34 (Pipeline Contractor), C-16 (Fire Protection Contractor), C-55 (Water Conditioning Contractor)	APPROVED	06/17/2022	06/17/2023
J.R. Barto Heating / Air-Conditioning / Sheet Metal Inc	Michelle Bevington	PO Box 2720, Orcutt, CA, 93455	805-928-5486	805-937-6807	lauren@jrbarto.com	738011_	B (General Building Contractor), C-20 (Warm-Air Heating, Ventilating and Air-Conditioning Contractor), C-36 (Plumbing Contractor), C-43 (Sheet Metal Contractor)	APPROVED	06/17/2022	06/17/2023
JPI Development Group, Inc.	Claudia Monge	41205 Golden Gate Circle, Murrieta, CA, 92562	951-973-7680	951-973-7690	estimating@jpiddevelopment.com	778930_	A (General Engineering Contractor), B (General Building Contractor), C-2 (Insulation and Acoustical Contractor), C-8 (Concrete Contractor), C-16 (Fire Protection Contractor), C-34 (Pipeline Contractor), C-36 (Plumbing Contractor)	APPROVED	06/01/2022	06/01/2023
John S. Bascom Inc. dba Precision Plumbing-Mechanical	John Bascom	5350 Gabbert Rd., Moorpark, CA, 93021	805-529-4748	805-529-5433	india@pppmail.com	533836_	C-36 (Plumbing Contractor), C-4 (Boiler, Hot Water Heating and Steam Fitting Contractor)	APPROVED	06/01/2022	06/01/2023

Company	Name	Address	Phone	Fax	Email	License Number	License Classifications	Status	Status Date	Expires
K & Z CABINET CO., INC.	DENNIS CHAN	1450 S Grove Avenue, ONTARIO, CA, 91761	909-947-3567	909-947-3264	mrsangco@kzcbat.com	319196_	C-6 (Cabinet, Millwork and Finish Carpentry Contractor)	APPROVED	06/17/2022	06/17/2023
K.F.Y. UNITED MECHANICAL CONTRACTORS, INC. dba UNITED MECHANICAL CONTRACTORS	JEREMY YABLON	794 E. LOS ANGELES AVE., SIMI VALLEY, CA 93065	805-583-1010 x114	805-582-1126	jeremy@umcontractors.com	759496_	B (General Building Contractor), C-20 (Warm-Air Heating, Ventilating and Air-Conditioning Contractor)	APPROVED	06/01/2022	06/01/2023
KITCOR CORPORATION	Ruby Soriano	9959 Glenoaks Blvd, Sun Valley, CA, 91352	818-767-4800 x15	818-767-4658	ruby@kitcor.com	244236_	C-43 (Sheet Metal Contractor)	APPROVED	06/01/2022	06/01/2023
Kamran and Company, Inc.	Anja Nacitigall	415 n Salsipuedes St Santa Barbara, CA 93103	805-963-3016 x120	805-962-5915	anja@kamranco.com	687988_	C-38 (Refrigeration Contractor), B (General Building Contractor), C-61 (Limited Specialty)	APPROVED	06/17/2022	06/17/2023
Kemcorp Construction, Inc.	Melissa Reynolds	2060 E. Locust Street, Unit G, Ontario, CA, 91761	909-947-0639	909-947-0624	melissa@kemcorp.net	934522_	B (General Building Contractor), A (General Engineering Contractor)	APPROVED	06/17/2022	06/17/2023
Lee and Stires, Inc.	Katrina Richardson	634 S. Palmetto Ave, Ontario, CA, 91762	909-983-9557	909-983-1351	katrinar@lee-stires.com	288402_	A (General Engineering Contractor), C-12 (Earthwork and Paving Contractors)	APPROVED	06/01/2022	06/01/2023
Los Angeles Engineering, Inc.	Joseph Haygood	633 N. Barranca Ave, Covina, CA, 91723	626-454-5222 x208	626-454-5226	joseph@laeng.net	591176_	A (General Engineering Contractor), B (General Building Contractor), C-10 (Electrical Contractor), C-27 (Landscaping Contractor), HAZ (Hazardous Substance Removal Certification), C-61 (Limited Specialty)	APPROVED	06/16/2022	06/16/2023
Luna's Plumbing Inc.	Carlos Luna	1485 Spruce St, Unit G, Riverside, CA, 92507	951-364-6179	909-781-5457	carlos@lunasplumbinginc.com	893222_	C-36 (Plumbing Contractor)	APPROVED	06/16/2022	06/16/2023
Marina Landscape, Inc.	Hue Ta	3707 W Garden Grove Blvd, Orange, CA, 92868	714-939-6600 x485	714-935-1199	estimator@marinaco.com	492862_	A (General Engineering Contractor), B (General Building Contractor), C-27 (Landscaping Contractor), C-36 (Plumbing Contractor), C-61 (Limited Specialty), C-29 (Masonry Contractor)	APPROVED	06/01/2022	06/01/2023
McClanahan Inc DBA Hartmanaire	Cindy McClanahan	12 Gardenia, Lake forest, CA, 92630	951-479-6855	949-251-1101	balanceandtest@aol.com	1017713	C-61 (Limited Specialty)	APPROVED	06/01/2022	06/01/2023

Company	Name	Address	Phone	Fax	Email	License Number	License Classifications	Status	Status Date	Expires
McLeod Construction Inc	Charles McLeod	509 Burnham Road, Oak View, CA, 93022	805-377-0796		ojacontractor@gmail.com	1051880	B (General Building Contractor)	APPROVED	06/16/2022	06/16/2023
Oilfield Electric Company dba Oilfield Electric & Motor	Alan Fletcher	1801 N Ventura Ave, Ventura, CA, 93001	805-648-3131	805-648-4806	info@oilfld.com	125250_	C-10 (Electrical Contractor)	APPROVED	06/16/2022	06/16/2023
Pacific Coast Sound and Communications, Inc. dba Pacificcom	Hope Sanderson	330 N. Wood Road, Suite L, Camarillo, CA, 93010	805-987-1351	805-987-1353	hope@pacificomusa.com	529914_	C-7 (Low Voltage Systems Contractor)	APPROVED	06/01/2022	06/01/2023
Pathway Communications LTD	Becky Thurmon	12740 Danielson Court, Suite E, Poway, CA, 92064	858-324-1036	858-430-9459	beckyt@pcomus.com	868539_	C-7 (Low Voltage Systems Contractor)	APPROVED	06/16/2022	06/16/2023
Penn Air Control Inc	Marissa Ramirez	5941 LAKESHORE DR, CYPRESS, CA, 90630	714-220-9091	714-784-7296	marissa@pennairgroup.com	348326_	C-20 (Warm-Air-Heating, Ventilating and Air-Conditioning Contractor)	APPROVED	06/16/2022	06/16/2023
Pierre Landscape, Inc.	Steve Andrews	5455 2nd Street, Irwindale, CA, 91706	626-587-2121	626-513-2220	bids@pierrelandscape.com	638989_	A (General Engineering Contractor), C-27 (Landscape Contractor)	APPROVED	06/16/2022	06/16/2023
Preferred Ceilings, Inc.	Megan Arlow	475 CAPRICORN STREET, Brea, CA, 92821	714-255-9336	714-255-9165	megan@preferredceilings.com	705630_	C-2 (Insulation and Acoustical Contractor), B (General Building Contractor), C-10 (Electrical Contractor), A (General Engineering Contractor), C-61 (Limited Specialty)	APPROVED	06/16/2022	06/16/2023
Pro-Craft Construction, Inc.	Jessica Reed	500 Iowa Street, Redlands, CA, 92373	909-790-5222	909-797-2812	jreed@procraftci.com	467234_	A (General Engineering Contractor), B (General Building Contractor), C-2 (Insulation and Acoustical Contractor), C-16 (Fire Protection Contractor), C-34 (Pipeline Contractor), C-36 (Plumbing Contractor), C-42 (Sanitation System Contractor)	APPROVED	06/16/2022	06/16/2023
RCM Fire Protection Inc.	Deborah Stoffel	350 Enterprise Place, Tracy, CA, 95304	209-833-8228	209-833-8221	dstoffel@rcmfire.com	793205_	C-16 (Fire Protection Contractor)	APPROVED	06/16/2022	06/16/2023
RDM Electric Co., Inc.	Maria De Leon	4260 E. Brickell Street, Ontario, CA, 91761	909-591-0990	909-591-1599	m.deleon@rdmcompanies.com	539194_	C-10 (Electrical Contractor)	APPROVED	06/01/2022	06/01/2023

Company	Name	Address	Phone	Fax	Email	License Number	License Classifications	Status	Status Date	Expires
RND Contractors Inc	Jesse Dunn	14796 Jurupa Ave #A, Fontana, CA, 92337	909-429-8500 x116	909-429-8200	nsauter@rmdcontractorsinc.com	898471_	A (General Engineering Contractor), C-51 (Structural Steel Contractor)	APPROVED	06/01/2022	06/01/2023
Reed Mechanical Systems, Inc.	Tom Reed	4300 N Ventura Ave, Ventura, CA, 93001	805-768-6824 x102	805-768-6825	tomr@reedmechsys.com	957662_	C-20 (Warm-Air Heating, Ventilating and Air-Conditioning Contractor), B (General Building Contractor)	APPROVED	06/01/2022	06/01/2023
Russell Sigler Inc.	Jeffrey Myers	205 South Puente St., Brea, CA, 92821	714-421-2455		jmyers@siglers.com	960159_	C-20 (Warm-Air Heating, Ventilating and Air-Conditioning Contractor)	APPROVED	06/16/2022	06/16/2023
SBS Corporation	David Alatorre	2409 Avenida Del La Rosa, Camarillo, CA, 93012	805-494-4363 x405	805-494-4340	dalatorre@sbscorp.us	742782_	B (General Building Contractor)	APPROVED	06/13/2022	06/13/2023
Santa Maria Electric, Inc.	Steve Mussell	408 North Broadway, Santa Maria, CA, 93454	805-922-7777	805-925-5639	admin@smelectric.net	277342_	C-10 (Electrical Contractor), B (General Building Contractor)	APPROVED	06/16/2022	06/16/2023
Simco Mechanical, Inc.	Pascal Halajian	2222 Foothill Blvd, #E119, La Canada, CA, 91011	818-957-4994	818-957-4804	pascal@simcomechanical.com	974288_	C-20 (Warm-Air Heating, Ventilating and Air-Conditioning Contractor)	APPROVED	06/13/2022	06/13/2023
Smith Mechanical-Electrical-Plumbing	Koren Cloud	1340 W. Betteravia Road, Santa Maria, CA, 93455	805-621-5000	805-621-5050	kcloud@smithmap.com	420418_	A (General Engineering Contractor), B (General Building Contractor), C-2 (Insulation and Acoustical Contractor), C-4 (Boiler, Hot Water Heating and Steam Fitting Contractor), C-7 (Low Voltage Systems Contractor), C-9 (Drywall Contractor), C-10 (Electrical Contractor), C-16 (Fire Protection Contractor), C-20 (Warm-Air Heating, Ventilating and Air-Conditioning Contractor), C-36 (Plumbing Contractor), C-43 (Sheet Metal Contractor)	APPROVED	06/13/2022	06/13/2023
Southern Bleacher Company, Inc.	Carla Herndon	PO Box One Graham TX 76450	940-549-0733	940-549-1365	herndon@southernbleacher.com	564497_	A (General Engineering Contractor)	APPROVED	06/13/2022	06/13/2023
Standard Drywall, Inc.	Angie Peckman	9902 Channel Road, Lakeside, CA 92040	619-443-7034	619-443-7065	apeckman@standarddrywall.com	444328_	B (General Building Contractor), C-2 (Insulation and Acoustical Contractor), C-9 (Drywall Contractor), C-35 (Lathing and Plastering Contractor)	APPROVED	06/13/2022	06/13/2023

Company	Name	Address	Phone	Fax	Email	License Number	License Classifications	Status	Status Date	Expires
Star Hardware Inc.	Alan Cordero	201 N. Ponderosa Ave, Ontario, CA, 91761	909-481-7331	909-481-7241	cordero.alan@gmail.com	766703_	C-61 (Limited Specialty)	APPROVED	06/13/2022	06/13/2023
TELENET VoIP, INC.	EMIMELINE ADIZON	850 PARKVIEW DRIVE NORTH, EL SEGUNDO, CA, 90245	310-253-9000	310-253-9800	emmeline@telenetvoip.com	647808_	C-7 (Low Voltage Systems Contractor), C-10 (Electrical Contractor), C-16 (Fire Protection Contractor), C-61 (Limited Specialty)	APPROVED	06/13/2022	06/13/2023
Taft Electric Company	Travis Roy	1694 Eastman Avenue, Ventura, CA, 93003	805-642-0121	805-650-9015	troy@taftelectric.com	772245_	C-10 (Electrical Contractor), A (General Engineering Contractor), B (General Building Contractor), C-7 (Low Voltage Systems Contractor)	APPROVED	06/13/2022	06/13/2023
Tech-Time Communications Inc	Bryan Corsi	5801 Norris Road, Bakersfield, CA, 93308	661-397-0792	661-392-9676	Bryan.Corsi@TechTimeComm.com	750569_	C-7 (Low Voltage Systems Contractor), C-10 (Electrical Contractor)	APPROVED	05/27/2022	05/27/2023
The Groundskeeper, Inc	Harry Avedissian	P.O. Box 3402, Camarillo, CA, 93011	805-620-0995		tana@groundskeepervc.com	729273_	C-27 (Landscaping Contractor)	APPROVED	06/13/2022	06/13/2023
VLA Construction Inc	Veronique Loizu	22815 Ventura Blvd. #157, Woodland Hills, CA, 91364	818-225-1800	818-225-8112	vlainc@hotmail.com	1040399	B (General Building Contractor), C-33 (Painting and Decorating Contractor)	APPROVED	06/13/2022	06/13/2023
Venco Electric Inc.	Roy Martin	2360 Sturgis Road, Suite D, Oxnard, CA, 93030	805-278-1922	805-278-1959	vencoelectric@yahoo.com	446770_	C-10 (Electrical Contractor)	APPROVED	06/13/2022	06/13/2023
Waisman Construction, Inc.	Guy Waisman	21430 Strathern St., Unit D, Canoga park, CA, 91304	818-716-6396	818-716-6397	estimating@waiscon.com	839916_	B (General Building Contractor), C-2 (Insulation and Acoustical Contractor), C-10 (Electrical Contractor)	APPROVED	06/13/2022	06/13/2023
Western State Builders Inc	Julian Moen	2141 Orange Ave, Escondido, CA, 92029	760-270-8639	000-000-0__	julian@westernstatebuilder.com	1069677	A (General Engineering Contractor), C-61 (Limited Specialty), B (General Building Contractor)	APPROVED	06/09/2022	06/09/2023
Western States Roofing, Inc.	Lynne Reeves	18605 Parthenia, Northridge, CA, 91406	818-718-0770	818-718-1240	lynn@westernstatesroofing.com	993251_	C-39 (Roofing Contractor)	APPROVED	06/09/2022	06/09/2023

9.13



Agenda Item Details

Meeting	Jun 29, 2022 - RSD Regular Board Meeting
Category	9. Consent
Subject	9.13 Approval of the 2022/2023 contract renewal with FoodCorps Service for the fourth year.
Access	Public
Type	Action (Consent)
Fiscal Impact	Yes
Dollar Amount	30,000.00
Budgeted	Yes
Budget Source	LCAP
Recommended Action	It is recommended that the Board approve the FoodCorp. Service Contract for the fourth year. This agreement is to host 2 FoodCorps service members for the 2022-2023 school year. FoodCorps is a division of AmeriCorps, who's mission is to work with communities to connect kids to healthy food in school.

Public Content

Speaker:

Wael Saleh, Assistant Superintendent, Business Services, Oscar Hernandez, Assistant Superintendent of Educational Services and Lacey Piper, Director of Child Nutrition

Rationale:

The Rio School District is honored to be selected to host three FoodCorps Service members for the 2022/2023 school year.

FoodCorps is a division of AmeriCorps, who's mission is to work with communities to connect kids to healthy food in school. They partner with school districts, schools, and community organizations who play a critical role in fulfilling their mission and directly support service members in implementing high quality programming. Funding for 33 Nutrition Educators and 3 District Pilot Positions were given by the State of California for the 22/23 school year.

- Two Nutrition Educators- 40 hours per week, a service member will provide Rio Students with hands-on lessons based in nutrition, garden and culinary education at two Rio schools: Rio Del Sol, Rio Plaza, Rio Lindo, Rio Del Norte
- One service member for a District Pilot Position- 40 hours per week, a service member will support Rio's effort to increase local procurement by 10-15%, help with recipe development and student driven menus, support California Thursday initiatives, implement waste management programs, support and develop recipes for Rio's bakery, and support the districts wellness policy.

Service Fee - \$30,000.00

Rio PY23 Service Site Agreement - CA - Google Docs.pdf (206 KB)

Administrative Content**Executive Content**

Our adopted rules of Parliamentary Procedure, Robert's Rules, provide for a consent agenda listing several items for approval of the Board by a single motion. Most of the items listed under the consent agenda have gone through Board subcommittee review and recommendation. Documentation concerning these items has been provided to all Board members and the public in advance to assure an extensive and thorough review. Items may be removed from the consent agenda at the request of any board member.



FoodCorps Service Site Agreement

This Service Site Agreement (the "Agreement") is entered into by and between **FoodCorps, Inc.**, a 501(c)(3) New York not-for-profit corporation, FEIN: 27-3990987 ("FoodCorps") and **Rio School District** ("Service Site"), which is a [ENTITY TYPE] in the state of **California**, Tax ID: **95-600-2550**.

RECITALS

- A. FoodCorps partners with schools and communities to nourish kids' health, education, and sense of belonging so that every child, in every school, experiences the joy and power of food. FoodCorps AmeriCorps members serve alongside educators and school nutrition leaders for a year of service to provide kids with nourishing meals, food education, and culturally affirming experiences with food that celebrate and nurture the whole child.
- B. Service Site is a School District that desires to partner with FoodCorps in California (the "FoodCorps State") by facilitating FoodCorps programming in the FoodCorps State.

Accordingly, in consideration of the foregoing premises and the mutual covenants and obligations contained herein, the sufficiency of which is hereby acknowledged, the parties to this Agreement hereby agree as follows:

1. Purpose of Agreement

The purpose of this Agreement is to set forth the basic provisions, guidelines, and expectations for the relationship between Service Site and FoodCorps. These provisions, guidelines and expectations are designed to ensure full coordination between Service Site and FoodCorps. In the case of any legal dispute, this document along with all exhibits and documents referenced herein will serve as the sole binding agreement governing the terms of the relationship between Service Site and FoodCorps.

2. Definitions

The definitions in **Exhibit A** are included for reference and are incorporated by reference into this Agreement.

3. Service Site Requirements. Service Site Requirements are outlined in **Exhibit B**, which is incorporated by this reference into this Agreement. Service Site further agrees as follows:

3.1 Service Site agrees to comply, or use commercially reasonable efforts to ensure compliance, with the following:

- 3.1.1 FoodCorps Requirements, Policies and Procedures the terms of which are incorporated by reference into this Agreement, and within the FoodCorps

Handbook. Service Site supervisors will receive access to the FoodCorps Handbook during their supervisor training.

3.1.2 Prohibited Activities Rules. Service Site understands that the FoodCorps Handbook outlines the rules that prohibit the Service Site and Service Members from engaging in certain activities (as amended, modified or supplemented from time to time, collectively the "Prohibited Activities Rules"). The Prohibited Activities Rules may be modified from time to time by AmeriCorps or FoodCorps in writing (including by email). The Prohibited Activities Rules are incorporated by reference into this Agreement. Service Site agrees that it has reviewed, understands and agrees to comply with the Prohibited Activities Rules, and to use commercially reasonable efforts to ensure that Service Members understand and comply with the Prohibited Activities Rules.

3.1.3 Nondisplacement in Hiring. In conjunction with the Service Site Requirements, Service Site agrees that it will comply with the federal regulations prohibiting duplication or displacement set forth in 45 CFR §§ 2540.100(e)-(f), which generally provide that Service Site shall not displace an employee, position, or volunteer (other than a Service Member or another participant under the national service laws), including partial displacement such as reduction in hours, wages, or employment benefits, as a result of Service Site's participation in the FoodCorps Program or Service Site's utilization of any Service Member.

3.2 Program Service Fee. Service Site agrees to comply with the following regarding the Program Service Fee:

3.2.1 Unless otherwise agreed to in a writing signed or confirmed by both parties, Service Site must pay FoodCorps the Program Service Fee within 30 days of receipt of the invoice. FoodCorps will send Service Site its invoice in September.

3.2.2 No part of a Program Service Fee may be raised by or through the service of a Service Member.

3.2.3 Should a Service Member exit Service Term prior to End Date outlined in Exhibit A, due to either compelling circumstance (as outlined in the FoodCorps Handbook) or termination of this Agreement in accordance with the terms of this Agreement, a portion of the Program Service Fee may be refunded according to policy outlined in the FoodCorps Handbook.

3.3 School Memorandum of Understanding. If Service Site is a school district or community based organization, then Exhibit C must be signed by an authorized representative from each school served. If Service Site is an individual school, the School MOU is included in the Agreement and does not need to be signed separately.

3.4 Additional Service Site Obligations. Service Site further agrees as follows:

3.4.1 Service Site shall not make any offer or promise relating to an existing or potential service member's compensation or benefits.

3.4.2 Service Site shall not employ, recommend for employment, or otherwise facilitate the employment of Service Members for any commitment that would interfere with their full-time service, or prior to 60 days from the end of the Service Term, as defined in their respective Service Member contracts and in the FoodCorps Handbook.

- 3.4.3 Service Site must provide or ensure, as applicable, a safe and accessible work space for Service Members including consistent access to a computer, phone, printing and general office supplies, and storage space for program materials. This also includes making every reasonable effort to ensure that the health and safety of Service Members are protected during the performance of their assigned duties. Service Site may not assign or require Service Members to perform duties that would jeopardize their safety or cause them to sustain injuries.
- 3.4.4 Service Site agrees to complete the Partnership Planning Process (as defined in Exhibit A) in collaboration with FoodCorps to document their long term goals, their annual plan for programming, and the progress monitoring tool prior to the Start Date outlined in Exhibit A.
- 3.4.5 Service Sites will ensure that Service Members are properly and fully oriented to any and all of their service environments, which includes being trained on any and all laws, rules, policies, or procedures that may be applicable to the Service Member in that environment. Please refer to the Site, School, and Food and Nutrition Services Orientation Checklists in the FoodCorps Handbook. Service Site will also review the Partnership Plan (as defined in Exhibit A) with the Service Member within the first quarter of the Service Term.
- 3.4.6 Service Site agrees to properly supervise, control, and safeguard its premises, processes, or systems. To that end, Service Site agrees that it will not permit Service Members to operate any vehicle or mobile equipment, or entrust them with unattended premises, cash, checks, keys, credit cards, merchandise, confidential or trade secret information, negotiable instruments, or other valuables, which are not directly related to or necessary for their service.
- 3.4.7 Service Site agrees to immediately notify FoodCorps of matters that may seriously impact the experience or service environment of the Service Members, including but not limited to:
 - i. Any unusual incident, occurrence or event that involves the Service Site staff, volunteers or officers, or the FoodCorps Service Member, including but not limited to, the death or serious injury of any Service Site staff or Service Member; the arrest of any Service Site staff or Service Member; possible criminal activity on the part of any Service Site staff or Service Member; destruction of property by any Service Site staff or Service Member; significant damage to the physical facilities of the Service Site; or other matters of a similarly serious nature; and
 - ii. Any circumstance in which the member will not report to their school or service site for more than five regularly scheduled service days. This includes illness, injury, or requests for time off or teleservice.
 - iii. Service Site personnel changes that result in a new staff member being appointed as Service Site Supervisor.

4. Mutual Understandings. For the avoidance of doubt, the parties acknowledge and agree

as follows:

- 4.1 Service Site is only authorized to administer the Program in the FoodCorps State. This Agreement does not authorize Service Site to facilitate the Program in any other state, nor does this Agreement provide any indication or assurance of any preference on behalf of FoodCorps to offer the Program in any state other than the FoodCorps State, through Service Site or otherwise.
- 4.2 FoodCorps is the sole owner of, and retains all rights in and to, the Program and any and all intellectual property of FoodCorps. Service Site's administration of the Program within the FoodCorps State confers no rights onto Service Site with respect to the Program or FoodCorps's intellectual property other than those expressly granted in this Agreement.
- 4.3 FoodCorps's ability to operate the Program, and its ability to provide Service Members to serve in the FoodCorps State, is dependent on the levels at which AmeriCorps funds FoodCorps as an AmeriCorps program and continues FoodCorps's corresponding grant, and on FoodCorps's receipt of funding from sources other than AmeriCorps. Service Site acknowledges that receipt by FoodCorps of such funding is outside of FoodCorps's control, and that such funding may affect the number or placement of Service Members within the FoodCorps State. Service Site understands and agrees that FoodCorps does not guarantee (a) placement of any particular number of Service Members regardless of targets or (b) replacement of Service Members who are suspended or terminated or who resign.
- 4.4 Service Site may conduct fundraising activities to support the Service Member Program Service Fee and costs associated with local Program implementation (garden construction, curriculum materials, supervisor time, etc). Prior to commencing any fundraising activities related to the Program Service Fee in which Service Site intends to raise \$1,000 or more, Service Site must notify FoodCorps in advance of launching such fundraising activities.
- 4.5 FoodCorps welcomes advice and suggestions from Service Site, but FoodCorps has no obligation to modify the Program to incorporate any such advice or suggestions. FoodCorps is the sole owner of the Program, including its fundamental operating structure at the national, state, and local level.

5. Term; Termination; Effect of Termination.

- 5.1 Term. The effective date of this Agreement is the last date on which it is signed by all parties. This Agreement shall remain in effect unless it is terminated, as provided below, or until it expires. The expiration date of this Agreement shall be latter of (a) the term End Date; or (b) the date on which all Service Members serving in the FoodCorps State complete their Terms of Service (the "Completion Date"); provided, however, that FoodCorps and Service Site may mutually agree on an earlier Completion Date in the event that a particular Service Member's Term of Service is exceptionally long as a result of the suspension of their Term of Service for compelling circumstances (as that term is defined in the FoodCorps Handbook).
- 5.2 Extension of Term. In the event any one or more Service Members under the Service Site's direction do not complete their required number of service hours (as specified in the Service Member Contract) by the term End Date, this Agreement shall remain in effect until all Service Members have completed their required number of service hours

or have formally withdrawn or been released from the program.

- 5.3 **Mutual Agreement.** Service Site and FoodCorps may terminate this Agreement and all of their respective obligations hereunder at any time by mutual agreement in a writing signed by both parties.
- 5.4 **Material Breach.** Either party may terminate this Agreement for cause with immediate effect if the other party does not fulfill an obligation under this Agreement or if the other party violates any term or condition of this Agreement and such failure or violation is not cured, if curable, within 30 days after delivery of written notice of such failure or violation.
- 5.5 **Service Site Breach.** If Service Site violates the terms of this Agreement or undertakes an action or course of conduct that FoodCorps reasonably determines is in contravention or violation of the FoodCorps mission, objectives or goals, or violates federal, state or local law (a "violation"), then FoodCorps will put Service Site on notice of such violation and Service Site agrees to work diligently to reconcile the violation. Should Service Site fail to cure the violation within seven (7) days of receiving notice from FoodCorps, or if FoodCorps reasonably determines that the violation is extremely grievous, or that multiple violations have occurred, FoodCorps retains the right to immediately terminate this Agreement without liability.
- 5.6 **Effect of Termination.** Upon expiration or earlier termination of this Agreement, Service Site's rights under this Agreement to use the Program will terminate and the parties will be relieved of their respective further obligations under this Agreement except the rights and obligations under this Agreement that expressly survive termination or expiration.
- 5.7 The parties understand and agree that expiration or termination of this Agreement shall likewise terminate all rights of Service Site under this Agreement, including any rights to use FoodCorps intellectual property or to otherwise associate with the Program, and shall extinguish any obligations of FoodCorps to Service Site

6. Recordkeeping and Reporting

- 6.1 Service Site will maintain complete and accurate books, records, documents and other evidence related to this Agreement, the Program, Program fees, and Service Members ("Records"). Service Site will retain all Records for a period of not less than seven years following the termination or expiration of this Agreement or as otherwise required by applicable law and regulations. Service Site will make available all Records to FoodCorps and AmeriCorps for review, inspection, or audit upon written request during the term of this Agreement and for seven years after the expiration or termination of this Agreement.
- 6.2 Service Site will respond to and submit required programmatic reports to FoodCorps within the time frames specified by FoodCorps.

7. Independent Contractors

- 7.1 The parties agree that their relationship with respect to one another is that of independent contractors, and that neither party is an employee, partner, agent or in a joint venture with the other. All employees of FoodCorps shall be employees of FoodCorps and not of Service Site; and all employees of Service Site are and shall be employees of Service Site

and not FoodCorps. Each party acknowledges and agrees that it has no legal responsibility to withhold state or federal income tax, unemployment compensation, Social Security, or to provide any form or manner or pension or other fringe benefits for the other party's employees; and, each party is solely responsible for compensating its own employees, agents or representatives employed, or engaged, by it to perform duties under this Agreement and for all taxes, duties and all charges of any governmental authority arising from its activities under this Agreement. Neither party shall have no right or authority to assume or undertake any obligation of any kind, expressed or implied on behalf of the other party or to bind the other party in any way. The parties acknowledge that nothing contained in this Agreement shall be deemed or construed to constitute or create between the parties, a partnership, joint venture or agency. Neither party shall have the right or authority to assume or undertake any obligation of any kind, express or implied, on behalf of the other party or to bind the other party in any way, or to undertake any obligation of any kind, express or implied, on behalf of FoodCorps.

8. Background Checks

8.1 FoodCorps provides background checks for all Service Members that include: a check of the National Sex Offender Public Website; criminal history checks through True Screen for both the state of service and state of application; and FBI fingerprinting conducted by Fieldprint. All background check channelers are designated by AmeriCorps and require clearance prior to start of service.

Any additional background or health checks required of Service Members by the Service Site must be facilitated and paid for by the Service Site.

9. Confidential Information

9.1 "Confidential Information" means information in any form or medium (whether oral, written, electronic, or other) that a Disclosing Party (as defined in Section 9.2) considers confidential or proprietary. "Confidential Information" includes all information received by Service Site from FoodCorps related to this Agreement or the Program. "Confidential Information" does not include information that the Receiving Party (as defined in Section 9.2) can demonstrate by written or other documentary records: (i) was already known to the Receiving Party without restriction on use or disclosure prior to its receipt of or access to such information in connection with this Agreement; (ii) was or becomes generally known by the public other than by breach of this Agreement by, or other wrongful act of, the Receiving Party or any of its Representatives (as defined in Section 14(b)); (iii) was or is received by the Receiving Party from a third party who was not or is not, at the time of such receipt, under any obligation to the Disclosing Party to maintain the confidentiality of such information; or (iv) was or is independently developed by the Receiving Party without reference to or use of any of the Disclosing Party's Confidential Information.

9.2 In connection with this Agreement, each party (for purposes of this Section 9, the "Disclosing Party") may disclose or make available its Confidential Information to the other party (for purposes of this Section 9, the "Receiving Party"). As a condition to being provided with any disclosure of or access to the Disclosing Party's Confidential Information, the Receiving Party will:

- i. not use or permit to be used the Disclosing Party's Confidential Information other than as necessary to exercise its rights or perform its obligations under this Agreement.
- ii. protect and safeguard the confidentiality of all Confidential Information with at least the same degree of care as the Receiving Party would protect its own Confidential Information, but in no event with less than a commercially reasonable degree of care.

- iii. not disclose the Disclosing Party's Confidential Information except to its directors, officers, employees, consultants, or legal advisors ("Representatives") who: (a) have a need to know for the purposes of the Receiving Party's exercise of its rights or performance of its obligations under this Agreement; (b) have been informed of the confidential nature of the Confidential Information and the Receiving Party's obligations under this Section 9; and (iii) are bound by confidentiality and restricted use obligations at least as protective of the Confidential Information as the terms set forth in this Section 9.
 - iv. be responsible for ensuring its employees', consultants', and legal advisers' compliance with, and be liable for any breach by such individuals of this Section 8.
- 9.3 At the Disclosing Party's request, the Receiving Party shall return or destroy, as requested, the physical materials containing or relating to the Disclosing Party's Confidential Information, without retaining any copies. In the event of default under this Agreement by the Receiving Party, the Disclosing Party shall be entitled to seek injunctive relief in addition to any other remedies, including (without limitation) damages.
- 9.4 Each party's confidentiality obligations under this Section shall survive the expiration or termination of this Agreement for so long as such information received by the Receiving Party remains "Confidential Information."

10. Insurance; Limitation on Liability; Indemnification

10.1 Select *ONE* of the options for the 10.1 section of this Agreement.

Option A: Check to select

Service Site represents and warrants that it will maintain comprehensive general commercial liability insurance coverage, including insurance covering bodily injury liability and property damage, during the Term of this Agreement at a level that is reasonably sufficient to insure Service Site's operations and activities, including oversight of the FoodCorps Program. Service Site agrees that all such policies for liability protection, bodily injury or property damage shall cover any and all Service Members serving at the Service Site.

Option B: Check to select

Service Sites warrants that it will provide self-insurance, including insurance covering bodily injury liability and property damage, during the Term of this Agreement at a level that is reasonably sufficient to insure Service Site's operations and activities, including oversight of the FoodCorps Program.

10.2 Notwithstanding anything stated or implied to the contrary herein, in no event shall either party be liable to the other for exemplary, punitive, incidental or consequential damages, even if advised of the possibility of such damages, in any manner arising out of this Agreement or the breach of any term, covenant, representation, warranty or obligation contained herein.

10.3 To the extent permitted by any applicable statutes, Service Site agrees to indemnify,

defend and hold harmless FoodCorps and its officers, directors, employees, and members from and against any and all claims, actions, suits, demands, losses, damages, judgments, settlements, costs and expenses (including reasonable attorneys' fees and expenses), and liabilities of any kind (a "Claim"), which may arise by reason of (i) any act or omission by Service Site or any of its subsidiaries, affiliates, related entities, partners, officers, directors, employees, members, or agents; or (ii) the inaccuracy or breach of any of the covenants, representations and warranties made by Service Site in this Agreement. Service Site agrees to promptly notify FoodCorps upon receipt of any Claim. The provisions of this section shall survive any revocation, surrender or other termination of this Agreement.

11. General Provisions

- 11.1 Amendment: Waiver. This Agreement may be amended only in a writing clearly setting forth the amendment(s) and executed by both parties. Any waiver of a term or condition of this Agreement in one instance shall not be deemed to constitute a waiver in any other instance. A failure to enforce any provision of this Agreement shall not operate as a waiver of such provision or of any other provision hereof.
- 11.2 Severability. If any term, provision, covenant, or condition of this Agreement is held by a court of competent jurisdiction to be invalid, void or unenforceable, the remainder of the provisions shall remain in full force and effect and shall in no way be affected, impaired or invalidated.
- 11.3 Assignment. Neither this Agreement nor any other rights or obligations of a party under this Agreement may be assigned or delegated by either party.
- 11.4 No Third Party Beneficiaries. Nothing in this Agreement is intended or shall be construed to give any person, other than the parties hereto, their successors and permitted assigns, any legal or equitable right, remedy or claim under or in respect of this Agreement or any provision contained herein.
- 11.5 Warranties. Service Site represents and warrants that it is either a nonprofit organization or a public institution (e.g., a public hospital or state educational institution). Furthermore, each party covenants, warrants and represents that it shall comply with all laws, regulations and other legal standards applicable to this Agreement, or relevant to service and the service environment, including the Americans with Disabilities Act and laws prohibiting harassment and discrimination, and that it shall exercise due care and act in good faith at all times in performance of its obligations under this Agreement. The provisions of this Section shall survive any revocation, surrender or other termination of this Agreement.
- 11.6 Entire Agreement. This Agreement, including all Exhibits and any manuals, handbooks, guidelines and other documents incorporated by reference, constitutes the entire agreement of the parties with respect to the subject matter hereof and supersedes all prior and/or contemporaneous agreements and understandings, written or oral, between the parties with respect to the subject matter hereof.
- 11.7 Execution in Counterparts: Facsimile Signatures. This Agreement may be executed by the parties in counterparts, each of which when so executed and delivered shall be deemed to be an original and all of which when taken together shall constitute one and

the same agreement. This Agreement may be executed by any party by delivery of a facsimile signature, or email signature in PDF form, whose signature shall have the same force and effect as an original signature.

* * * *

IN WITNESS WHEREOF, the parties have caused this Agreement to be executed as of the last date written below by their duly authorized representatives.

SERVICE SITE:
Rio School District

FOODCORPS:
FoodCorps, Inc.

Signature _____

Signature _____

Print Name _____

Print Name _____

Title _____

Title _____

Date _____

Date _____

THE UNDERSIGNED **SERVICE SITE SUPERVISOR** HAS READ AND UNDERSTANDS THE FOREGOING AGREEMENT.

Signature _____

Print Name _____

Title _____

Date _____

9.14



Agenda Item Details

Meeting	Jun 29, 2022 - RSD Regular Board Meeting
Category	9. Consent
Subject	9.14 Approval of Amendment of Agreement to Child Nutrition Grocery Bid with SYSCO
Access	Public
Type	Action (Consent)
Budget Source	Child Nutrition
Recommended Action	Staff recommends approval of the Amendment of Agreement to Child Nutrition Grocery Bid with SYSCO

Public Content

Speaker:

Wael Saleh, Assistant Superintendent, Business Services/Lacey Piper, Director of Child Nutrition

Rationale:

SYSCO Ventura has had to adjust their pricing structure due to manufacturers pulling Force Majeure and increasing pricing to SYSCO. SYSCO will be moving forward to a fixed per case charge versus a fixed charge.

Fixed fee per case of \$3.25 on commercial items

Fixed fee per case of \$3.50 on USDA commodity items

At the time of notification, the district conducted a 20 item study to make sure there were no significant price increases at the time. Administration also worked with CDE to make sure this Contract Amendment is in Accordance with the law.

[RIO 20 lines compare \(2\) \(4\).xls \(52 KB\)](#)

[Notice of Rollover SYSCO 22-23 \(1\).pdf \(688 KB\)](#)

Administrative Content

Executive Content

Our adopted rules of Parliamentary Procedure, Robert's Rules, provide for a consent agenda listing several items for approval of the Board by a single motion. Most of the items listed under the consent agenda have gone through Board subcommittee review and recommendation. Documentation concerning these items has been provided to all Board members and the public in advance to assure an extensive and thorough review. Items may be removed from the consent agenda at the request of any board member.

						CURRENT PRI		
SUPC	Unit Sell	Gross Sell	Brand	Pack	Description	Landed Cost	Bid Discounts	Commercial Price
4102105	47.370	47.160	DELREAL	12/4 CT	Tamale Chicken In Green S	44.660	1.560	43.100
1804137	79.990	82.330	USDA	135/2.45OZ	Beef Patty Mesqt	79.830	7.040	72.790
3386273	46.630	47.320	POSADA	140/1.74OZ	Taquito Chkn Whl/grn	49.230	5.470	43.760
7000999	134.580	161.800	GLDKIST	6/5 LB	Chicken Brst Fil Whl Grn	159.300	35.830	123.470
2420350	128.510	122.500	GLDKIST	1/30 LB	Chicken Nugget Whl Grain	120.000	.340	119.660
4915577	45.700	45.700	TYSON	1/15 LB	Chicken 8pc Brd Pck			
1649553	67.480	63.850	LOSCABO	96/5.2 OZ	Burrito Bean & Chdr	61.350	.000	61.350
933640	69.900	66.100	JENNIEO	4/5 LB	Turkey Ground Raw Thigh C	63.600	.000	63.600
8617316	47.270	53.260	KRSTEAZ	9/24 CT	Waffle Blgn Stk Whl Grn .	50.760	1.030	49.730
1917145	44.370	44.370	ADVANCE	72/2.8 OZ	Sandwich Peanut Btr Stwbr			
8304593	33.900	34.680	SUPBKRY	72/2.9OZ	Bun Cinnamon Bkd Whl Whea	32.180	.000	32.180
4069720	26.600	33.860	NAT VLY	4/36 CT	Snack Bar Granola Oats N	31.360	7.160	24.200
3544228			Invalid Item					
139610	33.130	42.650	PILLSBY	72/2.29OZ	Roll Cinn Mini Cinni	37.820	7.640	30.180
2344287	48.350	48.350	LOSCABO	72/2.5 OZ	Burrito Bkfst Egg Turkey/			
2314308	146.460	139.030	LINGS	6/5 LB	Chicken Whl Grn Mndrn Orn	136.530	.000	136.530
2173365	28.030	46.300	PILLSBY	72/2.47OZ	Waffle Maple Madness Mini	41.470	14.010	27.460
4909174			Invalid Item					
3116754	65.220	61.700	JENNIEO	4/5LB	Frank Turkey 8/lb	59.200	.000	59.200
7270881	54.360	58.610	GOLDMDL	6/5 LB	Mix Muffin Whl Grain Comp			
2464704	70.160	72.000	SUNWSFD	96/2.8 OZ	Sandwich Sunflower Btr/je	69.500	5.660	63.840
2223465	40.430	42.410	SMUCKER	72/2.6OZ	Sandwich Peanut Btr&stw W	39.910	3.590	36.320
7057341	42.010	40.700	LOSCABO	72/2.5 OZ	Burrito Bkfst Egg/chs/sau	38.200	.000	38.200
7002671	39.020	38.000	BUENVST	96/2 OZ	Brownie Choc Wg Low Fat I	35.500	.000	35.500
1745227	37.370	37.540	FAT CAT	2/9 LB	Batter Muffin Cornbread W	35.040	1.040	34.000

BIDDING METHOD			COST PLUS METHOD			
Commercial Price to Rio	NOI	Final Price to Rio	Fixed Markup	Commercial Price to Rio	NOI	Final Price to Rio
47.370			3.25	46.35		
79.990			3.25	76.04		
46.630			3.25	47.01		
134.580	22.95	111.63	3.5	126.97	22.95	104.02
128.510			3.25	122.91		
45.700				45.70		
67.480			3.25	64.60		
69.900			3.25	66.85		
47.270			3.25	52.98		
44.370				44.37		
33.900			3.25	35.43		
26.600			3.25	27.45		
33.130			3.25	33.43		
48.350				48.35		
146.460			3.25	139.78		
28.030			3.25	30.71		
65.220			3.25	62.45		
54.360				54.36		
70.160			3.25	67.09		
37.530			3.25	39.57		
42.010			3.25	41.45		
39.020			3.25	38.75		
37.370			3.25	37.25		

NOTES	which method is less?
	Cost Plus
	Cost Plus
	Current method
USDA item, Cost Plus \$3.50	Cost Plus
	Cost Plus
Not on bid. No change	n/a
	Cost Plus
	Cost Plus
	Current method
Not on bid. No change	n/a
	Current method
	Current method
Invalid Item, not in Sysco Ventura's system	n/a
	Current method
Not on bid. No change	n/a
	Cost Plus
	Current method
Invalid Item, not in Sysco Ventura's system	n/a
	Cost Plus
Not on bid. No change	n/a
	Cost Plus
	Current method
	Cost Plus
	Cost Plus
	Cost Plus



Board of Trustees

Cassandra Bautista, President
Eleanor Torres, Clerk
Linda Armas
Edith Martinez Cortes
Kristine Anderson

John D. Puglisi, Ph.D., Superintendent

May 13th, 2022

Sysco Ventura, Inc.
3100 Sturgis Road
Oxnard, CA 93030

Re: Notice of Intent to Rollover Bid no.
20-CNS-002 Food and Grocery Products

AMENDMENT NO. 1 TO AGREEMENT WITH SYSCO VENTURA, INC

This Amendment No. 1 modifies the Rio School District previously awarded RFP 20-CNS-002. Except as modified by the following, all of the documents previously awarded remain unmodified and in full force and effect.

INVOICE PRICING

As outlined in Sysco's letter dated April 19, 2022, the COVID pandemic, worldwide logistic interruptions, and unprecedented inflation have forced Sysco to take a different approach to bid pricing for the upcoming school year.

Sysco is proposing a fixed price per case markup of:
\$3.25/case for items on the Commercial bid
\$3.50/case for items on the USDA Commodity bid

Sysco agrees to maintain records in order to support their proposed pricing:

Landed price to Sysco
LESS manufacturer deviation
PLUS fixed price per case
EQUALS Price to District

PRICE VERIFICATION

Unless otherwise required in order for District to comply with government regulation, District will be allowed two (2) annual price verifications at Sysco Ventura for purchases made under this Agreement. The price verification will consist of reviewing computer reports documenting Sysco's calculation of District's invoice price and verification of the Sysco's landed Cost. If requested, applicable Supplier

invoices and accompanying freight invoices will also be made available. Supplier invoices consist of invoices from third party suppliers or from Affiliates, SMS or a Specialty Company, as applicable. Price verification adjustments, if applicable, will be made utilizing the net of undercharges and overcharges to District. The price verification process is subject to the following:

- a. District must request a price verification in writing as least twenty (20) business days prior to the suggested date of the price verification and must identify not more than fifty (50) items to be price verified and the period covered;
- b. The date and time of price verification must be to the mutual agreement of District and the Sysco;
- c. The price verification will be made at Sysco Ventura;
- d. Support for the price verification may not be removed from Sysco Ventura's premises where the price verification is conducted;
- e. The period for which pricing is to be verified will not begin more than three (3) months prior to the date of the price verification, and will cover only one pricing period; and
- f. In no event will pricing be corrected for more than 6 months prior to the date of the price verification.

Sysco is mandated to comply with the Code of Federal Regulations as detailed below:

7 CFR 210.21 Procurement

(f) Cost reimbursable contracts

(1) Required provisions. The school food authority must include the following provisions in all cost reimbursable contracts, including contracts with cost reimbursable provisions, and in solicitation documents prepared to obtain offers for such contracts:

(ii)

(A) The contractor must separately identify for each cost submitted for payment to the school food authority the amount of that cost that is allowable (can be paid from the nonprofit school food service account) and the amount that is unallowable (cannot be paid from the nonprofit school food service account); or

(B) The contractor must exclude all unallowable costs from its billing documents and certify that only allowable costs are submitted for payment and records have been established that maintain the visibility of unallowable costs, including directly associated costs in a manner suitable for contract cost determination and verification;

When mutually agreeable to both the District and Sysco, with written agreement, this Amendment No. 1 may be abandoned in favor of a return to pricing as outlined in RFP 20-CNS-002.

Except as modified above, no other portion of RFP 20-CNS-002, is modified by this Amendment No. 1.

IN WITNESS WHEREOF, the parties have executed this Amendment No. 1 to RFP 20-CNS-002, as of the date written above.

Thank you,
Sincerely,

Lacey Piper MS, RD

Director of Child Nutrition

I agree to rollover the Rio School District Bid no. 20-CNS-002

Signature

Date

9.15



Agenda Item Details

Meeting	Jun 29, 2022 - RSD Regular Board Meeting
Category	9. Consent
Subject	9.15 Memorandum of Understanding with Oxnard Union High School District K12 Strong Workforce Program Grant Funds
Access	Public
Type	Action (Consent)
Fiscal Impact	No
Dollar Amount	58,589.00
Budgeted	No
Budget Source	Not applicable
Recommended Action	Staff recommends board approval of K12 Strong Workforce Program grant.

Public Content

Speaker: Oscar Hernandez, Assistant Superintendent Ed. Services

Rationale:

Rio School District is included in an Oxnard Union High School District grant work plan for K12 Strong Workforce Program (SWP) grant funds, round 4. Funding supports middle school career exploration. Provides funds of \$58,589.

K12 SWP Round 4 RFA.pdf (638 KB)

Administrative Content

Executive Content

Our adopted rules of Parliamentary Procedure, Robert's Rules, provide for a consent agenda listing several items for approval of the Board by a single motion. Most of the items listed under the consent agenda have gone through Board subcommittee review and recommendation. Documentation concerning these items has been provided to all Board members and the public in advance to assure an extensive and thorough review. Items may be removed from the consent agenda at the request of any board member.



California Community Colleges

Workforce and Economic Development Division

Request for Application

K12 STRONG WORKFORCE PROGRAM ROUND 4

Funding Year:	FY 2021-2022
RFA Release Date:	August 16, 2021
Questions Deadline:	Written questions about specifications in the Request for Application must be received by 5:00 pm on Friday, September 17, 2021, via email to: K12SWP@cccco.edu
Bidders' Conference:	Tuesday, August 24, 2021 1:00 pm – 2:30 pm PDT Registration for K12 SWP Bidder's Conference
Application Deadline:	Applications must be received by 5:00 pm on Friday, October 15, 2021, in NOVA

Administered by the
California Community Colleges Chancellor's
Office, Workforce and Economic
Development Division (WEDD),
1102 Q Street
Sacramento, CA 95814–5901



California Community Colleges

K12 STRONG WORKFORCE PROGRAM ROUND 4 Request for Application

California Community Colleges Chancellor's Office Workforce and Economic Development Division Table of Contents

SECTION I: GENERAL INFORMATION	5
A. BACKGROUND AND PURPOSE	5
B. OBJECTIVES AND FOUNDATIONAL PRINCIPLES	6
a) Objectives	6
b) Alignment with Strong Workforce Program Regional Plan.....	6
C. FUNDING	7
a) Regional Funding Distribution Based on Average Daily Attendance	7
b) Statewide Funding Allocations to the Regions	8
c) Awarded Funding Levels for LEAs	9
d) Subsequent Funding Requests in Future Cycles	9
e) K12 Selection Committee.....	9
D. ELIGIBILITY REQUIREMENTS	10
a) Eligible Applicants	10
b) Eligibility Requirements for Applicants	10
c) Adult Education Programs.....	11
E. POSITIVE CONSIDERATIONS	11
F. PARTNERSHIPS	12
a) Higher Education Partners	13
b) K-12 Partner Agencies	13
c) Collaborative Partners.....	13
G. MATCH REQUIREMENTS	14
a) Proportional Dollar Match.....	14
b) Acceptable and Unacceptable Financial Match Sources.....	14
H. APPLICATION DETAILS	15
a) Application Due Date	15



California Community Colleges

b) Application Review.....	15
c) Allowable and Non-Allowable Activities and Costs	16
d) Administrative Indirect Cost Rate	16
e) Incomplete and Late Applications	16
f) Performance Period	17
I. CALENDAR OF KEY DATES FOR K12 SWP GRANT CYCLE	17
J. TECHNICAL ASSISTANCE	17
K. RFA CLARIFICATION	18
L. APPEALS PROCESS	19
SECTION II: INSTRUCTIONS FOR PREPARING AND SUBMITTING THE K12 SWP APPLICATION.....	20
A. CREATING A NOVA ACCOUNT/ACCESSING YOUR NOVA ACCOUNT	20
B. NOVA TECHNICAL ASSISTANCE	20
C. SUBMITTING THE K12 SWP APPLICATION	20
D. APPLICATION FORMAT AND INSTRUCTIONS	20
E. DOWNLOADABLE APPLICATION TOOLS	30
APPENDIX A: GRANTEE REQUIREMENTS AND GUIDELINES.....	31
A. ALIGNMENT WITH GUIDING POLICY PRINCIPLES TO SUPPORT K-14+ PATHWAYS	31
B. LEVERAGING PARTNERSHIPS AND CTE FUNDING SOURCES	31
C. LEVERAGING MULTIPLE CTE FUNDING SOURCES	33
D. PROGRAM OUTCOME MEASURES	33
E. REPORTING REQUIREMENTS	34
a) Program Outcome Measures Reporting	34
b) Progress and Fiscal Reporting (see Table 9 for details)	34
APPENDIX B: Appendix Program-Specific Legal Terms, and Conditions	36
A. COST AND PAYMENTS	36
B. WORK TO BE PERFORMED	36
C. MODIFICATION/BUDGET CHANGES.....	36
D. ASSURANCES, CERTIFICATES, TERMS, AND CONDITIONS	37



California Community Colleges

APPENDIX C: GUIDELINES, DEFINITIONS, AND ALLOWABLE EXPENDITURES.....38
A. DETERMINING IF A COST IS ALLOWABLE.....38

LIST OF TABLES

Table 1. Regional Funding Distribution Based on Average Daily Attendance7
Table 2. 2021 K12 SWP Allocations8
Table 3. Awarded Funding Levels Based on ADA, 20219
Table 4. Acceptable and Unacceptable Financial Match Sources..... 15
Table 5. Calendar of Key Dates for K12 SWP Grant Cycle..... 17
Table 6. K14 Technical Assistance Providers 18
Table 7. Contact Information for Regional Chairs 19
Table 8. Application Sections21
Table 9. K12 SWP Progress and Expenditure Report Due Dates35
Table 10. Allowable and Non-Allowable Activities and Costs.....39



SECTION I: GENERAL INFORMATION

A. BACKGROUND AND PURPOSE

California's economic competitiveness is fueled, in part, by the strength of its regional economies and its skilled workforce. California is committed to investing in developing a skilled workforce to meet the state's labor market needs and to ensure upward social and economic mobility for Californians. In 2016, the California Legislature approved the Strong Workforce Program (SWP), budgeting an ongoing \$248 million for the state's community colleges to enhance and expand career technical education (CTE) and workforce training to prepare students for high-wage employment in industries that meet regional labor market needs.

Commencing with the 2018–19 fiscal year, an additional \$150 million was allocated on an annual and ongoing basis to K–12 local education agencies (LEAs) through the K12 Strong Workforce Program (K12 SWP) to create, support, and/or expand high-quality CTE at the K–12 level (Education Code, Section 88827).

The California Community Colleges Chancellor's Office (Chancellor's Office), in partnership with the California Department of Education (CDE), is seeking applications from eligible LEAs for K12 SWP funds to create, support, and/or expand high-quality CTE course sequences, programs, and pathways at the K–12 level that are aligned to regional workforce efforts occurring through the SWP.

The ultimate goal of Strong Workforce Program K12 grant funds is to support K–12 local education agencies (LEAs) in creating, improving, and expanding career technical education (CTE) courses, course sequences, programs of study, and pathways for students transitioning from secondary education to postsecondary education to living-wage employment.

California has experienced an unprecedented time battling a global pandemic with serious impacts to livelihood. More than one million Californians have filed new unemployment claims since the pandemic began sweeping across the country. As vaccinations roll out across the state, recovery is within reach. The COVID-19 pandemic has exposed the economic inequality that is deeply ingrained in our society, making it clear that we cannot return to business as usual. Similarly, California's community colleges are also faced with creating a new normal, with a clear "Call to Action" by the Chancellor's Office to help design and innovate for an equitable recovery and post-pandemic economy.

Inclusive economic development is about both process and outcome, mobilizing cross-sector collaboration and focusing on approaches to shared prosperity; the outcomes from such economic growth can be greater and more mutually beneficial to education, businesses, communities, and workers, including historically disproportionately impacted students.



California Community Colleges

B. OBJECTIVES AND FOUNDATIONAL PRINCIPLES

a) Objectives

The primary objectives of K12 SWP are the following:

- ❖ To support essential collaboration across education systems between the K–12 sector and community colleges—also known as intersegmental partnerships—with involvement from industry businesses and organizations in strengthening CTE courses, programs, and pathways aligned with regional workforce needs.
- ❖ To support LEAs in developing and implementing high-quality, K–14 CTE course sequences, programs, and pathways that:
 - Build foundational career path skills and knowledge essential to subsequent success in college and early career exploration.
 - Enable a seamless and successful transition from secondary to postsecondary education within the same or related career paths.
 - Lead to completion of industry-valued certificates, degrees, or transfers to community college or four-year University.
 - Prepare students upon completion of education to enter into employment in occupations for which there is documented demand that pay a livable wage.
 - Identify and close equity gaps by improving access to and completion of high-skill/high-wage CTE opportunities for disproportionately impacted students.
 - Facilitate K–12 student exploration and selection of learning opportunities leading to career paths.

b) Alignment with Strong Workforce Program Regional Plan

The K12 SWP legislation specifies that funds are provided to “create, support, or expand high-quality career technical education programs at the K–12 level that are aligned with the workforce development efforts occurring through the Strong Workforce Program” (Education Code, Section 88827). The workforce development efforts within each region are established by the Strong Workforce Program Regional Plan (“Regional Plan”). Developed under the guidance of each of the eight California Community College Regional Consortia (“Regional Consortia”), each Regional Plan, by design, is responsive to regional economic priorities. Similarly, applications for K12 SWP funds should be responsive to the regional priorities, labor market needs, and consortium goals as identified in the Regional Plan.

To remain current, all of the eight Regional Plans are revised every four years and updated annually through collaborations between the community colleges, K–12 LEAs, industry leaders, workforce development agencies, and other workforce development



California Community Colleges

stakeholders. The Regional Plan for each Regional Consortium are located at the following websites:

- ❖ [Bay Area – Strong Workforce Program Regional Plan](#)
- ❖ [Central/Mother Lode – Strong Workforce Program Regional Plan](#)
- ❖ [Inland Empire/Desert – Strong Workforce Program Regional Plan](#)
- ❖ [Los Angeles – Strong Workforce Program Regional Plan](#)
- ❖ [Orange County – Strong Workforce Program Regional Plan](#)
- ❖ [North/Far North – Strong Workforce Program Regional Plan](#)
- ❖ [San Diego/Imperial Counties – Strong Workforce Program Regional Plan](#)
- ❖ [South Central Coast – Strong Workforce Program Regional Plan](#)

C. FUNDING

a) Regional Funding Distribution Based on Average Daily Attendance (ADA)

Within each of the eight regions, funding distribution to the applicants is based on ADA as presented in Table 1 (Education Code, Section 88827(c)(2)).

Table 1. Regional Funding Distribution Based on Average Daily Attendance¹

Total Applicants' ADA	Percentage of a Region's Allocation
Less than or equal to 140	4%
141 – 550	8%
More than 550	88%

A K12 Selection Committee, in consultation with its Regional Consortium, has the discretion to adjust the percentages of a region's allocation, as needed. For example, if LEAs with less than 140 ADA account for substantially less than 4 percent of the region's total ADA, a portion of the 4 percent of funds allocated to that distribution level may be added to another level.

¹ Source: California Community Colleges Chancellor's Office and the California Department of Education, 2021.



California Community Colleges

b) Statewide Funding Allocations to the Regions

The California Legislature (Education Code, Section 88827(c)(1)(A-B)) appropriated statewide funding of \$150 million that is apportioned annually by the Chancellor’s Office to the fiscal agent of each of the eight Regional Consortia based on the following weighted factors in each region²:

- The unemployment rate. (33 percent of the allocation formula)
- The region’s total Average Daily Attendance (ADA) for pupils in grades 7 through 12, inclusive.¹ (33 percent of the allocation formula)
- The proportion of projected regional job openings. (34 percent of the allocation formula)

Table 2. 2021 K12 SWP Allocations

Regional Consortium	K12 SWP Allocation
Bay Area	\$30,825,442
Central Valley/Mother Lode	\$20,846,960
Inland Empire/Desert	\$18,048,425
Los Angeles	\$25,339,879
Orange County	\$11,789,491
North/Far North	\$19,844,596
San Diego/Imperial	\$13,318,371
South Central Coast	\$9,986,836
TOTAL	\$150,000,000

² Per Senate Bill 117, ADA changed for reporting for both 2019-20 P-2 and annual to include all full school months from July 1, 2019, to February 29, 2020, to mitigate the impact of COVID closures on ADA. For more information see CDE FAQ webpage at: <https://www.cde.ca.gov/fg/aa/pa/covidfaqs.asp>.



c) Awarded Funding Levels for LEAs

There are four funding levels of maximum allowable dollar amounts for each application based on total ADA of the grant-seeking LEAs as shown in Table 3.

Table 3. Awarded Funding Levels Based on ADA, 2021³

Total Average Daily Attendance of LEAs	Maximum allowable grant amount
Up to 140 ADA	Up to \$250,000
141 to 550 ADA	Up to \$500,000
551 to 10,000 ADA	Up to \$1,000,000
Over 10,000 ADA	Up to \$2,000,000

Total ADA is equal to the sum of all grant-seeking LEAs' ADA (inclusive of both Lead and K-12 Partner Agencies) that are participating in a given application, meaning that the LEAs' total ADA will be used to determine the maximum allowable funding level.

The funding levels in Table 3 indicate the maximum amount that can be requested in any one application. Applicants are allowed to request any level of funding for which they are eligible so long as it does not exceed the maximum level. **The regional K12 Selection Committee has discretion to award an amount less than the requested amount based on an applicant's work plan, budget, number of students and/or teachers served as well as based on the committee's responsibility to ensure a portfolio of awards that best meets the needs of the region's economy and the intention of the legislation.**

d) Subsequent Funding Requests in Future Cycles

Obtaining a K12 SWP grant in one round of funding does not prohibit LEAs from applying again in ensuing funding cycles. Subsequent funding requests are not intended to sustain programs, rather, are intended to create a new CTE program that feeds into a community college program; phase in, augment, or improve the sequence of courses or pathway; or to scale to a larger number of students of a previously funded K12 SWP project. Through this competitive grant process, applicants awarded a K12 SWP grant in one year are not guaranteed funding in a subsequent round of funding.

e) K12 Selection Committee

Each Regional Consortium has a K12 Selection Committee that is responsible for reviewing all LEA applications that are requesting K12 SWP funds within its region (Education Code, Section 88829). **The K12 Selection Committee makes all decisions within its region related to selecting grant recipients and awarding specific funding amounts for each grant.** Each Regional Consortium forms a K12 Selection

³ Source: California Community Colleges Chancellor's Office and the California Department of Education, 2021.



California Community Colleges

Committee made up of individuals with expertise in K–12 career technical education and workforce development.

D. ELIGIBILITY REQUIREMENTS

a) Eligible Applicants

Eligible K12 SWP applicants consist of one or more of any combination of the following LEAs:

- School district
- County office of education
- Charter school
- Regional occupational center or program (ROCP) operated by either a joint powers authority or by a county office of education, provided that the applicant has certified that all partners are aware of this grant and agree to submission.

LEAs are encouraged to partner with other LEAs as co-applicants, but one LEA must be identified as the Lead Agency (or fiscal agent) on each K12 SWP application. The other LEAs are K–12 Partner Agencies. **An LEA can submit no more than three K12 SWP applications as a Lead Agency or as a K–12 Partner Agency per funding cycle.**

b) Eligibility Requirements for Applicants

LEAs applying to receive a K12 SWP grant must comply with **all of** the following:

- (1) The LEA applicant must partner with at least one community college or community college district in their application. It is allowable and encouraged for LEAs to partner with multiple community colleges or community college districts. The partnership should be strongly demonstrated within the grant proposal. LEAs that have a substantial number of students being served by a college in another region may partner with a community college in that region, if the college or colleges agree to partner with the LEA. The LEA still applies for funds from the Regional Consortium in which the LEA or LEA site is principally located, not the Regional Consortium of the partnering community college or community college district.
- (2) The LEA (Lead and all K–12 Partner Agencies) shall be located within the geographical boundaries of the region from which it is applying for funds. LEAs that are located in multiple regions may apply in each region within which they have a site but are limited to submitting no more than three applications total as either a Lead or a K–12 Partner Agency. Any LEA that offers primarily online/virtual instruction may apply only in the region within which their district is located.
- (3) Per Education Code, Section 88828(b), each LEA that is a Lead or K–12 Partner Agency on the application will upload a completed High-Quality CTE Program Evaluation that reflects the current practice of existing CTE programs and related evidence on file. LEAs that have applied for CTEIG funds will upload the same



California Community Colleges

High-Quality CTE Program Evaluation used in the most recent CTEIG application. LEAs that did not apply for CTEIG funds will complete and upload a new Program Evaluation. **The Program Evaluation is not scored for the K12 SWP application, but rather used as a tool to inform planning.** By completing the High-Quality CTE Program Evaluation, an LEA identifies areas of improvement in its CTE programs and develops a plan for addressing target areas using the K12 SWP Work Plan. The K12 SWP funding is an opportunity to complement existing CTE plans and work or to create new CTE programs. Visit the [California Department of Education](#) website to download a copy of the High-Quality CTE Program Evaluation.

- (4) Each LEA that is a Lead or K–12 Partner Agency on the application must engage in regional efforts to align workforce, employment, and education services. In addition, each must use its region's Regional Plan to inform efforts to create, implement, or expand CTE courses, course sequences, programs, and pathways; and to the extent possible, integrate available local, regional, state, and private resources to improve the successful outcomes of pupils enrolled in CTE.
- (5) Report data that can be used by policymakers, LEAs, community college districts, and their regional partners to support and evaluate the program, including, to the extent possible, demographic data used to evaluate progress in closing equity gaps in program access and completion, and earnings of underserved demographic groups.

Note: Per Education Code, Section 88830, the Chancellor's Office will verify that required course data files to Cal-PASS Plus have been submitted. Additionally, K12 SWP awardees who did not submit required course data files may be ineligible to apply.

c) Adult Education Programs

- ❖ An Adult Education Program may be included under a district LEA Lead or K–12 Partner Agency application **ONLY** if the program serves students under the age of 18, as approved by the local board. If this is the case, the application should specify the percentage of students served that are under the age of 18.
- ❖ Adult Education Programs may be included in the application as a Collaborative Partner, working with K–12 LEAs, community colleges, and other stakeholders to support pathways to higher education and employment for all students.

E. POSITIVE CONSIDERATIONS

Per Education Code, Section 88830, when determining grant recipients, the K12 Selection Committee shall consider past performance of grantees before awarding additional funds to those reapplying for grants. The K12 Selection Committee shall also give positive consideration to each of the below characteristics in an application:



California Community Colleges

- ❖ Aligned programs serving “unduplicated pupils” defined as a pupil enrolled in a school district or a charter school who is either classified as an English learner, eligible for a free or reduced-price meal, or is a foster youth (Education Code, Section 42238.02).
- ❖ Programs serving pupil subgroups that have higher than average dropout rates as identified by the Superintendent of Public Instruction. (The annual adjusted statewide grades 9–12 dropout rate is 9.0 percent, CDE 2018-19.)
- ❖ Programs located in an area of the state with a high unemployment rate. (Lead LEAs and/or K–12 Partner Agencies to be located in an Area of Substantial Unemployment defined as at or above 6.451%)⁴.
- ❖ Programs that operate within rural school districts.
- ❖ Programs that create new pathways.
- ❖ First-time K12 SWP applicants who have never received K12 SWP funds as a Lead or K–12 Partner Agency.

The K12 Selection Committee, in consultation with the Regional Consortium, has the discretion to give positive consideration to programs to the extent they demonstrate any of the following:

- ❖ Most effectively meet the needs of the local and regional economies.
- ❖ Successfully leverage one or both of the following to support and sustain programs:
 - Existing structures, requirements, and resources of the federal Carl D. Perkins Career and Technical Education Improvement Act of 2006 (20 U.S.C. Sec. 2301 et seq.), or its successor, the partnership academies program pursuant to Article 5 (commencing with Section 54690) of Chapter 9 of Part 29 of Division 4 of Title 2, or the agricultural career technical education incentive program pursuant to Article 7.5 (commencing with Section 52460) of Chapter 9 of Part 28 of Division 4 of Title 2.
 - Contributions from industry, labor, and philanthropic sources.
 - Make significant investments in career technical education infrastructure, equipment, and facilities.

F. PARTNERSHIPS

The K12 SWP encourages and supports intersegmental collaboration—or partnerships between LEAs, postsecondary institutions, workforce agencies, and industry—in developing K–14 CTE courses, programs, and pathways aligned with the Regional Plan. At a minimal requirement, applicants must demonstrate a partnership between the

⁴ Source: California Workforce Innovation and Opportunity Act 2019-20.



California Community Colleges

applying LEAs and at least one California community college or community college district.

Following is a description of the required partners and the recommended partners in K12 SWP partnerships.

a) Higher Education Partners

LEA applicants are required to identify a purposeful partnership with at least one partnering community college or community college district with the intent of developing clearly defined K–14 career pathways for students. LEAs are encouraged to partner with multiple community colleges for developing or supporting multiple K–14 CTE course sequences, programs, or pathways aligned with regional workforce needs.

The LEA–community college collaboration is a mutually beneficial partnership. The LEA can leverage the SWP efforts and resources of the partnering community college, while the community college can anticipate prepared, incoming students for their pathways and better predict student enrollment levels. Moreover, students and employers benefit when students are able to more fully develop knowledge, skills, and abilities through participation in high-skill, high-wage career technical education programs.

In addition to the required partnership with at least one community college or community college district, an LEA may have an additional partnership with four-year colleges, including California State Universities, Universities of California, and private colleges.

b) K–12 Partner Agencies

Collaboration between LEAs is encouraged, though not required. **All other LEAs that are not the Lead Agency on the application, but will receive K12 SWP funds from this strand of work are K–12 Partner Agencies and must be included as such in the application submission under “K–12 Partner Agencies.”** For example, when a county office of education is the Lead Agency, school districts engaged in the K12 SWP work are K–12 Partner Agencies. If the ADA for a K–12 Partner Agency are included on the application as the student population served, then that LEA must also receive K12 SWP funds and is also responsible for submitting all required reports. **If a K–12 Partner Agency will only receive services but not awarded funds, the ADA for that LEA cannot be included as the population served.**

c) Collaborative Partners

LEAs seeking K12 SWP funds are encouraged, though not required, to identify partnerships with Collaborative Partners, which agree to support and inform LEAs as they create, implement, or expand K–14 CTE programs and pathways.

Collaborative Partners include businesses and industry organizations, workforce development agencies, government offices, and philanthropies, among others. Adult



California Community Colleges

Education Programs that serve students over the age of 18 may be included as Collaborative Partners. Collaborative Partners may provide, for example, industry expertise, staff, access to equipment, and/or work-based learning opportunities.

G. MATCH REQUIREMENTS

a) Proportional Dollar Match

Match funds are required and intended to incentivize K–12 institutions and community colleges to invest from their base budgets in the development, support, and expansion of K–14 CTE programs aligned with the workforce needs of California’s regional economies. K12 SWP funds are intended to supplement, not supplant base budgets.

Per Education Code, Sections 88828, (c)(1)(A)(B), any K12 SWP funds awarded, the grantee is required to provide a proportional dollar match as follows:

- For ROCPs operated either by a joint powers authority or by a county office of education, one dollar (\$1) for every one dollar (\$1) awarded. The ROCP needs to be the Lead Agency on the application.
- For all other LEAs, two dollars (\$2) for every one dollar (\$1) awarded.

b) Acceptable and Unacceptable Financial Match Sources

Financial match must directly support and benefit the projects proposed in the grant. Table 4 identifies some acceptable and unacceptable financial match from various sources.

Note: The U.S. Department of the Treasury has issued federal guidance on the permissible use of funding provided through the CARES Act. LEAs should review the federal guidance in order to ensure that they are using their allocation in a manner that is fully compliant with federal law. Visit the [U.S. Department of the Treasury](#) for more federal guidance.



California Community Colleges

Table 4. Acceptable and Unacceptable Financial Match Sources

Acceptable	Unacceptable
School district or charter school Local Control Funding Formula (LCFF) apportionments pursuant to EC Section 42238.02	California Career Technical Education Incentive Grant Program (CTEIG)
Strengthening Career and Technical Education for the 21st Century Act (Perkins V)	Career Technical Education Facilities Program Grant pursuant to EC Section 17078.72
Partnership Academies Program	Public School Facilities Bond (Proposition 51)
Agricultural Career Technical Education Incentive Grant	Past K12 SWP award amounts
California Adult Education Programs (CAEP), as approved by the local board	The same local match that is being used for a California Career Technical Education Incentive Grant
Community College Strong Workforce Program (SWP) that directly serves K– 12 pupils (i.e., dual enrollment, early college credit)	The same local match that is being used for another concurrent K12 SWP grant/application.
Business, industry, philanthropic sources that will directly support the program	In-Kind Match of any kind
Any other source, except those described as “Unacceptable”	

H. APPLICATION DETAILS

a) Application Due Date

The K12 SWP application, the required forms, and all supporting documents must be submitted and certified via the NOVA reporting system on or before **Friday, October 15, 2021, by 5:00pm**, at which time the application system will close. **Printed or faxed copies of the application will not be accepted. Only applications submitted via the NOVA reporting system will be accepted.**

b) Application Review

Each application will be read and scored by a minimum of three trained reviewers from the regional K12 Selection Committee formed by the Regional Consortium in the region in which the applicant is applying. **Application reviews will occur from October 18, 2021, through November 19, 2021.**

The K12 Selection Committee can take a variety of factors into consideration in making their funding decisions and are not required to fund the highest scoring applications that are determined not to align with the regional plans and/or do not meet regional economic needs (Education Code, Sections 88821 and 88830).



California Community Colleges

The K12 Selection Committee reserves the right to adjust the funding amount to align with the proposed scope of work in the application. The K12 Selection Committee may, at its discretion, award less than the amounts requested, based on review of the application and the committee's responsibility to ensure a portfolio of awards that best meets the needs of the region's economy and the intention of the legislation. When determining grant recipients under the K-12 component of the Strong Workforce Program, the K12 Selection Committee shall consider past performance of grantees before awarding additional funds to those reapplying for grants (Education Code, Section 88830(a)).

For information on scoring, application format, and instructions, please see "Section II: Instructions for Preparing and Submitting the K12 SWP Application."

c) Allowable and Non-Allowable Activities and Costs

Budgets for the use of grant funds will be reviewed and scored as part of the application process. Budgets without descriptions and/or that include items deemed non-allowable, excessive, or inappropriate will receive a lower score. Program funds are for direct services to the project only and are intended to supplement, not supplant, existing investments. Applicants should refer to the Strong Workforce Program (Education Code, Sections 88820-88833) and "Appendix C: Guidelines, Definitions, and Allowable Expenditures" to determine specific allowable and non-allowable activities and costs.

d) Administrative Indirect Cost Rate

An LEA may take a maximum of 4% administrative indirect costs for the term of the grant. This is the approved rate set by the Chancellor's Office. Visit the [California Department of Education](#) website for guidelines regarding direct and indirect costs.

e) Incomplete and Late Applications

Incomplete or late applications will not be considered. The Chancellor's Office and K12 Selection Committees reserve the right to reject any and all applications received prior to scoring should the following occur:

- ❖ The application is not received and certified via submission through the NOVA reporting system by **5:00pm on Friday, October 15, 2021**. NOVA will not accept applications after the deadline.
- ❖ The budget exceeds the maximum amount allowed as specified in the Request for Application instructions.
- ❖ The application does not meet the match requirement funding levels and/or indicates that the match comes from non-allowable sources.
- ❖ The application is incomplete and/or missing any required documents.



California Community Colleges

f) Performance Period

Successfully awarded project applications will be funded from January 2022 to June 2024. There will be no extensions to the performance period.

I. CALENDAR OF KEY DATES FOR K12 SWP GRANT CYCLE

Table 5. Calendar of Key Dates for K12 SWP Grant Cycle

Date	Event
August 16, 2021	K12 SWP Application Released/NOVA platform opens
August 24, 2021	Bidders' Conference Webinar
September 1, 2021	NOVA platform training posted to Chancellor's Office website
September 17, 2021	Questions Submission deadline to K12SWP@cccco.edu
October 1, 2021	Regional Engagement Information Sessions conclude
October 15, 2021	K12 SWP Applications due in NOVA system
November 19, 2021	K12 Selection Committees review period concludes
November 23, 2021	K12 SWP preliminary awards announced
December 10, 2021	Appeals due to SWP Regional Consortium
December 24, 2021	SWP Regional Consortia communicate intent to award funds to LEAs and initiate subcontract process
January 2022	K12 SWP project term begins
June 2024	K12 SWP project term ends

J. TECHNICAL ASSISTANCE

Bidders' Conference Webinar. The Chancellor's Office staff will host an informational Bidders' Conference Webinar to provide an overview of the project submission process and offer potential applicants an opportunity to ask additional clarifying questions. Failure to attend the webinar will not preclude the submission of an application. The webinar will be recorded for posting on the [K12 Strong Workforce Program](#) webpage.

Date and Time: Tuesday, August 24, 2021, 1:00pm – 2:30pm PT.

[Register for the K12 SWP Bidder's Conference Webinar.](#)



California Community Colleges

K12 Pathway Coordinators (K12 PCs) are available for each Community College District and their contact information can be found on the [K12 Strong Workforce Program](#) webpage. In addition, K14 Technical Assistance Providers (K14 TAPs) are available for each region (please see table below).

Table 6. K14 Technical Assistance Providers

Region	K14 TAPs	Email Address
Bay Area	Sharon Turner Don Harjo Daves-Rougeaux	turnersharon@fhda.edu don@baccc.net
Central/Mother Lode	Diane Baeza	Diane.Baeza@tcoe.org
Inland Empire/Desert	Stephanie Murillo	Stephanie.Murillo@rccd.edu
Los Angeles	Linda Bermudez	Bermudez_Linda@rscdd.edu
North/Far North	Tanya Meyer	tmeyer@frc.edu
Orange County	Michael Sacoto	Sacoto_Michael@rscdd.edu
San Diego/Imperial	Leslie Wisdom	Leslie.Wisdom@gcccd.edu
South Central Coast	Dr. Giselle Bice	giselle.bice@canyons.edu

K. RFA CLARIFICATION

If any ambiguity, conflict, discrepancy, omission, or other error in this RFA is discovered, immediately notify the Chancellor’s Office of the error and request a written modification or clarification of the document. A clarifying addendum will be given to all parties who have obtained the RFA, without divulging the source of the request. Insofar as practical, the Chancellor’s Office will give such notice to other interested parties, but the Chancellor’s Office shall not be responsible for failure to do so.

Written questions concerning the specifications and instructions in this Request for Applications must be submitted by email to K12SWP@cccco.edu **no later than Friday, September 17, 2021, at 5:00pm**. Questions submitted prior to **Tuesday, August 24, 2021**, will be addressed at the Bidders’ Conference Webinar. Questions received after that date will be addressed in a subsequent Frequently Asked Questions (FAQs) document posted on the Frequently Asked Questions section of the [K12 Strong Workforce Program](#) webpage.

Following the question deadline of **Friday, September 17, 2021**, only technical questions (e.g., questions about accessing the NOVA system, logistical challenges using NOVA or the K12 SWP online application, etc.) will be answered. No response will be provided to content questions submitted to K12SWP@cccco.edu after that date.



California Community Colleges

L. APPEALS PROCESS

Applicants who wish to appeal a grant award decision must submit a letter of appeal to the Regional Consortium for the region in which the application was submitted. **The Regional Consortium must receive the letter of appeal, with a signature by the authorized person, no later than 5:00pm on Friday, December 10, 2021.** Only e-mailed letters will be accepted. The final decision will be provided in writing within two weeks from the date that appeals are due or by **December 24, 2021.** The Regional Consortium’s decision shall be the final administrative action afforded the appeal.

Appeals shall be limited to the grounds that the K12 Selection Committee failed to correctly follow the specified processes for reviewing the application. The appellant must file a full and complete written appeal, including the issue(s) in dispute, the legal authority or other basis for the appeal position, and the remedy sought. Incomplete or late appeals will not be considered. The appellant may not supply any new information that was not contained in the original application.

Appeals should be submitted to the Regional Consortium at the following email addresses:

Table 7. Contact Information for Regional Chairs

Region	Regional Chair	Email Address
Bay Area	Rock Pfothenauer	rock@bacc.net
Central/Mother Lode	Janice Offenbach	janice.offenbach@reedleycollege.edu
Inland Empire/Desert	Julie Pehkonen	julie.pehkonen@rcc.edu
Los Angeles	Dr. Adriene “Alex” Davis (Interim)	Davis_Adriene@rscdd.edu
North/Far North	Blaine Smith	smithbl@butte.edu
Orange County	Jesse Crete (Interim)	crete_jesse@rscdd.edu
San Diego/Imperial	Danene Brown	danene.brown@gcccd.edu
South Central Coast	Luann Swanberg	lrswanberg@pipeline.sbccc.edu



California Community Colleges

SECTION II: INSTRUCTIONS FOR PREPARING AND SUBMITTING THE K12 SWP APPLICATION

A. CREATING A NOVA ACCOUNT/ACCESSING YOUR NOVA ACCOUNT

The K12 SWP Application is housed in the Chancellor's Office NOVA system. NOVA allows users to plan, invest, and track their investments across different programs.

If you are a new user, visit the [Request Access to NOVA](#) webpage to create an account or if you are a returning user, you can access your existing [NOVA Account](#) here.

B. NOVA TECHNICAL ASSISTANCE

NOVA Platform Applicant Training Webinar. The Chancellor's Office staff will provide a training video on using the NOVA online application platform. The training video will be pre-recorded and posted on the [K12 SWP website](#). For questions related to the NOVA system that are not addressed in the webinar, please contact K12SWP@cccco.edu.

Training Video Posting Date: Wednesday, September 1, 2021

C. SUBMITTING THE K12 SWP APPLICATION

Once you create a NOVA account, you can submit an application. In NOVA, go to the sidebar menu; click "Programs" then "K12 SWP" and "Applications." Click "Create New Application" button to begin.

D. APPLICATION FORMAT AND INSTRUCTIONS

The following instructions describe the content and format of the application. Only applications submitted via the NOVA system will be accepted. In order to receive the highest possible score and to prevent disqualification, the application instructions in NOVA must be followed, all questions must be answered, and all requested information must be supplied.

Applicants may be required to make adjustments in the budget, work plan, or other aspects of the application prior to distribution of funds.

Note: Grant applications are scored based on a 100-point scale as indicated in the list provided below. New K12 SWP applicants and applications proposing new CTE programs and/or pathways are eligible to receive up to 10



California Community Colleges

additional points (5 points for new CTE programs and/or pathways and 5 points for new K12 SWP applicants). Please note that these 10 points are in addition to the 100 points. A minimum average score of 75 must be obtained during the review process, which includes multiple readers and scoring rubrics, to be considered for funding.

Table 8. Application Sections

Application Section	Maximum Points
1. Pathway Identification	Not Scored/Required
2. Lead Local Education Agency (LEA)	Not Scored/Required
3. K-12 Partner Agencies (LEA)	Not Scored/Optional
4. Higher Education Partners	Not Scored/Required
5. Collaborative Partners	Not Scored/Optional
6. Problem Statement and Project Objectives	40 Points
7. Positive Considerations	20 Points
8. Industry Sectors and Pathways	Not Scored/Required
9. CTE Pathway/Program Work Plan	35 Points
10. Budget	15 Points
11. Assurances	Not Scored/Required
12. Supporting Documentation	Not Scored/Required

(1) Pathway Identification (Maximum Points: Not Scored/Required)

- (a) Pathway/Project Title.
- (b) Project Start and End Dates for proposed work.
- (c) Prior K12 SWP Awards: If applicable, please indicate for which round your organization, as a Lead or a K-12 Partner Agency, was awarded K12 SWP funds:
 - Round 1: 2018-19
 - Round 2: 2019-20
 - Round 3: 2020-21
- (d) CTEIG Award: If applicable, please indicate whether your organization was awarded funds in 2020-21 and whether your organization has applied for 2021-22 CTEIG funds.

Note: If available, K12 SWP applicants who were awarded funds as a Lead or K-12 Partner Agency may be requested to include information on prior awards



California Community Colleges

including a brief description of efforts K12 SWP awarded funds have supported to date.

(2) Lead Local Education Agency (LEA) (Maximum Points: Not Scored/ Required)

- (a) **Lead LEA Type:** Select the Agency Type from the drop-down list. The Lead Agency/fiscal agent on the application must be one of the following eligible LEAs: school district, county office of education, direct-funded charter school, or ROC/P operated by a joint powers authority or county office of education. If applying as an ROC/P based at a county office of education, be sure to select the appropriate ROC/P option.
- (b) **Lead LEA:** Select the LEA that will serve as the Lead Agency for this CTE Pathway/Program Plan. If the agency cannot be found or if the information is inaccurate, please contact the K12 SWP help desk by clicking the link in the instructions. (Address and ADA for Lead LEA are auto-populated by NOVA.)
- (c) **Lead LEA Primary Contact:** Please identify the individual who will serve as Primary Contact for this Pathway/Program Plan. Include name, phone, and email. If applicable, include Lead LEA Reporting Designee.

Note: Awarded K12 SWP LEA Leads must:

- **Agree to the Statements of Assurance (in NOVA),**
- **Ensure the Lead LEA and all K–12 Partner Agencies have an MOU with Cal-PASS Plus,**
- **Ensure all required Progress and Fiscal and Cal-PASS Plus reports are submitted on behalf of all K–12 Partner Agencies,**
- **Have an invoice process for all K–12 Partner Agencies (sub-grantees), and**
- **Share K12 SWP-relevant communications and information with all partners.**

Any K12 SWP LEA not in compliance may be ineligible for future K12 SWP funding.

- (d) **Participating Schools:** Enter each of the lead LEA's school(s) that is participating in the Pathway/Program Plan.
- (e) **Pathway/Program Region:** Select the region in which you are applying. The LEA shall be located in and offer instruction within the geographical boundaries of the region from which it is applying for funds. LEAs that offer site-based instruction in multiple regions should apply within the region where the participating site is located. LEAs that offer primarily online/virtual instruction may apply only in the region within which its chartering district is located.



California Community Colleges

(3) K–12 Partner Agencies (Local Education Agency: LEA) (Maximum Points: Not Scored/Optional)

For each K–12 Partner Agency provide:

- (a) K–12 Partner Agency Type from the drop-down list.
- (b) K–12 Partner Agency: Select the K–12 Partner Agency for this CTE Pathway/Program Plan. (Address and ADA for K–12 Partner Agency are auto-populated by NOVA.)

Note: If the ADA for a K–12 Partner Agency is included in the application, that K–12 Partner Agency must:

- Receive K12 SWP awarded funds and
- Submit all required K12 SWP Progress, Fiscal, and Cal-PASS Plus reports.

Any K12 SWP LEA not in compliance may be ineligible for future K12 SWP funding.

- (c) K–12 Partner Agency Primary Contact: Please identify the individual who will serve as Primary Contact. Include name, phone, and email. (Contact information must be provided for each K–12 Partner Agency.)
- (d) K–12 Participating Schools: Enter each of the partner LEA's K–12 schools that are participating in the CTE Pathway/Program.

(4) Higher Education Partner(s) (Maximum Points: Not Scored/Required)

For each Higher Education Partner provide:

- (a) CCC Partner: Select the CCC/CCD Partner for this CTE Pathway/Program Plan.
- (b) Please note that the K12 SWP requires an intersegmental partnership between the K–12 system and at least one California community college (CCC) or California community college district (CCD). (Address for CCC Partner(s) is auto-populated by NOVA.)
- (c) CCC Primary Contact: Please identify the individual who will serve as Primary Contact for this college's participation in the CTE Pathway/Program Plan. Include name, phone, and email. (Contact information must be provided for each Partner.)
- (d) (OPTIONAL) Additional Higher Education Partner(s): If applicable, select any additional higher education partners participating in the Pathway/Program Plan. Please note that additional higher education partners may include four-year colleges, including California State Universities, Universities of California, and private colleges.



California Community Colleges

(5) Collaborative Partners (Maximum Points: Not Scored/Optional)

For each Collaborative Partner provide:

- (a) Collaborative Partner: List the Collaborative Partner name and identify partner type and their proposed role for this CTE Pathway/Program Plan. Include name, phone, and email. (Contact information must be provided for each Partner.)

Collaborative Partner(s) Types include: Businesses, community organizations, industry organizations, philanthropic organizations, workforce development agencies, and government agencies, among others.

Collaborative Partner Roles include: Fiscal/financial contribution, partnership and subject-matter expertise, curriculum development/alignment, work-based learning experiences for students, and externship experience for educators and administrators, among others.

Note: The K12 SWP Lead LEA must identify and include contact information within NOVA for the following parties:

- **Project Lead:** Please designate one individual to be the first point of contact for the entire project. The Project Lead is the accountable party for the project.
 - Permissions include:
 - submitting and editing the application
 - editing project plan budgets and contacts
 - submitting and editing progress and expenditure reports
- **Project Lead Alternate(s):** Multiple individuals can be assigned to this role. The Alternate(s) will not be the first point of contact but will have the same permissions as the Project Lead. Communication through the NOVA system will only be received by the Project Lead.
 - Permissions include:
 - submitting and editing the application
 - editing project plan budgets and contacts
 - submitting and editing progress and expenditure reports
- **Project Contributor & Reporter:** Multiple individuals can be assigned to this role. The Project Contributor & Reporter can contribute to the application but cannot submit. This is the role that should be provided to anybody that is not a lead but is a delegate of the lead.
 - Permissions are limited to:
 - submitting and editing expenditure reports
 - editing project plans
- **Project Viewer:** Multiple individuals can be assigned to this role. The role of Project Viewer is for information purposes only. Permissions are limited to view only.



California Community Colleges

(6) Problem Statement and Project Objectives (Maximum Points: 40)

(a) Problem Statement (Maximum Points: 20 points)

Provide a brief Problem Statement that is concise, clear, and evidence-based, supporting the problem or need that your K12 SWP efforts will address (2,500 characters maximum).

Problem Statements should:

1. Be informed by the region's Strong Workforce Program (SWP) Regional Plan and/or region's Labor Market Information.
2. Identify the sector/industry challenge(s) or need(s) the proposed K12 SWP plan(s) will address.
3. Include sector/industry data that supports the identified challenges or need(s).
4. Use data to identify equity gaps of how student subgroups (e.g., race, gender, socioeconomics) access, experience opportunities, and complete high school course work that are aligned to STEM and high-potential CTE programs at disproportionate rates. Specifically, include evidence from demographic, enrollment, and completion data to substantiate the targeted student population to be served.

(b) Project Objectives (Maximum Points: 20 points)

Provide clear, concrete Project Objectives which this project aims to achieve, to address the issues in the Problem Statement. Include how the LEA(s) is using the K12 SWP funds to help meet those objectives. Avoid statements of lofty goals (2,500 characters maximum).

Project Objectives should:

1. Align to the Problem Statement
2. Be informed by region's Strong Workforce Program Plan and/or region's Labor Market Information
3. Identify efforts to align career pathway(s) and/or program(s) to postsecondary pathways.
4. Describe efforts to close equity gaps by improving access to and completion of high-skill/high-wage CTE opportunities for disproportionately impacted students. Include activities that are designed to intentionally improve outreach and increase targeted academic supports, such as tutoring, mentoring by professionals, and work-based learning.

(7) Positive Considerations (Maximum points: 20)

1. Area of Substantial Unemployment: System will display if the Lead LEA and/or Partner LEAs are located in a county considered an Area of



California Community Colleges

Substantial Unemployment defined as at or above 6.451%. (Source: California Workforce Innovation and Opportunity Act 2019–20.)

2. **Rural School Districts:** System will display if the Lead LEA and/or Partner LEAs operate within rural school districts.
3. **Dropout Rate:** Indicate whether the proposed CTE program(s) serves student subgroups that have a dropout rate higher than the state dropout rate.
4. **Unduplicated Pupils:** Indicate whether the proposed CTE program(s) serves the following unduplicated pupils: English learners, students who qualify for free or reduced-price meals, or students who are designated foster youth (EducationCode, Section 42238.02).
5. **Special Populations:** Indicate whether the proposed CTE program(s) serves K–12 students that are defined as special populations per Perkins V.
6. **New CTE Programs/Pathways:** Indicate whether one or more new CTE programs/pathways are proposed.
7. **New K12 SWP Applicant:** Indicate whether the Lead and/or K–12 Partner Agency has **never** been awarded K12 SWP awards as a Lead or K–12 Partner Agency on any prior round of funding.

(8) Industry Sectors and Pathways (Maximum Points: Not Scored/Required)

- (a) Please select the appropriate Industry Sectors you plan to target. The California Department of Education Industry Sectors are cross-walked with the California Community Colleges. When you select the appropriate CDE sector(s), the associated sector(s) will automatically populate.
- (b) Proposed CTE Pathway/Program Work. Select the pathway(s) to be included in the Pathway/Program Plan. At least one pathway must be selected.
- (c) Identify the design purpose of the proposed K12 SWP work and for each, list the number of Pathways/Programs involved.
 - Create a new pathway(s)
 - Scale an existing pathway(s)

It is acceptable for a project's scope of work to focus on only one design purpose.

(9) CTE Pathway/Program Work Plan (Maximum Points: 35)

- (a) High-Quality CTE Program Evaluation (Upload Program Evaluation from your 2021-22 CTEIG Application in the "Supporting Documents" section). A



California Community Colleges

- D. Identify number of students and/or teachers to be served and the way in which they will be served and Justification for requested funds and plans for sustaining the effort (Return on Investment)
- E. Describe activities designed to improve access to and completion of high-skill/high-wage CTE opportunities for disproportionately impacted students. Include activities that are designed to intentionally improve outreach and increase targeted academic supports, such as tutoring, mentoring by professionals, and work-based learning.

Complete only the forms that reflect the Strategy in which K12 SWP funds will support.

Note: For the K12 SWP Round 4 application, work plan details will be entered directly into the NOVA platform. A work plan practice template, scoring rubrics, and additional resources can be downloaded from the [K12 Strong Workforce Program website](#).

Review the K12 SWP Scoring Rubrics to ensure that your work plan addresses each criterion that will contribute to the overall work plan score. For example, when providing “Description of work funded by K12 SWP,” address the issues in the Problem Statement, how proposed activities will improve CTE programs or pathways, how access and engagement for underserved students will change, and any intermediary steps planned.

(d) Leveraging other CTE Funds to Support this Work

Identify the additional funding sources that will support this work. Check all that apply.

- LCFF (general funds)
- Perkins V (Strengthening Career and Technical Education for the 21st Century Act)
- CTEIG (California Technical Education Incentive Grant)
- Agricultural Career Technical Education Incentive Grant
- CTEFP (Career Technical Education Facilities Program/Prop 51)
- CPA (California Partnership Academies grants)
- SSP (Specialized Secondary Programs grant)
- SWP (Strong Workforce Program)
- Other: _____

(10) Budget (Maximum Points: 15)

Budget: Each Lead LEA and K–12 Partner Agency (if applicable) must prepare a budget by object code, provide descriptions, and identify match funds. The budget plan should demonstrate measurable and actionable outcomes.



California Community Colleges

- (a) Use the Budget and Match template as a planning tool from which information can be copied and entered into NOVA.

A budget template, budget example, and additional resources can be downloaded from the [K12 Strong Workforce Program](#) website.

- (b) Include how the grant funds will be distributed to each Lead Agency and K–12 Partner Agency for each fiscal year the proposed work will span. The template allows for expenditure object code 1000–7000.

1000 – Certificated Salaries: Certificated CTE teacher salaries

2000 – Classified Salaries: Classified salaries associated with CTE programs only

3000 – Employee Benefits: Only those benefits associated with CTE teacher salaries

4000 – Books and Supplies: Only those expenses related to CTE courses

5000 – Services and Other Operating Expenditures: Only those charges related to CTE teachers and CTE programs

6000 – Capital Outlay: Only those expenses related to CTE courses

7000 – Indirect Costs

The total budget will populate based on the amounts entered. This is not a guarantee of being funded the grant award amount that corresponds to the proposed match.

Please see “Section I: General Information” as well as “Appendix C: Guidelines, Definitions, and Allowable Expenditures” for information about allowable costs and administrative indirect cost rates.

(11) Assurances

A duly authorized representative for the Lead LEA should review all assurances, certifications, and terms and conditions to be familiar with the grant expectations. Please upload the Assurance Agreement form into NOVA attesting that this Pathway/Program is:

- In compliance with K12 SWP legislation (Education Code, Section 88827-88828(c)(8)(C)):
 - All partners will report outcomes and financials in the NOVA and Cal-PASS Plus systems.
- Aligned with your district(s)/partner district(s) 2021–22 LCP.
- Informed by, aligned with, and expands upon your region’s Regional Plan and planning efforts occurring through the Strong Workforce Program.
- Informed by Labor Market Information and regional priorities.



California Community Colleges

- Staffed by skilled teachers or faculty and provides professional development opportunities for those teachers or faculty members.

Please attest to the assurances that the Lead LEA and Partners will:

- Report data that can be used by policymakers, LEAs, community college districts, and their regional partners to support and evaluate the program, including, to the extent possible, demographic data used to evaluate progress in closing equity gaps in program access and completion, and earnings of underserved demographic groups.

(12) Supporting Documentation

Applicants **must** upload the following documents:

- Completed 2021–22 High-Quality CTE Program Evaluation for each applicable LEA participating in this work,
- A signed agreement (Statement of Assurance) with each K–12 Partner Agency whose ADA is included on the application as the students served, and
- MOUs with Cal-PASS Plus for the K12 SWP Lead LEA (if applicable) and all K–12 Partner Agencies or an action plan with expected timeline for securing MOUs.

Do not upload any other types of documents, as they will not be reviewed or factored in the scoring process.

E. DOWNLOADABLE APPLICATION TOOLS

For your convenience, the required application materials, scoring rubrics, and practice templates are available and downloadable. The below referenced application tools and resources can be downloaded from the [K12 Strong Workforce Program](#) website.

- a. CTE Pathway/Program Work Plan practice template
- b. CTE Pathway/Program Problem Statement and Project Objectives EXAMPLE
- c. CTE Pathway/Program Budget and Match template
- d. CTE Pathway/Program Budget and Match EXAMPLE
- e. CTE Pathway/Program Scoring Rubrics
- f. Statement of Assurance
- g. High-Quality CTE Program Evaluation (*required*) can be downloaded from the [California Department of Education](#) website.



California Community Colleges

APPENDIX A: GRANTEE REQUIREMENTS AND GUIDELINES

A. ALIGNMENT WITH GUIDING POLICY PRINCIPLES TO SUPPORT K–14+ PATHWAYS

The California Workforce Pathways Joint Advisory Committee (CWPJAC) developed the Guiding Policy Principles to Support K–14+ Pathways to help prioritize a policy pivot towards purposeful integration of the student experience across systems and into college and career, while addressing industry workforce needs. The CWPJAC recommends incorporating the following Guiding Policy Principles in K12 SWP implementation:

- ❖ **Focus on a Student-Centered Delivery of Services** for all K–14+ college and career pathways, which accommodates multiple entry points to facilitate students' needs to build their skills as they progress along a continuum of education and training or advance in a sector-specific occupation or industry.
- ❖ **Promote Equity and Access** by eliminating institutional barriers and achievement gaps for all students to realize their educational and career aspirations.
- ❖ **Achieve System Alignment** in the economic regions of the state in order to create a comprehensive and well-defined system of articulation of high-quality K–14+ pathway courses (i.e., both in-person and online) and work-based learning opportunities with a specific emphasis on career technical education. Bring greater coherence to programming, common use of terminology, appropriate data collection and sharing, and attainment of student outcomes in a timely way that lead to upward mobility in California's industry sectors.
- ❖ **Support the Continuous Improvement and Capacity Building** at all levels and components to ensure smooth transitions in the system and focus efforts on implementation of state standards, attainment of student outcomes, and a strengthening of California's regional economies.

B. LEVERAGING PARTNERSHIPS AND CTE FUNDING SOURCES

(a) Examples of Leveraging SWP at Partnering Community Colleges

Following are a few examples of how LEAs can leverage a partnering community college's existing SWP efforts.

- ❖ The partnering community college offers dual enrollment and articulated courses as part of K–14 CTE pathways so that high school students can earn early college credit and enter college CTE programs with advanced standing.



California Community Colleges

- ❖ The partnering community college can share course syllabi and collaborate with K–12 to create vertical alignment in CTE pathways.
- ❖ The partnering community college counselors and the K–12 counselors collaborate so that students stay on their chosen pathway as they transition from secondary to postsecondary education.
- ❖ The partnering community college has an SWP-funded CTE coordinator, who is responsible for outreach and marketing of CTE programs, including promoting the K–14 pathways at secondary schools and ROCPS. The CTE coordinator can host open houses, provide college tours, speak to high school students and their parents, and share marketing collateral with the high school community.
- ❖ The partnering community college offers its college students apprenticeships and work-based learning opportunities through its relationships with industry. Additional work-based learning opportunities for high school CTE pathways can be established with the same industry organizations.

(b) Working Norms for Intersegmental Partnerships

Providing students with a seamless CTE pathway from K–12 through postsecondary education is a central component of the K12 SWP objectives. To support intersegmental partnerships between K–12 LEAs, institutions of higher education, and Collaborative Partners, the CWPJAC recommends these working norms in building student-centered, high-quality, K–14 college and career pathways:

1. Frequent, open, and intentional communication between educational agencies, workforce agencies, and employers.
2. A mindset shift from insular to coordination of planning and from independent to interdependent implementation of systems to make better use of and maximize scarce public funds.
3. A continual scan for opportunities to leverage, build upon, and/or replicate effective models and practices in order to benefit from the scale of the state.
4. An understanding of the existing eco-system as a basis to build a new culture for our institutions and incentivize behaviors and relationships.
5. Ongoing alliances through sustained funding and mutual agreements in order to “stay the course” despite governance changes.
6. A commitment to the work to create stability and sustainability of the K–14+ college and career pathway system.



California Community Colleges

C. LEVERAGING MULTIPLE CTE FUNDING SOURCES

LEAs are expected to support their CTE programs and pathways primarily through funds from the Local Control Funding Formula (LCFF), ensuring that the programs and pathways are integral to the LEAs' programs of study. K12 SWP is intended to assist LEAs in building their capacity to leverage funds from their LCFF and other possible Federal and State CTE funding sources—such as Perkins V and CTEIG—to build strong pathway programs. In doing so, LEAs are demonstrating a commitment to improve CTE opportunities for students through high-quality programs and pathways.

Following is an example of how LEAs can leverage funding sources.

A high school plans to expand its CTE program, and it strategically leverages its different funding sources: Funds from LCFF are budgeted for the hiring of a new CTE teacher; CTEIG funds support professional development and the purchase of new equipment; Perkins V funds support student services for special populations and increased recruitment of such students; while K12 SWP funds support modifying the “a-g” curriculum with an industry focus on career pathways and skills, building connections with its local community college to provide dual enrollment courses, and establishing work-based learning opportunities with local businesses.

D. PROGRAM OUTCOME MEASURES

The long-term measures of success for the K12 SWP are the students completing high school, transitioning successfully into an aligned postsecondary program, graduating with a degree or credential in a high-demand field, and securing employment successfully. The K12 SWP Metrics are designed to measure student-level outcomes from K–12 to postsecondary education and employment. Only four metrics measure K–12 student-level outcomes, while the remaining metrics apply to postsecondary student-level outcomes and employment outcomes.

The K12 SWP Metrics that measure **K–12 student-level outcomes**:

- Completed 2+ CTE courses in high school in the same program of study.
- Completed 2+ CTE courses in high school in the same program of study that include early college credit, work-based learning, or third-party certification.
- Graduated high school.
- Enrolled in a CA Community College within one year of leaving secondary school.

The K12 SWP Metrics that measure **postsecondary student-level outcomes**:

- Entered registered apprenticeship after participation in high school pre-apprenticeship program.
- Enrolled in another form of job training (other than CA Community College).
- Completed 9+ CTE units in first year of CA Community College.
- Attained a CA Community College certificate/degree or journey-level status.



California Community Colleges

- Transferred to a four-year institution after exiting CA Community College.

The K12 SWP Metrics that measure **employment student-level outcomes**:

- Employed in a job closely related to field of study after exiting CA Community College.
- Median annual earnings of students after exiting CA Community College.

E. REPORTING REQUIREMENTS

a) Program Outcome Measures Reporting

As a K12 SWP grant recipient, LEAs must collect extra data elements in addition to those required by CDE. The K12 SWP grant recipients (both Lead and K–12 Partner Agencies) must submit the required end-of-the-year files to CDE by November 1, immediately following the fiscal year for which data are being reported.

Grant recipients must also notify their region's K–14 Technical Assistance Provider that data has been reported by the due date. The Regional Consortium may end contracts and grants from grantees that do not provide the required outcomes-based data.

In addition, to ensure that the K12 SWP legislative reporting requirements are met, all grant recipients, both lead and partnering LEAs, are required to upload end-of-year data files, as applicable and required by K12 SWP.

In addition, to ensure that the K12 SWP legislative reporting requirements are met, all grant recipients, both Lead LEA and K–12 Partner Agencies, are **required** to do the following:

1. Ensure an active MOU is on file with Cal-PASS Plus throughout the life of the awarded grant and
2. Submit and/or ensure all required Progress and Fiscal and Cal-PASS Plus reports are submitted on behalf of all K–12 Partner Agencies (see Table 9 for details).

b) Progress and Fiscal Reporting (see Table 9 for details)

To ensure the successful implementation of the K12 SWP, grant recipients are required to submit:

- five (5) Progress and Expenditure Reports via the NOVA Reporting System,
- three (3) Annual Course Data Reports via Cal-PASS Plus, and
- one (1) Final Report K12 Expenditure Report and Outcomes via the NOVA Reporting System.

The required reports demonstrate that grant recipients have met the dollar-for-dollar match requirement (specified in Education Code, Section 88828) and are providing program deliverables using the K12 SWP funds pursuant to Education Code, Section



California Community Colleges

88827. It is the responsibility of the lead LEA to ensure that all K–12 Partner Agencies on the project submit mid-year progress and expenditure reports either on their own or to the lead LEA to submit on their behalf. Failure to submit required reports or evidence that deliverables have been met could result in the loss and/or remittance of all awarded funds.

The following reports are to be submitted by the due dates indicated. Extensions of reporting deadlines may be made with the approval of the Regional Consortium.

Table 9. K12 SWP Progress and Expenditure Report Due Dates

Date	Reports Due	Reporting System	Time Period
July 29, 2022	First Progress and Expenditure Report	NOVA	January 2022 through June 2022
	Annual Course Data Report	Cal-PASS Plus	January 2022 through June 2022
January 27, 2023	Second Progress and Expenditure Report	NOVA	July 2022 through December 2022
July 28, 2023	Third Progress and Expenditure Report	NOVA	January 2023 through June 2023
	Annual Course Data Report	Cal-PASS Plus	July 2022 through June 2023
January 26, 2024	Fourth Progress and Expenditure Report	NOVA	July 2023 through December 2023
July 26, 2024	Fifth Progress and Expenditure Report	NOVA	January 2024 through June 2024
	Annual Course Data Report	Cal-PASS Plus	July 2023 through June 2024
October 31, 2024	Final K12 SWP Expenditure Report and Outcomes	NOVA	January 2022 through June 2024



California Community Colleges

APPENDIX B: Appendix Program-Specific Legal Terms, and Conditions

A. COST AND PAYMENTS

In consideration of satisfactory performance of the services described in the Grantee's application, the applicable Strong Workforce Program Career Technical Education Regional Consortium (hereinafter Regional Consortium) agrees to pay the Grantee a total amount not to exceed the "Grant Funds" amount stated on the fully executed Grant Agreement. Payment should be made as follows:

Beginning in 2021, an advance payment of 70% of the total amount of this Grant Agreement will be paid, upon receipt of an invoice, after the Grant Agreement is fully executed.

Grantee may request progress payment(s) up to 20% of the total amount of this Grant Agreement upon submission of an invoice and accompanying documentation as required by the Regional Consortium and completion of all reports due at the time the invoice is submitted. Payment of the final 10% will be made upon receipt of an invoice and accompanying documentation as required by the Regional Consortium, and review and approval by the Regional Consortium of expenditure/progress reports and the final report.

B. WORK TO BE PERFORMED

The Grantee shall complete the tasks described in the Grantee's application and funds shall be expended in compliance with the requirements for the funding source and Grant Agreement with the Regional Consortium.

C. MODIFICATION/BUDGET CHANGES

Grantee may request modifications to the work to be performed. All such requests must be submitted in writing to the Regional Consortium prior to the modification being made. The Regional Consortium may require that a Grant Amendment be processed if the Regional Consortium determines that the change would materially affect the project outcomes or the term of this Grant Agreement.

Grantee may make changes to any budget category amounts up to 10% of the total award amount per line item without the approval of the Regional Consortia so long as budget categories are not added or deleted, the total dollar amount of the Grant Agreement is not affected, and the outcomes of the Grant Agreement will not be materially affected. Grantee may add or delete budget categories subject to the prior approval of the Regional Consortium.



California Community Colleges

Grant amendments are required for budget changes when there are changes in the total dollar amount of the Grant Agreement and/or the outcome of the Grant Agreement is materially affected. The process for requesting and approving grant amendments are determined by the Regional Consortium. Budget changes or amendments are subject to applicable program limitations and require approval of the Regional Consortium. No extensions to the performance period will be granted.

Grantees are required to fully expend their grants by the end of the expenditure period. If a grantee projects that they will be unable to do so, they should contact the Regional Consortium and arrange to have their grant reduced to a level which the grantee is confident can be fully spent within the expenditure period. If a Regional Consortium has reason to question whether a grantee can fully expend their grant within the expenditure period, it may request that the grantee provide evidence that it will be able to do so.

When grant funds are unexpended, the unspent funds will go to the next round of K12 SWP funding for the region in which it was awarded.

D. ASSURANCES, CERTIFICATES, TERMS, AND CONDITIONS

Assurances, certifications, terms, and conditions are requirements of applicants and grantees as a condition of receiving funds. The certified K12 SWP application is a commitment to comply with the assurances, certifications, and terms and conditions associated with the grant as described in the K12 SWP Request for Applications and K12 SWP legislation (Education Code, Sections 88820-88833).

As a condition of receiving funds, funded applicants shall do the following:

- Enter into a grant agreement with the applicable Strong Workforce Program Regional Consortium that may include terms and conditions provided by the Chancellor's Office and the applicable Regional Consortium.
- Certify that all identified partners are aware of this grant application and agree to its submission.
- Be responsible for the performance of any services provided through funds awarded under this grant by partners, consultants, or other organizations.
- Certify to the K12 Selection Committee that grant funds received and the matching funds contributed by each local educational agency shall be used solely for the purpose of supporting the program or programs for which the grant is awarded.
- Make expenditure data on career technical education programs available for purposes of determining if the grant recipients have met the matching funds requirements specified in subdivision (c) of Section 88828, and for monitoring the use of funds provided pursuant to Section 88827.
- Every year, the awarded grantees (Lead LEAs and K-14 Partners) must provide student-level data necessary to evaluate K12 SWP as required by Legislation and submit required end-of-year data files.



California Community Colleges

APPENDIX C: GUIDELINES, DEFINITIONS, AND ALLOWABLE EXPENDITURES

A. DETERMINING IF A COST IS ALLOWABLE

All allowable costs must meet three primary criteria: (1) Substantiate that the cost was necessary and reasonable for proper and effective administration of the allocations; (2) The cost must be allocable to the funding source activities; and (3) The cost must not be a general expense required to carry out the grantee overall responsibilities (not supplanting). However, even if the costs meet the prior three criteria, the costs must be approved within the statement of work/budget of the individual fiscal agent; otherwise, they are not allowable within that year without changes to the statement of work/budget. In addition, the Regional Consortium has the discretion to impose special conditions beyond the funding source that would also determine allowability of cost.

While the proposed cost is allowable under the funding source, is it also reasonable?

A cost is reasonable if, in its nature and amount, it does not exceed that which would be incurred by a prudent person under the circumstances prevailing at the time the decision was made to incur the cost.

Systems that can guide this definition are necessary for the performance of the grant; following sound business practices (procurement processes, follow state and local laws, follow the terms of the grant); use of fair market prices; acting with prudence under the circumstances; and having no significant deviation from established prices.

What are the guidelines of allocable?

Allocable is defined by the dictionary as capable of being allocated or assigned. A cost is considered allocable to a particular funding source/program to the extent it actually benefits the objectives of that program. You can only charge in proportion to the value received by the funding source/program. An example would be that a Project Director works 80% on the funded program (only 80% of the salary and benefits can be charged in the grant application). Beyond this definition, allocable also means that the cost must be related to the statement of work/budget that have been approved by the Consortium.

What is supplanting?

Strong Workforce K12 funds must supplement and not supplant state or local funds. Funding may not result in a decrease in state or local funding that would have been available to conduct the activity had these funds not been received. Strong Workforce K12 funds may not free up state or local dollars for other purposes but should create or augment programs to an extent not possible without Strong Workforce K12 dollars. You must be able to



California Community Colleges

demonstrate that Strong Workforce K12 funds are added to the amount of state and local funds that would, in absence of Strong Workforce K12 funds, be made available for uses specified in your plan. Allocation recipients and sub-recipients must use grant funds to provide extra goods, services, materials, staff coordination positions, etc. that would not otherwise be purchased with state, local, or other non-Strong Workforce K12 funds.

Allowable and Non-Allowable Activities and Costs

Budgets for the use of grant funds will be reviewed and scored as part of the application process. Items deemed non-allowable, excessive, or inappropriate will be eliminated and the budget adjusted accordingly. Budgets that include non-allowable, excessive, or inappropriate items will receive a lower score. Generally, all expenditures must contribute to student success in the career pathways program.

Table 10. Allowable and Non-Allowable Activities and Costs

Allowable Activities & Costs	Non-Allowable Activities & Costs
Service contracts between members of the consortium or external service providers and technical assistants.	Supplanting existing funding or efforts, including costs otherwise necessary to operate a school or program without this grant.
Costs to extend or create a new non-profit intermediary organization to link employers and educational institutions with a primary purpose of aggregating and making available work opportunities for students. Such an entity could convene and lead stakeholders, research labor market needs and align supply and demand for work-based learning and communicate the purpose and goal of the career pathways initiative within the region.	Providing sub-grants to members of the partnership or other agencies. This includes mini grants, which are different than purchase service contracts.
Fund career specialists to convene, connect, measure, or broker efforts to establish or enhance locally defined career pathways programs, and to support the provision of workplace learning opportunities for all participating students.	Expenditures for CTE courses prior to the 7th grade.
Indirect or Administrative Expenditures (Rate approved by the Chancellor's Office is 4%).	Acquiring equipment for administrative or personal use.
Meetings and Conferences – in which the primary purpose is the dissemination of technical information (meals, transportation, rental of facilities, and other items incidental to such meetings or conferences. Please be aware not to cross over into entertainment	Purchasing furniture (e.g., bookcases, chairs, desks, file cabinets, tables) unless it is an integral part of an equipment workstation or to provide reasonable accommodations to students with disabilities.



California Community Colleges

Allowable Activities & Costs	Non-Allowable Activities & Costs
<p>costs. Must obtain prior approval from the Regional Consortium.</p> <ul style="list-style-type: none"> Note: Food is only allowed at meetings that require a working breakfast, lunch or dinner and disseminate technical information to participate. The meeting must have an agenda that shows a working meal, must have a sign-in sheet for participants and cannot go over the fiscal agent's per diem guidelines for food purchases. 	
<p>Purchase evidence-based and/or standards-based curriculum or instructional materials that focus on a career pathway.</p>	<p>Purchase food services, refreshments, banquets, and/or meals not for working meetings.</p>
<p>Development of curriculum or instructional materials that emphasizes rigorous content within a career pathway.</p>	<p>Purchasing facilities; Remodeling facilities not directly related to accessibility to career pathways instruction or services.</p>
<p>Professional development to enhance teaching and learning, including collaborative secondary and postsecondary development of aligned curriculum and instruction.</p>	<p>Purchasing promotional favors, such as bumper stickers, pencils, pens, or T-shirts.</p>
<p>Purchase of equipment needed to upgrade existing programs or new equipment to start a career pathway program.</p>	<p>Purchasing subscriptions to journals or magazines.</p>
<p>Technical skills assessment (industry recognized certification exams/assessments). The industry certification must be part of a course, certificate, or program of the capstone activity.</p>	<p>Traveling outside of the United States.</p>
<p>Training and planning meetings between consortium personnel, including counselors, parents, college faculty, and business leaders, to support program sustainability and build awareness in the regions on the benefits for having such programs.</p>	<p>Providing activities or services for students not enrolled in a career pathways program.</p>
<p>Travel - Only travel necessary for the project is allowed. Travel costs are the expenses for transportation, lodging, subsistence, and related items incurred by employees who are in travel status on official business for the grant. Such costs will be based on the fiscal agent's per diem rates. These costs shall be considered reasonable and allowable only to</p>	



California Community Colleges

Allowable Activities & Costs	Non-Allowable Activities & Costs
<p>the extent such costs do not exceed charges normally allowed by the institution in its regular operations as the result of the institution's written travel policy.</p> <p>OUT-OF-STATE TRAVEL: Out-of-state travel will be closely scrutinized and must be disclosed in the Budget summary. After the application is fully executed, any further out-of-state travel requires prior approval of the Regional Consortia by submitting the necessary (as determined by the Regional Consortia) documentation for approval. The Regional Consortium reserve the right to limit out-of-state travel.</p>	
<p>Postsecondary curriculum development that facilitates alignment and articulation with secondary programs leading to college degrees and/or other industry- recognized credentials that meet the needs of employers.</p>	

9.16

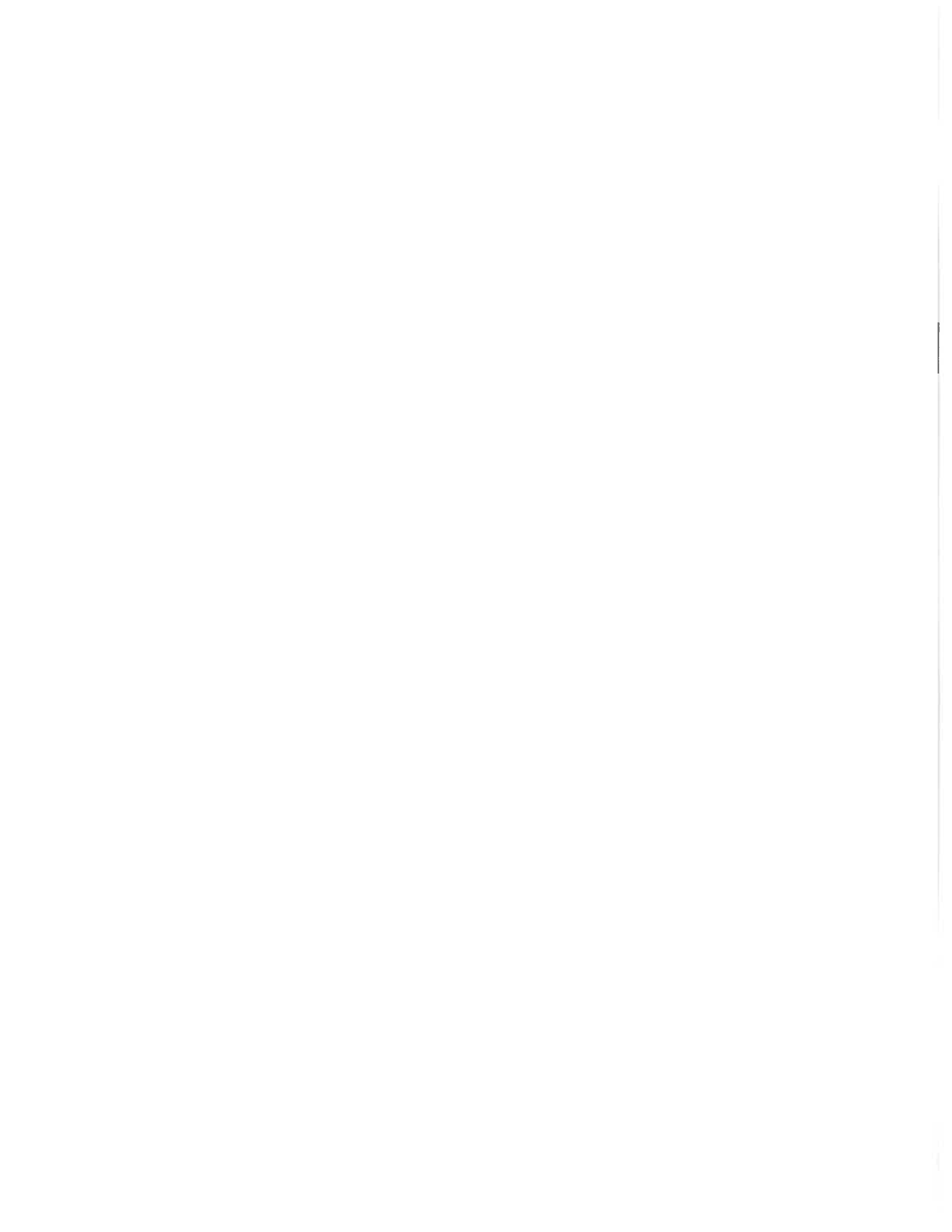



Agenda Item Details

Meeting	Jun 29, 2022 - RSD Regular Board Meeting
Category	9. Consent
Subject	9.16 Contract with Boys and Girls Club of Greater Oxnard and Port Hueneme to provide summer staffing and programs for 2022
Access	Public
Type	Action (Consent)
Fiscal Impact	Yes
Dollar Amount	270,213.00
Budgeted	Yes
Budget Source	After School Education and Safety (ASES) and Expanded Learning Opportunities
Recommended Action	Staff recommends board approval of Boys and Girls Club Contract.

Public Content

Speaker: Oscar Hernandez, Assistant Superintendent Educational Services

Rationale:

Boys and Girls Club of Greater Oxnard and Port Hueneme (BGCOP) has historically supported the EXPLORE Program by providing staffing. The EXPLORE Program provides expanded learning opportunities targeting students who are eligible for free or reduced priced meals, English learners, experiencing homelessness, and/or are foster youth. In collaboration with BGCOP, the EXPLORE program will offer programs equalling a nine-hour day for from July 6, 2022-August 5, 2022. Programs will include sports, outdoor education, writing, and more.

RSD BGCOP Summer 2022 MOU EA-signed (1).pdf (1,130 KB)

Administrative Content

Executive Content

Our adopted rules of Parliamentary Procedure, Robert's Rules, provide for a consent agenda listing several items for approval of the Board by a single motion. Most of the items listed under the consent agenda have gone through Board

subcommittee review and recommendation. Documentation concerning these items has been provided to all Board members and the public in advance to assure an extensive and thorough review. Items may be removed from the consent agenda at the request of any board member.

RIO SERVICES AGREEMENT

Requisition Number

Purchase Order Number

Contract Number

This Services Agreement (the "Agreement") is made and entered into this 1st day of July 2022 to June 30, 2022. By Rio School District (hereinafter referred to as "District") and Boys & Girls Clubs of Greater Oxnard and Port Hueneme (BGCOP), (hereinafter referred to as "Provider.")

PROVIDER.

Boys & Girls Clubs of Greater Oxnard

And Port Hueneme (BGCOP)

Provider

(805) 815-4959

Telephone Number

1900 West Fifth Street

Street Address

(805) 815-4709

Fax Number

Oxnard, CA 93030

City, State, Zip code

eantrim@bgcop.org

E-mail Address

95-1785162

Tax Identification or Social Security Number

License Number (if applicable)

Type of Business

Individual

Sole Proprietorship

Partnership

Corporation

Other-501c3 Non-Profit _____

- A. District desires to engage Provider services as more particularly described on "Statement of Work" which is attached hereto and incorporated herein by this reference ("Services").
- B. Provider has the necessary qualifications by reason of training, experience, preparation and organization, and is agreeable to performing and providing such Services, upon and subject to the terms and conditions as set forth below in this Agreement.

NOW THEREFORE, for valuable consideration, the receipt and sufficiency of which are hereby acknowledged, the parties hereto hereby agree as follows:

1. **CONDITIONS.** Provider will have no obligation to provide services until District returns a signed copy of this Agreement.
2. **NATURE OF RELATIONSHIP.** The parties agree the relationship created by this Agreement is that of independent contractor. In performing all of the Services, Provider shall be, and at all times is, acting and performing as an independent contractor with District, and not as a partner, coventurer, agent, or employee of District, and nothing contained herein shall be construed to be inconsistent with this relationship or status. and is not granted any right or authority to assume or to create any obligation or responsibility, express or implied, on behalf of or in the name of District or to bind the District in any manner. Except for any materials, procedures, or subject matter agreed upon between Provider and District, Provider shall have complete control over the manner and method of performing the Services.

Provider understands and agrees to independent contractor status. Provider understands and agrees that the filing and acceptance of this Agreement creates a rebuttable presumption and that the Provider, officers, agents, employees, or subcontractors of Provider are not entitled to coverage under the California Workers' Compensation Insurance laws, Unemployment Insurance, Health Insurance, Pension Plans, or any other benefits normally offered or conveyed to District employees. Provider will be responsible for payment of all Provider employee wages, payroll taxes, employee benefits, and any amounts due for federal and state income taxes and Social Security taxes. These taxes will not be withheld from payments under this agreement.

3. **NON-EXCLUSIVITY.**
 - a. During the term of this agreement Provider may, independent of Provider's relationship with the District, without breaching this Agreement or any duty owed to the District, act in any capacity, and may render services for any other entity.
 - b. During the term of this Agreement the District may, independent of its relationship with the Provider, without breaching this Agreement or any duty owed to the Provider contract with other individuals and entities to render the same or similar services to the District.
4. **SERVICES.** Provider shall provide District with the services, which are described on the "Statement of Work" (the "Work" or "Service") attached hereto and incorporated herein by this reference. The Statement of Work shall contain a timetable for completion of the Work or if the Work is an ongoing service, the Statement of Work shall set forth the mutually agreed schedule for providing such services. Provider shall use its best efforts to complete all phases of the Work according to such timetable. In the event that there is any delay in completion of the Work arising as a result of a problem within the control of

District, Provider and District shall cooperate with each other to work around such delay. However, District shall not be responsible for any additional cost or expense to Provider as a result of such delay unless specifically agreed to in writing by the District. In addition to the specifications and/or requirements contained in the Statement of Work and any warranty given by Provider hereunder, the Statement of Work may set forth those performance criteria agreed between District and Provider whereby the District can evaluate whether Provider has satisfactorily completed the Work ("Performance Criteria").

Provider, at Provider's sole cost and expense, shall furnish all tools, equipment, apparatus, facilities, transportation, labor, and material necessary to meet its obligations under this Agreement. No substitutions of materials or service from those specified in this section shall be made without the prior written consent of the District.

5. **TIME OF PERFORMANCE.** The term of this Agreement shall commence on July 1, _____, 2022, and terminate on June 30, _____, 2023. All work and services contracted for under the terms of this Agreement shall be undertaken and completed in such sequence as to assure their full completion in accordance with the terms and conditions set forth in this Agreement.

6. **PAYMENT AND EXPENSES.** All payments due to Provider are set forth in the "Schedule of Fees" attached hereto and incorporated herein by this reference.

Provider shall send District periodic statements indicating Provider's fees and costs incurred and their basis and any current balance owed. If no Provider's fees or costs are incurred for a particular time period, or if they are minimal, the statement may be held by the Provider and combined with that for the following time period unless a statement is requested by the District.

All payments due Provider are set forth in "Schedule of Fees" and shall be paid by the District within 30 days of receipt of a proper invoice from Provider, which invoice shall set forth in reasonable detail the services performed. The District reserves the right, in its sole and absolute discretion, to reject any invoice that is not submitted in compliance with the District's standards and procedures. In the event that any portion of an invoice submitted by a Provider to the District is disputed, the District shall only be required to pay the undisputed portion of such invoice at that time, and the parties shall meet to try to resolve any disputed portion of any invoice.

The rates set forth in "Schedule of Fees" are not set by law, but are negotiable between Provider and District.

7. **ASSIGNMENT AND SUBCONTRACTORS.** Provider shall not assign, sublet, or transfer this Agreement or any rights under or interest in this Agreement without the prior written consent of the District, which may be withheld by the District in its sole and absolute discretion for any reason. Nothing contained herein shall prevent Provider from employing independent associates, subcontractors, and subconsultants as Provider may deem appropriate to assist in the performance of services herein, subject to the prior written

approval of the District. Any attempted assignment, sublease, or transfer in violation of this Agreement shall be null and void, and of no force and affect. Any attempted assignment, sublet, or transfer in violation of this Agreement shall be grounds for the District, in its sole discretion, to terminate the Agreement

8. **TERMINATION OR AMENDMENT.** This Agreement may be terminated or amended in writing at any time by mutual written consent of all of the parties to this Agreement, and may be terminated by either party for any reason by giving the other party 60 days advance written notice. In the event of cancellation prior to completion of the specified services, all finished or unfinished projects, documents, data, studies, and reports prepared by the Provider under this agreement shall, at the option of the District, become District property. The Provider shall be entitled to receive just and equitable compensation for any satisfactory work completed on such items prior to termination of the Agreement.

The parties to this Agreement shall be excused from performance thereunder during the time and to the extent they are prevented from obtaining, delivering, or performing due to act(s) of God. Satisfactory evidence thereof to the other party is required, provided that it is satisfactorily established that the non-performance is not due to the fault or neglect of the party not performing.

9. **NOTICE.** Any notices required or permitted to be given under this Agreement shall be deemed fulfilled by written notice, demand or request personally served on (with proof of service endorsed thereon, or mailed to, or hereinafter provided) the party entitled thereto or on its successors and assigns. If mailed, such notice, demand, or request shall be mailed certified or registered mail, return receipt requested, and deposited in the United States mail addressed to such party at its address set forth below or to such address as either party hereto shall direct by like written notice and shall be deemed to have been made on the third (3rd) day following posting; or if sent by a nationally recognized overnight express carrier, prepaid, such notice shall be deemed to have been made on the next business day following deposit with such carrier. For the purposes herein, notices shall be sent to the District and the Provider as follows:

Rio School District
District

BGCOP
Provider

Attn: Sonya Lopez Mercado, Ed.D.

Attn: Erin Antrim

1800 Solar Dr. 3rd Floor
Street

1900 West Fifth Street
Street

Oxnard, CA 93030
City, State, Zip Code

Oxnard, CA 93030
City, State, Zip Code

10. **WARRANTY.** Provider hereby warrants to District that the Work shall be performed in a professional and workmanlike manner consistent with the highest industry standards. For a period of one (1) year following completion of the Work, Provider shall correct or make

arrangements to correct any breach of the warranty for the Work within ten (10) business days of notice from District of same.

11. **ADDITIONAL WORK.** If changes in the work seem merited by the Provider or the District, and informal consultations with the other party indicate that a change is warranted, it shall be processed by the District in the following manner:
- a. A letter outlining the changes shall be forwarded to the District by the Provider with a statement of estimated changes in fee and/or time schedule.
 - b. A written amendment to this Agreement shall be prepared by the District and executed by all of the parties before any performance of such services or the District shall not be required to pay for the increased cost incurred for the changes in the scope of work.

Any such amendment to the Agreement shall not render ineffective or invalidate unaffected portions of this Agreement.

12. **COMPLIANCE WITH LAWS.** Provider hereby agrees that Provider, officers, agents, employees, and subcontractors of Provider shall obey all local, state, and federal laws and regulations in the performance of this Agreement, including, but not limited to minimum wages laws and/or prohibitions against discrimination.

Provider, officers, agents, employees and/or subcontractors of Provider shall secure and maintain in force for the full term of this Agreement, at Provider's sole cost and expense, such licenses and permits as are required by law, in connection with the furnishing of all the Services, materials, or supplies necessary for completion of the Services described.

Provider shall be responsible for all costs of clean up and/or removal of spilled regulated substances as a result of Provider's services or operations performed under this Agreement, including, but not limited to:

- Hazardous and toxic substances,
- Hazardous waste,
- Universal waste,
- Medical waste,
- Biological waste,
- Sharps waste.

13. **PREVAILING WAGE.** Provider shall comply with the California Labor Code regarding the payment of the general prevailing per diem wage rates for public work (construction) projects of more than one thousand dollars (\$1,000).

14. **NON-DISCRIMINATION AND EQUAL EMPLOYMENT OPPORTUNITY**

Provider represents and agrees that it does not and shall not discriminate against any employee or applicant for employment because of race, religion, color, sex, or national origin.

15. **INDEMNIFICATION.** Provider agrees to defend, indemnify, and hold harmless District, its officers, agents, employees, and/or volunteers from any and all claims, demands, losses, damages and expenses, including legal fees and costs, or other obligations or claims arising out of any liability or damage to person or property, or any other loss, sustained or claimed to have been sustained arising out of activities of the Provider or those of any of its officers, agents, employees, or subcontractors of Provider, whether such act or omission is authorized by this Agreement or not. Provider shall also pay for any and all damage to the Real and Personal Property of the District, or loss or theft of such Property, done or caused by such persons. District assumes no responsibility whatsoever for any property placed on District premises by Provider, Provider's agents, employees or subcontractors. Provider further hereby waives any and all rights of subrogation that it may have against the District. The provisions of this Indemnification do not apply to any damage or losses caused solely by the negligence of the District or any of its officers, agents, employees, and/or volunteers.

16. **INSURANCE.** Provider, at its own cost and expense, shall procure and maintain during the term of this Agreement, policies of insurance for the following types of coverage:

Workers' Compensation Insurance. Provider shall procure and maintain, during the term of this Agreement, Workers' Compensation Insurance, as required by California law, on all of its employees engaged in work related to the performance of this Agreement. In the case of any such work which is subcontracted, Provider shall require all subcontractors to provide Workers' Compensation Insurance for all of the subcontractor's employees to be engaged in such work unless such employees are covered by the protection afforded by the Provider's Workers' Compensation Insurance.

Commercial General Liability Insurance. Provider shall procure and maintain, during the term of this Agreement, not less than the following General Liability Insurance coverage:

	Each Occurrence	Aggregate
Individual, Sole Proprietorship, Partnership, Corporation, or Other	\$ 1,000,000.00	\$ 2,000,000.00
High risk events or activities	\$ 2,000,000.00	\$ 4,000,000.00
Severe risk events or activities	\$ 5,000,000.00	\$ 10,000,000.00

Commercial General Liability insurance shall include products/completed operations, broad form property damage, and personal and advertising injury coverage.

Provider's and any and all Provider subcontractor's Commercial General Liability insurance and Abuse and Molestation coverage shall name the District, its employees, and school board members as additional insureds.

Insurance written on a "claims made" basis is to be renewed by the Provider and all Provider subcontractors for a period of five (5) years following termination of this Agreement. Such insurance must have the same coverage and limits as the policy that was in effect during the term of this agreement, and will cover the provider for all claims made.

Failure to Procure Insurance. Failure on the part of Provider, or any of its subcontractors, to procure or maintain required insurance shall constitute a material breach of contract under which the District may immediately terminate this Agreement.

17. **SAFETY AND SECURITY.** Provider shall be responsible for ascertaining from the District all of the rules and regulations pertaining to safety, security, and driving on school grounds, particularly when children are present.

Certain entities that contract with a school district are required to comply with Education Code section 45125.1 regarding fingerprinting requirements unless the district determines that the Provider will have limited contact with students.

- Provider and any and all subcontractors are required to comply with Education Code section 45125.1, Fingerprint certification requirements. Provider must provide proof that fingerprint certification requirements have been fulfilled prior to commencing any services for the District under this Agreement.
- Provider and its subcontractors are not required to comply with Education Code section 45125.1, Fingerprint certification requirements.
- Transportation Providers are required to comply with Education Code section 49406, Examination for Tuberculosis requirements. Provider must cause to be on file with the District a certificate from the examining physician showing the Provider, employees and/or subproviders of Provider have been examined and found free from active tuberculosis.

18. **PROTECTION OF WORK AND PROPERTY.** Provider and all of its subcontractors shall maintain at all times, as required by conditions and progress of work, all necessary safeguards for the protection of employees and the public. In an emergency affecting life and safety of life or work or of adjoining property, Provider is permitted, without special instruction or authorization from the District, to act at its discretion to prevent such threatened loss or injury.

19. **GOVERNING LAW AND VENUES.** Provider hereby acknowledges and agrees that District is a public entity, which is subject to certain requirements and limitations. This Agreement and the obligations of District hereunder are subject to all applicable federal,

state and local laws, rules, and regulations, as currently written or as they may be amended from time to time.

This Agreement shall be interpreted in accordance with the laws of the State of California. If any action is brought to interpret or enforce any term of this Agreement, the action shall be brought in state or federal court situated in the County of Ventura, State of California. Provider hereby waives and expressly agrees not to assert, in any way, any claim or allegation that it is not personally subject to the jurisdiction of the courts named above. Provider further agree to waive any claim or allegation that the suit, action, or proceeding is either brought in an inconvenient forum or that the related venue is improper.”

20. **ARBITRATION.** Any dispute arising under this Agreement, including, without limitation, all disputes relating in any manner to the performance or enforcement of this Agreement shall be resolved by binding arbitration in Ventura County pursuant to the rules of the American Arbitration Association (AAA), as amended or as augmented in this Agreement (the “Rules”). The parties acknowledge that one of the purposes of utilizing arbitration is to avoid lengthy and expensive discovery and allow for prompt resolution of the dispute.

Arbitration shall be initiated as provided by the Rules, although the written notice to the other party initiating arbitration shall also include a description of the claim(s) asserted and the facts upon which the claim(s) are based. Arbitration shall be final and binding upon the parties and shall be the exclusive remedy for all claims subject hereto, including any award of attorneys’ fees and costs. Either party may bring an action in court to compel arbitration under this Agreement and to enforce an arbitration award.

All disputes shall be decided by a single arbitrator. The arbitrator shall be selected by mutual agreement of the parties within 30 days of the effective date of the notice initiating the arbitration. If the parties cannot agree on an arbitrator, then the complaining party shall notify the AAA and request selection of an arbitrator in accordance with the Rules. The arbitrator shall have only such authority to award equitable relief, damages, costs, and fees as a court would have for the particular claim(s) asserted. In no event shall the arbitrator award punitive damages of any kind.

The arbitrator shall have the power to limit or deny a request for documents or a deposition if the arbitrator determines that the request exceeds those matters, which are directly relevant to the claims in controversy. The document demand and response shall conform to Code of Civil Procedure section 2031. The deposition notice shall conform to Code of Civil Procedure section 2025. The parties may make a motion for protective order or motion to compel before the arbitrator with regard to the discovery, as provided in Code of Civil Procedure sections 2025 and 2031.

21. **ATTORNEYS FEES.** In the event of any action or proceeding to interpret or enforce the terms of this Agreement, the prevailing party, as determined by the court or arbitrator, shall

be entitled to recover its reasonable attorneys fees and costs incurred in connection with such actions or proceeding

22. **DOCUMENT RETENTION.** After Provider's services to District conclude, Provider shall, upon the District's request, deliver all documents for all matter in which Provider has provided services to the District, along with any property of the District in Provider's possession and/or control. If the District does not request District's document(s) for a particular service, Provider will retain document(s) for a period of two (2) years after the service has ended. If District does not request delivery of the document(s) for the service before the end of the two (2) year period, Provider will have no further obligation to retain the document(s) and may, at Provider's discretion, destroy it without further notice to the District. At any point during the two (2) year period, District may request delivery of the document(s).

Exceptions: Attorney work-product and medical records shall not be destroyed by provider without the prior written consent of the District.

23. **NATURE OF AGREEMENT.** This Agreement constitutes a binding expression of the understanding of the parties with respect to the services to be provided hereunder and is the sole contract between the parties with respect to the subject matter thereof. There are no collateral understandings or representations or agreements other than those contained herein. This Agreement represents the entire agreement between the parties hereto with respect to the subject matter hereof and supersedes any and all other agreements and communications however characterized, written or oral, between or on behalf of the parties hereto with respect to the subject matter hereof. This Agreement may only be modified by a written instrument signed by authorized representatives of each of the parties hereto.
24. **BINDING EFFECT.** This Agreement shall inure to the benefit and shall be binding upon all of the parties to this Agreement, and their respective successors in interest or assigns.
25. **WAIVER.** No claim or right arising out of a breach of this Agreement can be discharged in whole or in part by a waiver or renunciation of the claim or right unless such waiver is in writing.
26. **SEVERABILITY.** It is intended that each paragraph of this Agreement shall be treated as separate and divisible, and in the event that any paragraphs are deemed unenforceable, the remainder shall continue to be in full force and effect so long as the primary purpose of this Agreement is unaffected.
27. **PARAGRAPH HEADINGS.** The headings of paragraphs hereof are inserted only for the purpose of convenient reference. Such headings shall not be deemed to govern, limit, modify or in any other manner affect the scope, meaning or intent of the provisions of this Agreement or any part or portion thereof, nor shall they otherwise be given any legal effect whatsoever.

28. **AUTHORITY.** Provider represents and warrants that Provider has all requisite power and authority to conduct its business and to execute, deliver, and perform this Agreement. Each party warrants that the individuals who have signed this Agreement have the legal power, right, and authority to make this Agreement and to bind each respective party.
29. **COUNTERPART EXECUTION: ELECTRONIC DELIVERY.** This Agreement may be executed in any number of counterparts which, when taken together, shall constitute one and the same instrument. Executed counterparts of this Agreement may be delivered by PDF email or electronic facsimile transmission, and shall have the same legal effect as an "ink-signed" original.

IN WITNESS WHEREOF, the parties have executed this agreement as of the date first written above.

Rio School District

 District

Boys & Girls Clubs of Greater Oxnard

And Port Hueneme (BGCOP)
 Provider

By: _____
 Signature
John Puglisi, Ph.D.
 Name
Superintendent
 Title



 Signature
Erin Antrim
 Name
CEO
 Title

Approved as to form:

 Signature

 Name
 District Counsel

STATEMENT OF WORK

DESCRIPTION OF WORK:

Provider will hire and supervise EXPLORE program staff for the following programs and locations:

2022 Summer Program

Rio del Norte	6 staff x 10 hours
Rio del Valle	6 staff x 10 hours
Rio Lindo	7 staff x 10 hours
Rio Plaza (at Rio del Mar)	7 staff x 10 hours
Rio Real (at Rio Lindo)	8 staff x 10 hours
Rio Rosales	5 staff x 10 hours

Provider and the District shall collaboratively appoint and employ staff members at each Program Location (hereinafter "Professional Staff"). District site coordinators and Provider director will interview and approve all Professional Staff hires. The Program Administrator shall specifically ensure, in part, that all Professional Staff who directly supervise pupils meet the minimum qualifications to serve as an Instructional Aide in the District. The District human resources department will administer the "Instructional Assistant Examination" for the expanded learning program staff hiring pool and will provide verification to Provider for their hiring process.

BGCOP shall serve as the sole employer of all Provider employees required to staff the Program, and shall exercise authority to supervise and evaluate its employees, except as expressly provided herein.

Professional staff for each Program Location shall provide the following direct EXPLORE Program services:

- Develop daily lesson plans and weekly schedules for program
- Lead classes of no more than 20 students
- Supervise students
- Record daily attendance
- Attend all District-provided professional development opportunities

WORK SCHEDULE:

2022 Summer Program

After School Program Director (ASPD): 1 x \$22 per hour x 10 hours per day x 23 days = \$5,060
for Summer break 7/6/22-8/5/22

After School Program Leads (ASPL): 9 x \$21 per hour x 10 hours per day x 23 days = \$39,330 for
Summer break 7/6/22-8/5/22

Youth Development Specialists (YDS):

Professional Development 15 hours of training for 39 staff dates and times TBD

Rio School District Expanded Learning Summer Budget 9 Sites 2022-2023 7/6/22-8/5/22 Boys and Girls Clubs of Greater Oxnard and Port Hueneme		
	Budget Line Items	Amount Budgeted
Series 1000		\$0
CERTIFICATED PERSONNEL SALARIES TOTAL		\$0
	<u>After School Program Director (ASPD):</u> 1 x \$22 per hour x 10 hours per day x 23 days = \$5,060 for Summer break 7/6/22-8/5/22	\$5,060
Series 2000	<u>After School Program Leads (ASPL):</u> 9 x \$21 per hour x 10 hours per day x 23 days = \$39,330 for Summer break 7/6/22-8/5/22	\$43,470
	<u>Youth Development Specialists (YDS):</u> 30 x \$18 per hour x 10 hours per day x 23 days = \$124,200 for Summer break 7/6/22-8/5/22	\$124,200
CLASSIFIED PERSONNEL SALARIES TOTAL		\$172,730
SERIES 3000	<u>After School Program Director (ASPD):</u> 20% x \$5060 for employer paid costs (work's comp, taxes, medical, unemployment)	\$1,012
	<u>After School Program Leads (ASPLs):</u> 20% x \$43,470 for employer paid costs (work's comp, taxes, medical, unemployment)	\$8,694
	<u>Youth Development Specialists:</u> 20% x \$124,200 for employer paid costs (worker's comp, taxes, medical, unemployment)	\$24,840
	<u>Line staff sick leave:</u> 24 hours per staff	\$17,496
EMPLOYEE BENEFITS TOTAL		\$52,042

SERIES 4000	Instructional Resources & supplies provided by BGC \$0 per youth for 0 youth = \$0 Cell Phone and Wireless Card	\$0 \$0
BOOKS AND SUPPLIES TOTAL		\$0
SERIES 5000	Transportation for Field Trips Professional Development 15 hours of training for 39 staff BGCOP operating expenses	\$0 \$10,935 \$23,571
SERVICES AND OTHER OPERATING EXPENSES TOTAL		\$34,506
SUBTOTAL FOR SERIES 1000-5999		\$270,213.00
SERIES 6000		\$0
EQUIPMENT AND EQUIPMENT REPLACEMENT TOTAL		\$0
Indirect Costs 7000	Indirect costs may not exceed the grantee's restricted indirect cost rate (ICR), or 5%, whichever is less. Programs may expend up to 15% of annual funding on administrative costs. Total Series 1000-5999 = <u>\$112,500</u> x ICR 5% = \$5,625	\$0
SUBTOTAL SERIES 1000-5999 INCLUDING INDIRECT COSTS		\$270,213.00
GRAND TOTAL		\$270,213.00

SCHEDULE OF FEES

FEES:

Compensation for Services	\$ _____
Actual and Necessary Travel Expenses	\$ _____
Other Expenses	\$ _____
Total Amount not to Exceed	\$ <u>270,213</u>
Deposit	\$ _____
Balance Due after Completion of Services	\$ _____

Proper invoicing is required. Receipts for expenses are required. Canceled checks are not accepted as receipts.

PAYMENT SCHEDULE:

60% at the beginning of summer and 40% at the conclusion of the summer program

ADDITIONAL COSTS OF EXPENSES:

9.17

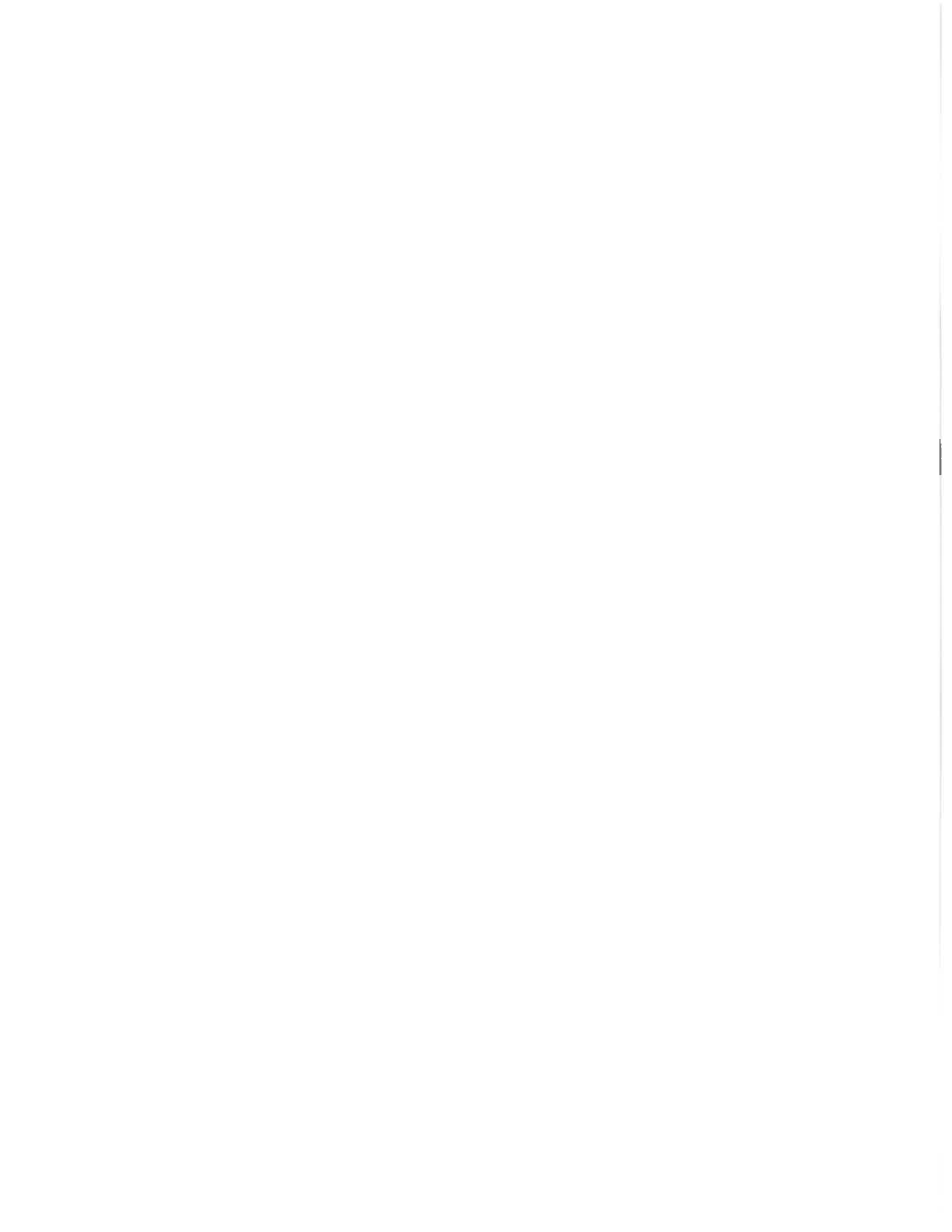



Agenda Item Details

Meeting	Jun 29, 2022 - RSD Regular Board Meeting
Category	9. Consent
Subject	9.17 Contract with Catalyst Kids, Inc. to provide summer PreK STEAM Camp
Access	Public
Type	Action (Consent)
Fiscal Impact	Yes
Dollar Amount	45,400.00
Budgeted	Yes
Budget Source	Expanded Learning Opportunities Program
Recommended Action	Staff recommends board approval of the Catalyst contract.

Public Content

Speaker: Oscar Hernandez, Assistant Superintendent Educational Services

Rationale:

The Rio School District has had a long-standing partnership with Early Childhood Education provider, Catalyst Kids, Inc. (formerly known as CDI). Per the Expanded Learning Opportunities guidelines, districts must make ELOP-funded programs available to transitional kindergarten and kindergarten students and provide nine-hour programs during summer, winter, or spring breaks and/or Saturdays. In conjunction with the three-hour Summer Jump Start Program, the PreK STEAM camp will offer Rio families a nine-hour day option.

Rio-Catalyst Summer STEAM Camp 2022_signed.pdf (301 KB)

Administrative Content

Executive Content

Our adopted rules of Parliamentary Procedure, Robert's Rules, provide for a consent agenda listing several items for approval of the Board by a single motion. Most of the items listed under the consent agenda have gone through Board

subcommittee review and recommendation. Documentation concerning these items has been provided to all Board members and the public in advance to assure an extensive and thorough review. Items may be removed from the consent agenda at the request of any board member.

RIO SERVICES AGREEMENT

Requisition Number _____

Purchase Order Number _____

Contract Number _____

This Services Agreement (the "Agreement") is made and entered into this 31st day of May 2022, by and between Rio School District (hereinafter referred to as "District") and Catalyst Family Inc. dba Catalyst Kids, (hereinafter referred to as "Provider.")

PROVIDER.

Catalyst Family Inc. dba Catalyst Kids
350 Woodview Ave, Suite 100
Morgan Hill 95037
408-556-7300
RCHAMPAGNE@catalystkids.org
EIN 94-2376637

Type of Business

- | | |
|--------------------------------------|---|
| <input type="checkbox"/> Individual | <input type="checkbox"/> Sole Proprietorship |
| <input type="checkbox"/> Partnership | <input checked="" type="checkbox"/> Corporation |
| <input type="checkbox"/> Other _____ | |

- A. District desires to engage Provider services as more particularly described on "Statement of Work" which is attached hereto and incorporated herein by this reference ("Services").
- B. Provider has the necessary qualifications by reason of training, experience, preparation and organization, and is agreeable to performing and providing such Services, upon and subject to the terms and conditions as set forth below in this Agreement.

NOW THEREFORE, for valuable consideration, the receipt and sufficiency of which are hereby acknowledged, the parties hereto hereby agree as follows:

1. **CONDITIONS.** Provider will have no obligation to provide services until District returns a signed copy of this Agreement.

2. **NATURE OF RELATIONSHIP.** The parties agree the relationship created by this Agreement is that of independent contractor. In performing all of the Services, Provider shall be, and at all times is, acting and performing as an independent contractor with District, and not as a partner, coventurer, agent, or employee of District, and nothing contained herein shall be construed to be inconsistent with this relationship or status. and is not granted any right or authority to assume or to create any obligation or responsibility, express or implied, on behalf of or in the name of District or to bind the District in any manner. Except for any materials, procedures, or subject matter agreed upon between Provider and District, Provider shall have complete control over the manner and method of performing the Services.

Provider understands and agrees to independent contractor status. Provider understands and agrees that the filing and acceptance of this Agreement creates a rebuttable presumption and that the Provider, officers, agents, employees, or subcontractors of Provider are not entitled to coverage under the California Workers' Compensation Insurance laws, Unemployment Insurance, Health Insurance, Pension Plans, or any other benefits normally offered or conveyed to District employees. Provider will be responsible for payment of all Provider employee wages, payroll taxes, employee benefits, and any amounts due for federal and state income taxes and Social Security taxes. These taxes will not be withheld from payments under this agreement.

3. **NON-EXCLUSIVITY.**
 - a. During the term of this agreement Provider may, independent of Provider's relationship with the District, without breaching this Agreement or any duty owed to the District, act in any capacity, and may render services for any other entity.
 - b. During the term of this Agreement the District may, independent of its relationship with the Provider, without breaching this Agreement or any duty owed to the Provider contract with other individuals and entities to render the same or similar services to the District.
4. **SERVICES.** Provider shall provide District with the services, which are described on the "Statement of Work" (the "Work" or "Service") attached hereto and incorporated herein by this reference. The Statement of Work shall contain a timetable for completion of the Work or if the Work is an ongoing service, the Statement of Work shall set forth the mutually agreed schedule for providing such services. Provider shall use its best efforts to complete all phases of the Work according to such timetable. In the event that there is any delay in completion of the Work arising as a result of a problem within the control of District, Provider and District shall cooperate with each other to work around such delay. However, District shall not be responsible for any additional cost or expense to Provider as a result of such delay unless specifically agreed to in writing by the District. In addition to the specifications and/or requirements contained in the Statement of Work and any warranty given by Provider hereunder, the Statement of Work may set forth those

performance criteria agreed between District and Provider whereby the District can evaluate whether Provider has satisfactorily completed the Work (“Performance Criteria”).

Provider, at Provider’s sole cost and expense, shall furnish all tools, equipment, apparatus, facilities, transportation, labor, and material necessary to meet its obligations under this Agreement. No substitutions of materials or service from those specified in this section shall be made without the prior written consent of the District.

5. **TIME OF PERFORMANCE.** The term of this Agreement shall commence on July 1, 2022, and terminate on August 15, 2022. All work and services contracted for under the terms of this Agreement shall be undertaken and completed in such sequence as to assure their full completion in accordance with the terms and conditions set forth in this Agreement.

6. **PAYMENT AND EXPENSES.** All payments due to Provider are set forth in the “Schedule of Fees” attached hereto and incorporated herein by this reference.

Provider shall send District periodic statements indicating Provider’s fees and costs incurred and their basis and any current balance owed. If no Provider’s fees or costs are incurred for a particular time period, or if they are minimal, the statement may be held by the Provider and combined with that for the following time period unless a statement is requested by the District.

All payments due Provider are set forth in “Schedule of Fees” and shall be paid by the District within 30 days of receipt of a proper invoice from Provider, which invoice shall set forth in reasonable detail the services performed. The District reserves the right, in its sole and absolute discretion, to reject any invoice that is not submitted in compliance with the District’s standards and procedures. In the event that any portion of an invoice submitted by a Provider to the District is disputed, the District shall only be required to pay the undisputed portion of such invoice at that time, and the parties shall meet to try to resolve any disputed portion of any invoice.

The rates set forth in “Schedule of Fees” are not set by law, but are negotiable between Provider and District.

7. **ASSIGNMENT AND SUBCONTRACTORS.** Provider shall not assign, sublet, or transfer this Agreement or any rights under or interest in this Agreement without the prior written consent of the District, which may be withheld by the District in its sole and absolute discretion for any reason. Nothing contained herein shall prevent Provider from employing independent associates, subcontractors, and subconsultants as Provider may deem appropriate to assist in the performance of services herein, subject to the prior written approval of the District. Any attempted assignment, sublease, or transfer in violation of this Agreement shall be null and void, and of no force and effect. Any attempted assignment, sublet, or transfer in violation of this Agreement shall be grounds for the District, in its sole discretion, to terminate the Agreement

8. **TERMINATION OR AMENDMENT.** This Agreement may be terminated or amended in writing at any time by mutual written consent of all of the parties to this Agreement, and may be terminated by either party for any reason by giving the other party 60 days advance written notice. In the event of cancellation prior to completion of the specified services, all finished or unfinished projects, documents, data, studies, and reports prepared by the Provider under this agreement shall, at the option of the District, become District property. The Provider shall be entitled to receive just and equitable compensation for any satisfactory work completed on such items prior to termination of the Agreement.

The parties to this Agreement shall be excused from performance thereunder during the time and to the extent they are prevented from obtaining, delivering, or performing due to act(s) of God. Satisfactory evidence thereof to the other party is required, provided that it is satisfactorily established that the non-performance is not due to the fault or neglect of the party not performing.

9. **NOTICE.** Any notices required or permitted to be given under this Agreement shall be deemed fulfilled by written notice, demand or request personally served on (with proof of service endorsed thereon, or mailed to, or hereinafter provided) the party entitled thereto or on its successors and assigns. If mailed, such notice, demand, or request shall be mailed certified or registered mail, return receipt requested, and deposited in the United States mail addressed to such party at its address set forth below or to such address as either party hereto shall direct by like written notice and shall be deemed to have been made on the third (3rd) day following posting; or if sent by a nationally recognized overnight express carrier, prepaid, such notice shall be deemed to have been made on the next business day following deposit with such carrier. For the purposes herein, notices shall be sent to the District and the Provider as follows:

Rio School District
District

Attn: Sonya, Lopez Mercado, Ed.D.

1800 Solar Dr., 3rd Floor
Street

Oxnard, CA 93030
City, State, Zip Code

Catalyst Family Inc. dba Catalyst Kids
Provider

Attn: Susan Dumars, President

350 Woodview Ave, Suite 100
Street

Morgan Hill, CA 95037
City, State, Zip Code

10. **WARRANTY.** Provider hereby warrants to District that the Work shall be performed in a professional and workmanlike manner consistent with the highest industry standards. For a period of one (1) year following completion of the Work, Provider shall correct or make arrangements to correct any breach of the warranty for the Work within ten (10) business days of notice from District of same.

11. **ADDITIONAL WORK.** If changes in the work seem merited by the Provider or the District, and informal consultations with the other party indicate that a change is warranted, it shall be processed by the District in the following manner:
- a. A letter outlining the changes shall be forwarded to the District by the Provider with a statement of estimated changes in fee and/or time schedule.
 - b. A written amendment to this Agreement shall be prepared by the District and executed by all of the parties before any performance of such services or the District shall not be required to pay for the increased cost incurred for the changes in the scope of work.

Any such amendment to the Agreement shall not render ineffective or invalidate unaffected portions of this Agreement.

12. **COMPLIANCE WITH LAWS.** Provider hereby agrees that Provider, officers, agents, employees, and subcontractors of Provider shall obey all local, state, and federal laws and regulations in the performance of this Agreement, including, but not limited to minimum wages laws and/or prohibitions against discrimination.

Provider, officers, agents, employees and/or subcontractors of Provider shall secure and maintain in force for the full term of this Agreement, at Provider's sole cost and expense, such licenses and permits as are required by law, in connection with the furnishing of all the Services, materials, or supplies necessary for completion of the Services described.

Provider shall be responsible for all costs of clean up and/or removal of spilled regulated substances as a result of Provider's services or operations performed under this Agreement, including, but not limited to:

- Hazardous and toxic substances,
- Hazardous waste,
- Universal waste,
- Medical waste,
- Biological waste,
- Sharps waste.

13. **PREVAILING WAGE.** Provider shall comply with the California Labor Code regarding the payment of the general prevailing per diem wage rates for public work (construction) projects of more than one thousand dollars (\$1,000).

14. **NON-DISCRIMINATION AND EQUAL EMPLOYMENT OPPORTUNITY**

Provider represents and agrees that it does not and shall not discriminate against any employee or applicant for employment because of race, religion, color, sex, or national origin.

15. **INDEMNIFICATION.** Provider agrees to defend, indemnify, and hold harmless District, its officers, agents, employees, and/or volunteers from any and all claims, demands, losses, damages and expenses, including legal fees and costs, or other obligations or claims arising out of any liability or damage to person or property, or any other loss, sustained or claimed to have been sustained arising out of activities of the Provider or those of any of its officers, agents, employees, or subcontractors of Provider, whether such act or omission is authorized by this Agreement or not. Provider shall also pay for any and all damage to the Real and Personal Property of the District, or loss or theft of such Property, done or caused by such persons. District assumes no responsibility whatsoever for any property placed on District premises by Provider, Provider's agents, employees or subcontractors. Provider further hereby waives any and all rights of subrogation that it may have against the District. The provisions of this Indemnification do not apply to any damage or losses caused solely by the negligence of the District or any of its officers, agents, employees, and/or volunteers.
16. **INSURANCE.** Provider, at its own cost and expense, shall procure and maintain during the term of this Agreement, policies of insurance for the following types of coverage:

- ✓ **Workers' Compensation Insurance.** Provider shall procure and maintain, during the term of this Agreement, Workers' Compensation Insurance, as required by California law, on all of its employees engaged in work related to the performance of this Agreement. In the case of any such work which is subcontracted, Provider shall require all subcontractors to provide Workers' Compensation Insurance for all of the subcontractor's employees to be engaged in such work unless such employees are covered by the protection afforded by the Provider's Workers' Compensation Insurance.

- ✓ **Commercial General Liability Insurance.** Provider shall procure and maintain, during the term of this Agreement, not less than the following General Liability Insurance coverage:

	Each Occurrence	Aggregate
Individual, Sole Proprietorship, Partnership, Corporation, or Other	\$ 1,000,000.00	\$ 2,000,000.00
High risk events or activities	\$ 2,000,000.00	\$ 4,000,000.00
Severe risk events or activities	\$ 5,000,000.00	\$ 10,000,000.00

Commercial General Liability insurance shall include products/completed operations, broad form property damage, and personal and advertising injury coverage.

Any and all subcontractors hired by Provider in connection with the Services described in this Agreement shall maintain such insurance unless the Provider's insurance covers the subcontractor and its employees.

- ✓ **Automobile Liability.** If vehicles will be driven on district property, Provider shall procure and maintain, during the full term of this Agreement following Automobile Liability Insurance with the following minimum coverage limits:

Personal vehicles: \$ 500,000.00 combined single limit or
\$100,000.00 per person / \$300,000.00 per accident

Commercial vehicles: \$1,000,000.00 combined single limit

Student Transportation \$5,000,000.00 combined single limit

Provider's and any and all subcontractor's Commercial Automobile Liability Insurance shall name the District, its employees, and school board members as additional insureds.

- ✓ Errors and Omissions Insurance. Provider shall procure and maintain, during the term of this Agreement, Professional Liability/Errors and Omissions Insurance in an amount of not less than the following:

Accountants, attorneys, education consultants, nurses, therapists	\$1,000,000.00
Architects	\$1,000,000.00 or \$2,000,000.00
Physicians and medical corporations	\$5,000,000.00

- ✓ Other Coverage as Dictated by the District. Provider shall procure and maintain, during the term of this Agreement, the following other Insurance coverage:

	Each Occurrence	Aggregate
<input type="checkbox"/> Abuse and Molestation	\$ 1,000,000.00	\$2,000,000.00
<input type="checkbox"/> Pollution Liability	\$ 1,000,000.00	\$ 2,000,000.00
<input type="checkbox"/> Other: _____	\$ _____	\$ _____

Certificates of Insurance. Provider and any and all subcontractors working for Provider shall provide certificates of insurance to the District as evidence of the insurance coverage required herein, not less than Fifteen (15) days prior to commencing work for the District, and at any other time upon the request of the District. Certificates of such insurance shall be filed with the District on or before commencement of the services under this Agreement.

Provider's and any and all Provider subcontractor's Commercial General Liability insurance and Abuse and Molestation coverage shall name the District, its employees, and school board members as additional insureds.

Insurance written on a "claims made" basis is to be renewed by the Provider and all Provider subcontractors for a period of five (5) years following termination of this Agreement. Such insurance must have the same coverage and limits as the policy that was in effect during the term of this agreement, and will cover the provider for all claims made.

Failure to Procure Insurance. Failure on the part of Provider, or any of its subcontractors, to procure or maintain required insurance shall constitute a material breach of contract under which the District may immediately terminate this Agreement.

17. **SAFETY AND SECURITY.** Provider shall be responsible for ascertaining from the District all of the rules and regulations pertaining to safety, security, and driving on school grounds, particularly when children are present.

Certain entities that contract with a school district are required to comply with Education Code section 45125.1 regarding fingerprinting requirements unless the district determines that the Provider will have limited contact with students.

- Provider and any and all subcontractors are required to comply with Education Code section 45125.1, Fingerprint certification requirements. Provider must provide proof that fingerprint certification requirements have been fulfilled prior to commencing any services for the District under this Agreement.
- Provider and its subcontractors are not required to comply with Education Code section 45125.1, Fingerprint certification requirements.
- Transportation Providers are required to comply with Education Code section 49406, Examination for Tuberculosis requirements. Provider must cause to be on file with the District a certificate from the examining physician showing the Provider, employees and/or subproviders of Provider have been examined and found free from active tuberculosis.

18. **PROTECTION OF WORK AND PROPERTY.** Provider and all of its subcontractors shall maintain at all times, as required by conditions and progress of work, all necessary safeguards for the protection of employees and the public. In an emergency affecting life and safety of life or work or of adjoining property, Provider is permitted, without special instruction or authorization from the District, to act at its discretion to prevent such threatened loss or injury.

19. **GOVERNING LAW AND VENUES.** Provider hereby acknowledges and agrees that District is a public entity, which is subject to certain requirements and limitations. This Agreement and the obligations of District hereunder are subject to all applicable federal, state and local laws, rules, and regulations, as currently written or as they may be amended from time to time.

This Agreement shall be interpreted in accordance with the laws of the State of California. If any action is brought to interpret or enforce any term of this Agreement, the action shall be brought in state or federal court situated in the County of Ventura, State of California. Provider hereby waives and expressly agrees not to assert, in any way, any claim or allegation that it is not personally subject to the jurisdiction of the courts named above.

Provider further agree to waive any claim or allegation that the suit, action, or proceeding is either brought in an inconvenient forum or that the related venue is improper.”

20. **ARBITRATION.** Any dispute arising under this Agreement, including, without limitation, all disputes relating in any manner to the performance or enforcement of this Agreement shall be resolved by binding arbitration in Ventura County pursuant to the rules of the American Arbitration Association (AAA), as amended or as augmented in this Agreement (the “Rules”). The parties acknowledge that one of the purposes of utilizing arbitration is to avoid lengthy and expensive discovery and allow for prompt resolution of the dispute.

Arbitration shall be initiated as provided by the Rules, although the written notice to the other party initiating arbitration shall also include a description of the claim(s) asserted and the facts upon which the claim(s) are based. Arbitration shall be final and binding upon the parties and shall be the exclusive remedy for all claims subject hereto, including any award of attorneys’ fees and costs. Either party may bring an action in court to compel arbitration under this Agreement and to enforce an arbitration award.

All disputes shall be decided by a single arbitrator. The arbitrator shall be selected by mutual agreement of the parties within 30 days of the effective date of the notice initiating the arbitration. If the parties cannot agree on an arbitrator, then the complaining party shall notify the AAA and request selection of an arbitrator in accordance with the Rules. The arbitrator shall have only such authority to award equitable relief, damages, costs, and fees as a court would have for the particular claim(s) asserted. In no event shall the arbitrator award punitive damages of any kind.

The arbitrator shall have the power to limit or deny a request for documents or a deposition if the arbitrator determines that the request exceeds those matters, which are directly relevant to the claims in controversy. The document demand and response shall conform to Code of Civil Procedure section 2031. The deposition notice shall conform to Code of Civil Procedure section 2025. The parties may make a motion for protective order or motion to compel before the arbitrator with regard to the discovery, as provided in Code of Civil Procedure sections 2025 and 2031.

21. **ATTORNEYS FEES.** In the event of any action or proceeding to interpret or enforce the terms of this Agreement, the prevailing party, as determined by the court or arbitrator, shall be entitled to recover its reasonable attorneys fees and costs incurred in connection with such actions or proceeding
22. **DOCUMENT RETENTION.** After Provider’s services to District conclude, Provider shall, upon the District’s request, deliver all documents for all matter in which Provider has provided services to the District, along with any property of the District in Provider’s possession and/or control. If the District does not request District’s document(s)t for a particular service, Provider will retain document(s) for a period of two (2) years after the service has ended. If District does not request delivery of the document(s) for the service

before the end of the two (2) year period, Provider will have no further obligation to retain the document(s) and may, at Provider's discretion, destroy it without further notice to the District. At any point during the two (2) year period, District may request delivery of the document(s).

Exceptions: Attorney work-product and medical records shall not be destroyed by provider without the prior written consent of the District.

23. **NATURE OF AGREEMENT.** This Agreement constitutes a binding expression of the understanding of the parties with respect to the services to be provided hereunder and is the sole contract between the parties with respect to the subject matter thereof. There are no collateral understandings or representations or agreements other than those contained herein. This Agreement represents the entire agreement between the parties hereto with respect to the subject matter hereof and supersedes any and all other agreements and communications however characterized, written or oral, between or on behalf of the parties hereto with respect to the subject matter hereof. This Agreement may only be modified by a written instrument signed by authorized representatives of each of the parties hereto.
24. **BINDING EFFECT.** This Agreement shall inure to the benefit and shall be binding upon all of the parties to this Agreement, and their respective successors in interest or assigns.
25. **WAIVER.** No claim or right arising out of a breach of this Agreement can be discharged in whole or in part by a waiver or renunciation of the claim or right unless such waiver is in writing.
26. **SEVERABILITY.** It is intended that each paragraph of this Agreement shall be treated as separate and divisible, and in the event that any paragraphs are deemed unenforceable, the remainder shall continue to be in full force and effect so long as the primary purpose of this Agreement is unaffected.
27. **PARAGRAPH HEADINGS.** The headings of paragraphs hereof are inserted only for the purpose of convenient reference. Such headings shall not be deemed to govern, limit, modify or in any other manner affect the scope, meaning or intent of the provisions of this Agreement or any part or portion thereof, nor shall they otherwise be given any legal effect whatsoever.
28. **AUTHORITY.** Provider represents and warrants that Provider has all requisite power and authority to conduct its business and to execute, deliver, and perform this Agreement. Each party warrants that the individuals who have signed this Agreement have the legal power, right, and authority to make this Agreement and to bind each respective party.
29. **COUNTERPART EXECUTION: ELECTRONIC DELIVERY.** This Agreement may be executed in any number of counterparts which, when taken together, shall constitute one and the same instrument. Executed counterparts of this Agreement may be delivered by

PDF email or electronic facsimile transmission, and shall have the same legal effect as an "ink-signed" original.

IN WITNESS WHEREOF, the parties have executed this agreement as of the date first written above.

Rio School District
District
By: _____
Signature Date

Wael Saleh
Name

Asst. Supt. Of Business Services
Title

Catalyst Family Inc. dba Catalyst Kids
Provider
Susan Dumars 6/8/22
Signature Date

Susan Dumars
Name

President
Title

Approved as to form:

Signature Date

Name
District Counsel

STATEMENT OF WORK

DESCRIPTION OF WORK:

Provider will partner with District in the Expanded Learning Opportunities Program (ELO-P) to provide a summer PreK STEAM Camp for incoming TK and Kindergarten (K) students. The Provider's programs will be offered at Rio Real and Rio Rosales school sites. The ELO-P will engage student participants in activities that promote collaboration and introduce students to a variety of age-appropriate experiences.

The TK/Kindergarten program provides a balanced approach of play and academics. Staff use child guided inspiration to support learning, taking their cues from children's interest and expanding into activities and projects. Provider TK/K personnel will meet with District teachers to discuss goals, strengths, and challenges as it relates to the children attending and build adult guided experiences to complement school day learning.

The Provider shall specifically ensure, in part, that all Professional Staff who directly supervise pupils meet the minimum qualifications to serve as an Instructional Aide in the District, 48 passing units in related fields or pass the district's Instructional Assistant Exam. The District human resources department will administer the "Instructional Assistant Examination" for the expanded learning program staff hiring pool and will provide verification to Provider for their hiring process.

Under the agreement, Provider will:

- Provide a summer camp-style STEAM program in conjunction with Summer Jump Start instructional minutes to equal at least 9 hours of care on each operating school day.
- Serve a nutritious lunch and snack daily provided by the District
- Record student attendance and submit to the District
- Maintain a 10:1 adult to student ratio per Expanded Learning Opportunities Programs assurances

The District will:

- Submit names of students on interest list to Provider
- Administer Instructional Assistant Examination to staff
- Provide learning spaces on District campuses
- Provide nutritious lunch and snack during STEAM program hours
- Notify families of admission to the program
- Enroll and report student attendance in Q information system

WORK SCHEDULE:

Program dates: July 6, 2022-July 29, 2022 (Monday-Friday)

Program hours: 11:30am -5:30pm

Locations: Rio Real, Rio Rosales, one location TBD

SCHEDULE OF FEES

FEES:

Total Amount Not To Exceed

\$ 45,400

Provider shall submit an invoice with expenses for Services provided under this Agreement. All expenses under this Agreement are to cover the costs associated with children enroll, up to 20 children at each location, into the ELO-P referred by the District. The total invoice not to exceed the agreed amount of \$45,400, including administrative fee.

PAYMENT SCHEDULE:

Provider will invoice District by the 20th of August 2022. The invoice will include the following support items:

- The Enrollment and Attendance report per Site (Location)
- The final P&L report with itemized expenses for all three locations.
- Administrative Fees/Expenses equivalent to 5% of total cost (included in the final P&L)



Agenda Item Details

Meeting	Jun 29, 2022 - RSD Regular Board Meeting
Category	9. Consent
Subject	9.18 Lease Agreement with Catalyst Family Inc. for Preschool Services
Access	Public
Type	Action (Consent)
Fiscal Impact	No
Budgeted	No
Budget Source	Not applicable
Recommended Action	Staff recommends board approval of the Catalyst Preschool Services contract for 2022-2023 school year.
Goals	Goal 1-Improved student achievement at every school and every grade in all content areas

Public Content

Speaker: Oscar Hernandez, Assistant Superintendent Educational Services

Rationale:

The lease agreement with Catalyst Family, Inc. helps provide preschool opportunities to children living within the boundaries of the Rio School District and allows for the social and academic development of students who will enroll in the Rio School District.

Catalyst Family, Incorporated, has provided preschool opportunities at three RSD campuses- Rio del Mar, Rio del Norte, and Rio Real- for a total of 54 full-day slots, 144 half-day slots, and 30 after school care slots (K-2 at Rio Real only).

[Catalyst Rio SD 2022-23 Lease.docx.pdf \(212 KB\)](#)

Administrative Content

Executive Content

Our adopted rules of Parliamentary Procedure, Robert's Rules, provide for a consent agenda listing several items for approval of the Board by a single motion. Most of the items listed under the consent agenda have gone through Board subcommittee review and recommendation. Documentation concerning these items has been provided to all Board members and the public in advance to assure an extensive and thorough review. Items may be removed from the consent agenda at the request of any board member.

**CATALYST FAMILY INCORPORATED
LEASE AGREEMENT**

This is an agreement between the **Rio School District**, hereinafter referred to as **DISTRICT**, and Catalyst Family Incorporated, hereinafter referred to as **CATALYST FAMILY INC.** The parties hereto agree as follows:

1. **TERM.** The term of this agreement shall commence on July 1, 2022, and shall continue through June 30, 2023, during which time the CONTRACTOR shall perform the services required under this agreement.
2. **SERVICE PROVISIONS.**
 - 2.1 Program Description
 - 2.2 Program Goal
 - 2.3 Activities and Service with outcomes and measurement instruments.
3. **FACILITIES AND CUSTODIAL COST.** SUBCONTRACTOR will contract and/or provide its own custodial services. DISTRICT will not bill SUBCONTRACTOR for expenses to help cover facilities and custodial costs incurred by the District
4. **RENT.** SUBCONTRACTOR shall pay to the DISTRICT the total for rent for the lease term of One dollar (\$1.00) per year payable annually on or before August 1, 2022. The difference between the actual value of the property and the \$1.00 rent will be used as an In-Kind donation. The Rio School District will provide SUBCONTRACTOR with a value statement indicating the actual value of the classroom being utilized
5. **INVESTIGATION AND RESEARCH.** SUBCONTRACTOR by investigation and research has acquired reasonable knowledge of all conditions affecting the work to be done and labor and material needed, and the execution of this contract is to be based upon such investigation and research, and not upon any representation made by the DISTRICT, any of its offices, or employees, except as provided herein.
6. **SUBCONTRACTOR.** No relationship of employer and employee is created in this agreement, it being understood that the SUBCONTRACTOR is a SUBCONTRACTOR. None of the persons performing services for SUBCONTRACTOR pursuant to this agreement, whether said person is a member, partner, employee, contractor, or otherwise, shall have any claim under this agreement or otherwise against DISTRICT for sick leave, vacation pay, retirement benefits, social security, workers' compensation, disability, unemployment insurance benefits, or employee benefits of any kind.

DISTRICT is not required to make any deductions for any third party from the compensation payable to SUBCONTRACTOR under the provisions of this agreement. SUBCONTRACTOR hereby holds DISTRICT harmless from any and all claims that

may be made against DISTRICT based upon any contention by any third party that any employer-employee relationship exists by reason of this agreement.

It is further understood and agreed by the parties hereto that SUBCONTRACTOR in the performance of its obligation hereby is subject to the control of director of DISTRICT only as to the results to be accomplished by the services hereunder agreed to be rendered and performed and not to the means and methods for accomplishing the results.

If, in the performance of this agreement, any third persons are employed by the SUBCONTRACTOR, such persons shall be entirely and exclusively under direction, supervision, and control of the SUBCONTRACTOR. All terms of employment, including hours, wages, working conditions, discipline, hiring and discharging or any other terms of employment or requirements of law, shall be determined by SUBCONTRACTOR and comply with all statutory requirements.

7. **CONTRACTOR'S EMPLOYEES.** SUBCONTRACTOR agrees that all SUBCONTRACTOR employees have secured or shall secure at SUBCONTRACTOR's own expense all persons and employees and that all such services shall be performed by SUBCONTRACTOR or under SUBCONTRACTOR's supervision by persons authorized by law to perform such services.
8. **EQUIPMENT.** Equipment required to perform the services required under this Agreement will be provided by the DISTRICT and remain the property of the DISTRICT.
9. **EQUAL OPPORTUNITY.** SUBCONTRACTOR will not discriminate against any employee, or against any applicant for such employment because of age, race, color, religion, physical handicap, ancestry, gender, or national origin. This provision shall include, but not limited to, the following: employment, upgrading, demotion, or transfer, recruitment or recruitment advertising, layoff or termination; rates of pay or other forms of compensation; and selection for training, including apprenticeship.
10. **PERSONNEL DISCLOSURE.** SUBCONTRACTOR shall make available to DISTRICT a current list of all personnel providing services under this agreement. Changes to this list shall be immediately provided to DISTRICT in writing. The list shall include: (1) all full or part time staff positions by title, including volunteer positions whose direct services are required to provide the services described herein, (2) a brief description of the functions of each such position and the hours each position works each week or, for part-time positions, each day or month, as appropriate, (3) the professional degree, if applicable, and experience required for each position, and (4) the name of the person responsible for fulfilling the terms of this agreement.
11. **RESPONSIBILITY FOR EQUIPMENT.** DISTRICT shall not be responsible nor held

liable for any damage to person or property consequent upon the use, misuse, or failure of any equipment used by SUBCONTRACTOR or any of SUBCONTRACTOR's employees, even though such equipment is furnished, rented, or loaned to SUBCONTRACTOR by DISTRICT. The acceptance or use of any such equipment by SUBCONTRACTOR or SUBCONTRACTOR's employees shall be construed to mean that SUBCONTRACTOR accepts full responsibility for and agrees to exonerate, indemnify and hold harmless DISTRICT from and against any and all claims for any damage whatsoever resulting from the use, misuse, or failure of such equipment.

12. **INDEMNIFICATION AND HOLD HARMLESS.** All activities and work covered by this Agreement shall be at the risk of the SUBCONTRACTOR. SUBCONTRACTOR agrees to defend, indemnify and hold harmless the DISTRICT, including all of its committee members, employees, agents and volunteers against any and all claims or lawsuits, judgments, debts, demands and liability whether against SUBCONTRACTOR, DISTRICT or others, including those arising from injuries or death of persons and for damages to property, arising directly or indirectly out of the obligations herein described or undertaken or out of operations conducted or subsidized in whole or in part by SUBCONTRACTOR, save and except claims or litigation arising through the negligence or wrongdoing, or the willful misconduct of the DISTRICT.

13. **INSURANCE.** SUBCONTRACTOR at its sole cost and expense, shall obtain and maintain in full force during the term of this agreement the following types of insurance.

13.1 Commercial General Liability "occurrence" coverage in the minimum amount of \$1,000,000 combined single limit (CSL) bodily injury and property damage each occurrence and \$1,000,000 aggregate, including personal injury, broad form property damage, products/completed operations, broad form blanket contractual, and \$50,000 fire legal liability, if applicable.

13.2 Commercial Automobile Liability coverage in the minimum amount of \$1,000,000 CSL bodily injury and property damage, including owned, non-owned and hired automobiles.

13.3 Workers' Compensation coverage in full compliance with California Statutory Requirements for all employees of the SUBCONTRACTOR and Employer's Liability in the minimum amount of \$1,000,000.

13.4 Professional Liability coverage in the minimum amount of \$1,000,000 each occurrence and in the aggregate.

13.5 All insurance required under this agreement shall be primary coverage as respects to the DISTRICT, and any insurance or self-insurance maintained by the DISTRICT shall be in excess of the SUBCONTRACTOR's insurance coverage and shall not contribute to the SUBCONTRACTOR's coverage. DISTRICT is to be notified

immediately if any aggregate insurance limit is exceeded. Additional coverage must be purchased to meet requirements.

13.6 The DISTRICT is to be named as ADDITIONAL INSURED as respects to work done by SUBCONTRACTOR under the terms of this agreement on all policies required. However, this paragraph 2.7.3 shall not be construed to apply to Workers' Compensation coverage.

13.7 Policies shall not be cancelled, non-renewed or reduced in scope of coverage until after sixty (60) days written notice has been given to the DISTRICT.

13.8 SUBCONTRACTOR agrees to provide DISTRICT with the following insurance documents within fourteen (14) days after the execution of this agreement.

13.8.1 Certificates of Insurance for coverage required under this agreement.

13.8.2 Additional insured endorsements; and

13.8.3 Sixty (60) days Notice of Cancellation Clause endorsements except for nonpayment of premium

13.9 Failure to timely provide these documents shall be grounds for immediate termination or suspension of this agreement.

13.10 It is the responsibility of the SUBCONTRACTOR to confirm that all terms and conditions of the insurance provisions are complied with and all subcontractors that the SUBCONTRACTOR may use for the completion of this agreement.

13.11 Insurance coverage in the minimum amounts set forth herein shall not be construed to relieve the SUBCONTRACTOR for liability in excess of such coverage, nor shall it preclude the DISTRICT from taking such other actions as are available to it under any other provisions of this agreement or otherwise in law.

13.12 If the Professional Liability Coverage is "claims made," SUBCONTRACTOR must, for a period of three (3) years after the date when the agreement is terminated, completed, or non-renewed, maintain insurance with a retroactive date that is on or before the start date of the agreement services or purchase an extended reporting period endorsement (tail coverage). DISTRICT may withhold final payments due until SUBCONTRACTOR provides satisfactory evidence of the tail coverage to DISTRICT.

14. ASSIGN ABILITY. SUBCONTRACTOR shall not assign any interest in this agreement, and shall not transfer any interest in the same, whether by assignment or novation, without the prior written consent of DISTRICT thereto; provided, however, that claims for money due or to become due to SUBCONTRACTOR from DISTRICT under this agreement may be assigned without such approval. Notice of any such assignment or transfer shall be furnished promptly to DISTRICT.

15. **SUBCONTRACTS.** Functions undertaken by the SUBCONTRACTOR may be carried out under subcontracts. However, SUBCONTRACTOR may not delegate its duties or obligations nor assign its rights hereunder, either in whole or in part, without prior written consent of DISTRICT. Any such attempted delegation or assignment without prior consent shall be void. Any change whatsoever in the corporate structure of SUBCONTRACTOR or the transfer of assets in excess of ten (10) percent of the total assets of SUBCONTRACTOR shall be deemed an assignment of benefits under the terms of this agreement requiring DISTRICT approval.

All subcontracts shall be in writing and copies provided to DISTRICT. No subcontract shall alter in any way any legal responsibility of SUBCONTRACTOR to DISTRICT. All subcontractors will be provided a copy of this agreement, and any subcontract must state that any work performed must be consistent with this agreement. DISTRICT has the right to refuse reimbursement for obligations incurred under any subcontract, which do not comply with the terms of this agreement.

In each subcontract, SUBCONTRACTOR shall include all provisions that the DISTRICT may require. DISTRICT shall make these provisions available to SUBCONTRACTOR.

16. **POLITICAL ACTIVITIES PROHIBITED.** None of the funds, provided directly or indirectly, under this agreement shall be used for any political activities or to further the election or defeat of any candidate for public office. Neither the contract nor any funds provided hereunder shall be utilized in support of any partisan political activities, or activities for or against the election of a candidate for an elected office.
17. **RELIGIOUS ACTIVITIES PROHIBITED.** There shall be no religious worship, instructions or proselytization as part of, or in connection with the performance of this agreement. Active participation in religious worship or instruction cannot be a prerequisite for individuals receiving services utilizing Proposition 10 dollars. Expenditures of Proposition 10 dollars for religious services and practices are specifically prohibited. SUBCONTRACTOR must indicate how unlawful expenditures of Proposition 10 dollars for religious services and practices are to be avoided. Any religious indoctrination or encouragement incidental to the delivery of services under the application is strictly prohibited.
18. **LICENSES AND STANDARDS.** SUBCONTRACTOR shall conform with all federal, state, county and local rules and regulations, including facility and professional licensing and certification laws and shall keep in effect any and all licenses, permits, notices and certificates as are required for the duration of this agreement. SUBCONTRACTOR shall further comply with all laws applicable to wages and hours of employment, occupational safety, and fire safety, health and sanitation.

In the performance of this agreement, SUBCONTRACTOR shall comply with all applicable provisions of the California Welfare and Institutions Code, Title 45 of the Code of Federal Regulations, all applicable laws and regulations of the United States, State of California, and DISTRICT and all administrative regulations, rules and policies adopted hereunder that are applicable as identified by the scope of this agreement as each and all may now exist or be hereinafter amended or changed. In addition, SUBCONTRACTOR shall comply with all rules and regulations set forth in Federal Office of Management and Budget (OMB) Circular A-122 (cost principles for nonprofit organizations) or OMB Circular A-21 (cost principles for educational institutions) or OMB Circular A-87 (cost principles for state and local governments) as applicable to form of entity by which SUBCONTRACTOR transacts its business.

19. **MAINTENANCE OF RECORDS.** SUBCONTRACTOR agrees to maintain all records pertaining to service delivery and fiscal and administrative control for five (5) years after final payment has been made, or until all pending DISTRICT, state, or federal audits are completed, whichever is later. Upon request, SUBCONTRACTOR shall make these records available within Ventura County to all authorized DISTRICT, state (including Auditor General) and federal personnel.

20. **CUSTODY OF RECORDS.** At its option, DISTRICT may take custody of SUBCONTRACTOR's client records related to services provided under this agreement upon agreement termination. DISTRICT agrees that such custody shall conform to applicable confidentiality provisions of state and federal law. Said records shall be kept by DISTRICT in an accessible location within Ventura County and shall be available to SUBCONTRACTOR for examination and inspection.

21. **FISCAL AND PERFORMANCE AUDITS AND INSPECTION OF RECORDS.** Authorized federal, state, or county representatives shall have the right to monitor, assess, or evaluate SUBCONTRACTOR's performance in accordance with federal and state laws and regulations. The monitoring, assessments, or evaluations may include but are not limited to audits, inspection of premises, reports, and interviews of program staff and participants.

At any time during normal business hours, and as often as DISTRICT may deem necessary, SUBCONTRACTOR shall make available to DISTRICT, state, federal or county officials for examination, all records pertaining to all matters covered by this agreement and shall permit county, state or federal officials to audit, examine and make excerpts or transcripts from such records, and to make audits of all invoices, materials, payrolls, records of personnel, information regarding clients receiving services, and other data relating to all matters covered by this agreement.

22. DISTRICT shall have the right to review the work being performed by the SUBCONTRACTOR under this contract at any time during DISTRICT's usual working hours. Review, checking, approval or other action by DISTRICT shall not relieve

SUBCONTRACTOR of SUBCONTRACTOR's responsibility for the accuracy and completeness of the work performed under this contract.

23. **CHILD ABUSE REPORTING.** SUBCONTRACTOR shall require all employees, volunteers, SUBCONTRACTORS, or agents performing services under this agreement who are required by Section 11166, Subdivision (a), of the Penal Code to report child abuse or neglect or are required by Section 15630 of the Welfare and Institutions Code to report elder or dependent adult abuse or neglect, to sign a statement that he or she understands the reporting requirements and will comply with them.
- 22.1. SUBCONTRACTOR shall establish procedures to ensure the reporting of child abuse and neglect and elder or dependent adult abuse and neglect by all employees, volunteers, SUBCONTRACTOR's, or agents who gain knowledge of, or reasonably suspect that a child, elder or dependent adult has been a victim of abuse or neglect, even when such persons are **not** otherwise required by Section 11166, Subdivision (a), of the Penal Code or Section 15630 of the Welfare and Institutions Code, to report such abuse or neglect.
24. **TERMINATION. TERMINATION.** DISTRICT retains the right to terminate this contract for any reason prior to completion by notifying SUBCONTRACTOR in writing and by paying charges accumulated prior to such termination. On completion or termination of contract, DISTRICT shall be entitled to immediate possession of and SUBCONTRACTOR shall furnish all computations, programs, correspondence and other pertinent data gathered or computed by SUBCONTRACTOR for this particular project prior to any termination. SUBCONTRACTOR hereby expressly waives any and all claims for damages or compensation arising under this contract, except as set forth in this paragraph, in the event of such termination.
25. **ADDENDA.** DISTRICT may from time to time require changes in the scope of the services required hereunder. Such changes, including any increase or decrease in the amount of SUBCONTRACTOR's compensation which are mutually agreed upon by and between DISTRICT and SUBCONTRACTOR, shall be effective when incorporated in written amendments to this agreement.
26. **CONFLICT OF INTEREST.** SUBCONTRACTOR covenants that SUBCONTRACTOR presently has no interest, including, but not limited to, other projects or independent contracts, and shall not acquire any such interest, direct or indirect, which would conflict in any manner or degree with the performance of services required to be performed under this agreement. SUBCONTRACTOR further covenants that in the performance of this agreement, no person having such interest shall be employed or retained by SUBCONTRACTOR under this agreement.
27. **CONFIDENTIALITY.** Any reports, information, data, statistics, forms, procedures, systems, studies, and any other communication or form of knowledge given to or prepared or assembled by SUBCONTRACTOR under this agreement in which the DISTRICT requires to be kept as confidential shall not be made available to any

individual or organization by SUBCONTRACTOR without the prior written approval of DISTRICT, except as authorized by law.

SUBCONTRACTOR shall insure that SUBCONTRACTOR's employees and/or independent SUB-CONTRACTOR or agents shall keep such confidential information confidential.

28. **NOTICES.** All notices made under this agreement shall be made in writing and addressed or delivered as follows:

TO DISTRICT: Rio School District
Attn: Sonya Lopez Mercado
1800 Solar Dr., 3rd Floor
Oxnard, CA 93030
(805) 485-3111

SUBCONTRACTOR: Catalyst Family Incorporated
350 Woodview Ave., Suite 100
Morgan Hill, CA 95037 (916)
830-3342

Either party may, by written notice to the other, change its own mailing address, and shall promptly notify the other party in writing.

29. **ENTIRE AGREEMENT.** The terms and conditions set forth in the attached exhibits hereto are incorporated herein by this reference. This agreement contains all terms and conditions agreed upon by DISTRICT and SUBCONTRACTOR and no other understanding, oral or otherwise, regarding this agreement shall be deemed to bind any of the parties of this agreement.

IN WITNESS THEREOF, DISTRICT and SUBCONTRACTOR have executed this agreement on the dates indicated below.

DISTRICT

CATALYST FAMILY INC.

John D. Puglisi

Ph.D. Superintendent

Susan Dumars

President

Date

Date

SUBCONTRACT ADDENDA

This is an "Amendment" to the original agreement between the **Rio School District**, hereinafter referred to as **DISTRICT**, and **Catalyst Family Incorporated**, hereinafter referred to as **SUBCONTRACTOR**.

Coronavirus disease 2019 (COVID-19) is a respiratory illness that can spread from person to person. The parties enter into the following agreement in response to ongoing health concerns presented by the COVID-19 virus:

1. The parties will communicate updated policies within each organization as they are developed and distributed.
2. Clear communication will be sent to the school district if an employee or child has tested positive for COVID-19.
3. SUBCONTRACTOR agrees to adhere to all state and federal COVID-19 return to work protocols.
4. SUBCONTRACTOR will implement the following protocols and procedures to ensure the health and safety of children and employees

Health Screening for Children and Staff:

- Temperature of anyone who enters the facility is taken upon arrival.
- Temperature log indicates "Yes" or "No" for a high temperature
- Families and staff are asked if they have been exposed to COVID-19, daily.
- Any child or staff member that shows signs of illness is immediately sent home.

Parent Sign in and Out Procedures:

- Parents sign in and out outside of the facility using their own pen or a disinfected pen provided by the site.
- Parents do not enter the classroom and are met by staff at the sign in/out gate

Face Coverings:

- Face coverings are required for adults at all times. Six feet of social distancing is also maintained with other adults at all times

- For children over the ages of two, face coverings are recommended when they are not able to maintain 6-feet physical distancing from both adults and children.
- Mask and/or face shields may also be worn. Face coverings are strongly encouraged for young children between two years old and second grade, if they can be worn properly. A face shield is an acceptable alternative for children in this cohort.
- Face coverings are worn by children in 3rd grade and above

Sanitizing and Disinfecting Protocols:

- Staff clean high touch areas hourly or in-between use.
- Children and staff restrooms are disinfected hourly. Restrooms shared by more than one stable group of children and/or person are disinfected in-between use.
- Signage of protocols in English and Spanish will be posted on the preschool gate near the parking lot

Program adjustments for children:

- Children have their own materials that they keep in their own container.
- Any shared material is disinfected after each use.
- Increase of outdoor learning and enrichment experiences
- Daily discussions about healthy behaviors and practices.
- Provide families with videos and written information with COVID- 19 facts.
- Complete weekly check-ins with families who are not able to attend.
- Maximum of 12 children in each Preschool and School-Age classroom (or as state and local guidance allows)
- Increased individual play and parallel play when engaging in conversation
- Increased non-touch outdoor activities with equipment disinfected after each use

Food Service:

- Meals will continue to be provided by Rio School District
- Family style service will be suspended and substituted with individualized meal service as per USDA and people will sit 6 feet apart of one another.

5. HOURS OF OPERATION

Monday-Friday, 7:00am-6:00pm

6. REOPENING PLANS.

SUBCONTRACTOR will pilot a reopening at the Rio Real School while DISTRICT is involved in distance learning. The center will have one Preschool classroom and one School-Age classroom. This program provides full-day child care for working families and supports with distance learning. Enrollment for the School-Age program will be provided to the lowest income families first, then to families who have been enrolled the longest. Enrollment for the Preschool program will be provided to the lowest income four-year-olds, then to the lowest income three-year-olds.

Once DISTRCT students return to campus, SUBCONTRACTOR will return to remaining sites at Rio del Norte Elementary and Rio Del Mar School.

If DISTRCT extends distance learning, SUBCONTRACTOR may reopen one site at a time. Communication regarding COVID data will be provided to DISTRCT on a consistent basis.

SUBCONTRACTOR will collaborate with site administrators of DISTRCT on ingress and egress of the Preschool program.

DISTRCT

CATALYST FAMILY INC.

John D. Puglisi

Ph.D. Superintendent

Susan Dumars

President

Date

Date

Catalyst Cleaning, Sanitizing, and Disinfecting Schedule

Areas	Before Each Use	After Each Use	Daily-End of Day	Weekly	Comments
Food Preparation Surfaces	Clean & Sanitize	Clean & Sanitize			Use Oxivir-Tb or EPA registered household Surfaces Sanitize Sanitize bleach at ½ teaspoon /1 qt cool water. If using OxivirTb, all food contact surfaces must be rinsed with potable water.
Eating Utensils & Dishes		Clean & Sanitize			Use 5 Step Method or a dishwasher
Tables Used during meal time and highchair trays	Clean & Sanitize	Clean & Sanitize			Use Oxivir-Tb or EPA registered household bleach at ½ teaspoon/1 qt cool water. If using Oxivir-Tb, all food contact surfaces must be rinsed with potable water
Countertops where food is prepared	Clean & Sanitize	Clean & Sanitize			See Above
Refrigerator				Clean	Clean spills as they occur.
Microwave /stove				Clean	Clean spills as they occur.
Play Areas in classroom-All horizontal surfaces			Clean		All horizontal surfaces should be cleaned daily by janitorial services. When this does not occur, staff need to clean surfaces with a soap and water solution (not a sanitizer or disinfectant).
Computer keyboards mouse			Clean & Disinfect		Spray Oxivir-Tb onto paper first.
Door & Cabinet handles/ phones			Clean & Disinfect		

Catalyst Cleaning, Sanitizing, and Disinfecting Schedule

	Clean & Disinfect before meal time handwashing	Clean & Disinfect		Bathroom sinks used to wash hands before meals
Areas	Before Each Use	After Each Use	Daily-End of Day	Weekly
Kitchen sink also used for handwashing	Clean & Disinfect before food prep		Clean & Disinfect	Before using the kitchen sink to wash dishes, rinse fruits/vegetables or for any other foodprep, the sink must be disinfected for 1 minute using Oxivir-TB and then rinsed with water.
Dramatic play clothes				Launder
Plastic Mouthed toys		Remove from play area	Clean & Sanitize	Sanitize using EPA registered regular household bleach ½ teaspoon/1 qt cool water
Machine Washable Cloth Toys				Launder
Changing Table		Clean & Disinfect	Clean & Disinfect under pad	Use Oxivir-Tb to clean and disinfect after each use. 1 minute contact time on surface. At the end of the day, the surface beneath the changing table pad is cleaned and sanitized.
Potty Chairs		Clean & Disinfect		Use Oxivir-Tb to clean and disinfect after each use. 1 minute contact time on surface.
Bed Sheets, Pillow Cases, Blankets				Launder before use by another child
Cots & Mats				Clean before use by another child
Drinking Fountains		Clean & Disinfect		Drinking fountains used exclusively for CDI-CDC Children are cleaned and disinfected daily.



Cleaning, Sanitizing, and **Disinfecting Schedule**

9.19



Agenda Item Details

Meeting	Jun 29, 2022 - RSD Regular Board Meeting
Category	9. Consent
Subject	9.19 Renewal of lease agreement with First 5 Ventura for the use of spaces in the Office of Student and Family Services
Access	Public
Type	Action (Consent)
Fiscal Impact	No
Budgeted	No
Budget Source	Not applicable

Public Content

Speaker: Oscar Hernandez, Assistant Superintendent Educational Services

Rationale:

First 5 Ventura County (F5VC) is largely funded through Proposition 10, the California Children and Families Act. Passed by the voters of California in 1998, this tobacco tax is dedicated to developing local systems that improve health and education for our youngest Californians, from prenatal through age 5. Governed by a nine-member Commission appointed by the Ventura County Board of Supervisors, F5VC has made a significant, positive impact on early childhood systems in Ventura County. First 5 provides prenatal, parent and child, and parenting education to families residing in the Rio community.

In 2021-2022, First 5 served 46 families and children through age 5 through educational programs and services.

[First 5 Rio SD lease agreement FY 22-23_encrypted_.pdf \(237 KB\)](#)

Administrative Content

Executive Content

Our adopted rules of Parliamentary Procedure, Robert's Rules, provide for a consent agenda listing several items for approval of the Board by a single motion. Most of the items listed under the consent agenda have gone through Board subcommittee review and recommendation. Documentation concerning these items has been provided to all Board members and the public in advance to assure an extensive and thorough review. Items may be removed from the consent agenda at the request of any board member.

LEASE AGREEMENT

THIS LEASE AGREEMENT ("Lease"), is entered as of the 1st day of July, 2022, by and between Rio Unified School District ("Landlord"), and the Children and Families First Commission of Ventura County, known as First 5 Ventura County, ("Tenant") an independent governmental entity, for operation of the Neighborhoods for Learning program (hereinafter referred to as "Program").

1. Property Leased. Landlord hereby leases to Tenant and Tenant hereby rents from Landlord the property located in the City of Oxnard, County of Ventura, State of California, described as follows (the "Premises"):

Classroom/Space:
for exclusive use. 1,144 sq. ft room located at 3300 Cortez Ave
Oxnard, CA 93036.

Shared restroom and Break room area: 522 sq. ft.

Parking lot space, for shared use;
located at located at 3300 Cortez Ave Oxnard, CA 93036.

2. Term.

(a) The term of this Lease is twelve (12) months, commencing July 1, 2022 and ending June 30, 2023.

(b) Notwithstanding the foregoing Section 2(a), Tenant or Landlord may terminate this Lease at any time by delivering written notice to the other party no less than ninety (90) days prior to the effective date of such termination. In the event of termination of this Lease in accordance with this Section 2(b), any rent prepaid by Tenant will be prorated by Landlord and that portion applicable to any period subsequent to the effective date of termination will be returned to Tenant.

3. Rent; Facilities Use Fee. Tenant shall pay to Landlord a facility use fee for the property leased of \$1,466.48 per month. Monthly facility use fee is comprised of \$.75 per square foot for the exclusive use space (1,144 square feet), \$96.00 for the shared usage space, \$248.00 for Tenant's proportional share of utilities as set forth in Paragraph 11(a), and \$264.48 for Tenant's proportional share of janitorial services as set forth in Paragraph 11(b). Tenant shall send the rent payments to landlord on a monthly basis payable before the 5th of each month. Landlord has the right to increase the rent every year for no more than the Consumer Price Index as published by the US Department of Labor - Los Angeles - Long Beach - Anaheim, CA for the 12-month preceding the lease period start date.

4. Holdover. If Tenant fails to vacate and surrender the Premises on or before the expiration date of this Lease, and this Lease is not renewed pursuant to Section 2(a), the tenancy shall, at Landlord's option, be deemed a tenancy from month to month, until the tenancy is terminated in a manner prescribed by law.

5. Use; Program Obligations. The Premises shall be used solely for Tenant's operation of Programs for Early Child and Family Development, Early Literacy and Family Support (i.e. Parent and Child Together Classes, Child Literacy Groups, etc.). The Tenant will provide appropriate furniture, supplies and staff to conduct their activities. The Tenant is responsible for the operation of the program. Tenant shall be responsible for providing all staff, supplies, materials, and any other services or personnel necessary or desirable for Tenant's operation, and Tenant acknowledges that Landlord is not supplying or providing any of the foregoing services or personnel. In addition, Tenant shall be solely responsible for the operation and supervision of staff employed or participating in programs they provide. No other use is permitted without Landlord's prior written consent. Tenant will comply with all applicable laws, ordinances, statutes, regulations and orders (collectively, "Laws") affecting its use of the Premises. Tenant shall not use the Premises to disturb, annoy, endanger, or interfere with others at the School Site, or use the Premises for any unlawful purpose or commit a waste or nuisance on or about the Premises.

6. Signs. Tenant shall have the right to have installed signs appropriate for the identification of the Premises, with approval of the Landlord. Landlord's maintenance staff shall perform sign installation.

7. Condition of Premises. Tenant will examine the Premises and acknowledges that the Premises is clean and in operative condition, prior to lease signing. If noted maintenance need, it will be completed prior to lease or by arrangement with Tenant.

8. Alterations. Tenant shall not make any alterations whatsoever in or about the Premises without Landlord's prior written consent, which shall not be unreasonably withheld. Any alterations to the Premises shall be done in accordance with all applicable Laws and with required permits. Tenant shall give Landlord advance written notice of the commencement date of any planned alteration, so that Landlord, at its option, may post a Notice of Non-Responsibility to prevent potential liens against Landlord's interest in the Premises. Any alterations required by Law as a result of Tenant's use shall be Tenant's responsibility. All improvements installed by Tenant, with or without Landlord's consent, become the property of Landlord upon termination. However, Landlord may require Tenant to remove any such improvement that did not exist at the time possession was made available to Tenant.

9. Parking. Parking is based on a first-come first-serve basis. Tenant is entitled to use unreserved vehicle parking spaces located at the Site. Parking spaces are to be kept clean. No overnight parking is permitted.

10. Insurance. Tenant's personal property, fixtures, equipment, and vehicles are not insured by Landlord against loss or damage due to fire, theft, vandalism, rain, water, criminal or negligent acts of others, or any other cause. Tenant shall carry its own property insurance to protect

Tenant from any such loss. Tenant will be 100% covered before moving into premises and will provide Landlord with a certificate of insurance establishing Tenant's compliance prior to moving into premises. In addition, Tenant shall carry liability insurance in an amount not less than \$1,000,000.00. Tenant's liability insurance shall name Landlord as additional insured. Prior to occupancy the Tenant shall provide Landlord with a certificate of insurance establishing Tenant's compliance. Landlord shall maintain liability insurance insuring Landlord, but not Tenant, in an amount of at least \$1,000,000.00. Both Landlord and Tenant release each other, and waive their respective rights to subrogate against each other, for loss or damage covered by insurance during the term of the agreement.

11. Utilities; Janitorial.

(a) Utilities are pro-rated by square feet. Landlord shall provide for water, sewer, and electrical utilities on the premises unless otherwise negotiated. Tenant shall pay to Landlord the amount set forth in Paragraph 3 for the tenant's share of utilities. Landlord shall make and maintain proper connections with any and all water, gas, sewer, and electrical lines serving the Premises and shall continue the connections and service thereof during the term of this Lease or any extension thereof.

(b) Janitorial services shall be provided by Landlord daily during the term of this Lease. Landlord shall provide janitorial/custodial services at the amount set forth in Paragraph 3 for approximately one hour a day, 3 times a week occurring after 5:00 p.m. if possible. Services shall include wiping down surfaces, vacuuming, and collection of all trash and rubbish material. Tenant shall supply proper containers for trash.

12. Maintenance. Subject to the following sentence, Landlord shall provide custodial services set forth in Paragraph 11b. Tenant will maintain the exclusive use space in a clean and orderly condition, free of all litter, garbage, debris and refuse, including keeping glass, windows and doors in operable and safe condition. Landlord, at its sole cost, shall maintain the electrical, heating, ventilation, air conditioning, plumbing, roof, foundation, exterior walls, and other common areas at the Site, Tenant shall be responsible for any maintenance which may be required by reason of neglect or misconduct of Tenant, its agents, servants, employees, invitees or contractors.

13. Entry by Landlord. Landlord may enter upon the classroom portion of the Premises at all reasonable times to examine the condition thereof, and for the purpose of providing maintenance and cleaning and making such repairs as Landlord is obligated to make provided that such right shall not be exercised in such a manner as to unreasonably interfere with any business conducted by Tenant on the Premises.

14. Subletting and Assignment. Tenant shall not sublet or assign or transfer this Lease or any interest in it without the prior written consent of Landlord, which shall not be unreasonably withheld. Unless such consent is obtained, any subletting, assignment, transfer or encumbrance of the Premises is null and void, and, at the option of Landlord, terminates this Lease. No sublease, assignment or transfer of this Lease shall relieve Tenant with respect to any liabilities and obligations hereunder. The consent by Landlord to an assignment hereunder shall not in any way

be construed to relieve Tenant from obtaining the express written consent of Landlord to any further assignment.

15. Damage to Premises or Lack of Access Due to Construction. If the Premises is damaged or destroyed by any cause not the fault of Tenant, Landlord shall have the right, at Landlord's sole cost and expense to repair it, and the rent payable under this Lease shall be abated for the time and to the extent Tenant is prevented from occupying the Premises in its entirety. Notwithstanding the foregoing, if the Premises is damaged or destroyed and Landlord elects not to repair it or repair of the damage or destruction cannot be completed within 90 days: (i) Landlord may, in lieu of making the repairs required by this paragraph, terminate this Lease by giving Tenant thirty (30) days' written notice of termination; or (ii) Tenant may terminate this Lease by giving Landlord thirty (30) days' written notice of termination. Tenant recognizes that during summer recess periods (approximately June to August) the Landlord may need to complete facility repairs and infrastructure replacement that may render the premises unfit for occupation for the duration of the construction. As of the date of this Contract, no Construction or Renovation projects are in the foreseeable future at this location. For any period of time for which the Tenant has a lack of access due to construction, the Landlord shall abate the rent. Landlord will provide the Tenant as much notice as possible of anticipated construction.

16. Hazardous Materials. Tenant shall not use, store, generate, release or dispose of any hazardous material on the Premises or the property of which the Premises are a part.

17. Tenant's Obligations Upon Vacating Premises. Upon termination of this Lease, in addition to any obligations imposed by Section 8, Tenant shall: (i) give Landlord copies of all keys or opening devices to the Premises, including any common areas; (ii) vacate the Premises and surrender it to Landlord empty of all persons and personal property; (iii) vacate all parking and storage areas; and (iv) deliver the Premises to Landlord in the same condition as referenced in Section 7, ordinary wear and tear excepted.

18. Indemnification. Tenant shall indemnify, defend and hold Landlord and Landlord's agents, employees, board members and contractors harmless from all claims, disputes, liability, litigation, judgments, costs and expenses (including reasonable attorneys' fees) (collectively, "Losses"), arising out of or related to Tenant's use, occupation or maintenance of the Premises. Landlord shall indemnify, defend and hold Tenant harmless from all Losses arising out of the sole negligence or willful misconduct of Landlord or Landlord's employees, agents or contractors.

19. Attorneys' Fees. In any action or proceeding arising out of this Lease, the prevailing party between Landlord and Tenant shall be entitled to reasonable attorneys' fees and costs from the non-prevailing party.

20. Entire Agreement. This Lease contains the entire understanding of the parties hereto with respect to the subject matter hereof and no prior agreement or understanding pertaining to any such matter shall be effective for any purpose.

21. Amendment. This Lease may be terminated, extended or amended in writing by the mutual consent of the parties hereto. Such modification may be executed by the Executive Director of the Tenant and by the Superintendent or designee of the Landlord.

22. Partial Invalidity. If any term, covenant, condition or provision of this Lease is found by a court of competent jurisdiction to be invalid, void or unenforceable, the remainder of the provisions hereof shall remain in full force and effect and shall in no way be affected, impaired or invalidated thereby.

23. Interpretation; Headings. Section headings in this Lease are for convenience only and are not intended to be used in interpreting or construing the terms, covenants and conditions of this Lease. Time is of the essence in this Lease.

24. Waiver. No waiver by Landlord or Tenant of any default or breach of any term, covenant or condition hereof shall be construed as a waiver of any other term, covenant or condition or of any subsequent default or breach of the same or any other term, covenant or condition, nor shall any custom or practice that may develop between the parties be construed so as to waive or lessen the right of Landlord or Tenant to insist upon the performance by the other of any term, covenant or condition hereof.

25. Building Hours: Normal Business Hours 7:00 A.M. to 7:00 P.M. Monday-Friday. The building shall be closed on observed holidays unless other arrangements are requested in writing by Tenant. Please see attached list of Rio School District Holidays.

26. Prior to taking possession of premises, Tenant will provide the First 5 Ventura County Safety Procedures including all COVID related protocols.

27. Notices and Payments. All notices required by this Lease shall be in writing and all notices and payments shall be made as follows:

If to Landlord:

Rio Unified School District
2500 E Vineyard Ave #100,
Oxnard, CA 93036
Attention: Wael Saleh

If to Tenant:

First 5 Ventura County
2580 E. Main Street, Suite 203
Ventura, CA 93003
Attention: Petra Puls, Executive Director

IN WITNESS WHEREOF, the parties have executed this Lease of the date first written above.

RIO UNIFIED SCHOOL DISTRICT

By: _____
Name: John Puglisi, Ph.D.
Title: Superintendent

"LANDLORD"

FIRST 5 VENTURA COUNTY

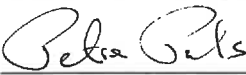
By: 
Name: Petra Puls
Title: Executive Director

"TENANT"

9.20



Agenda Item Details

Meeting	Jun 29, 2022 - RSD Regular Board Meeting
Category	9. Consent
Subject	9.20 Approval of the Non Public School – Passageway School Contract
Access	Public
Type	Action (Consent)
Fiscal Impact	Yes
Dollar Amount	77,356.60
Budgeted	Yes
Budget Source	Special Education Funds
Recommended Action	Staff recommends board approval of Passageway School contract.

Public Content

Speaker: Nadia Villapudua, Director of Pupil Personnel Services

Rationale:

In order to meet the very significant social/emotional/and behavioral needs of the student and implement the student's Individualized Education Program (IEP), the student requires placement in a Non-Public School in Newbury Park, CA.

The estimated cost from September 6, 2022 until June 16, 2023 is: \$77,356.60.

Administrative Content

Executive Content

Our adopted rules of Parliamentary Procedure, Robert's Rules, provide for a consent agenda listing several items for approval of the Board by a single motion. Most of the items listed under the consent agenda have gone through Board subcommittee review and recommendation. Documentation concerning these items has been provided to all Board members and the public in advance to assure an extensive and thorough review. Items may be removed from the consent agenda at the request of any board member.

9.21

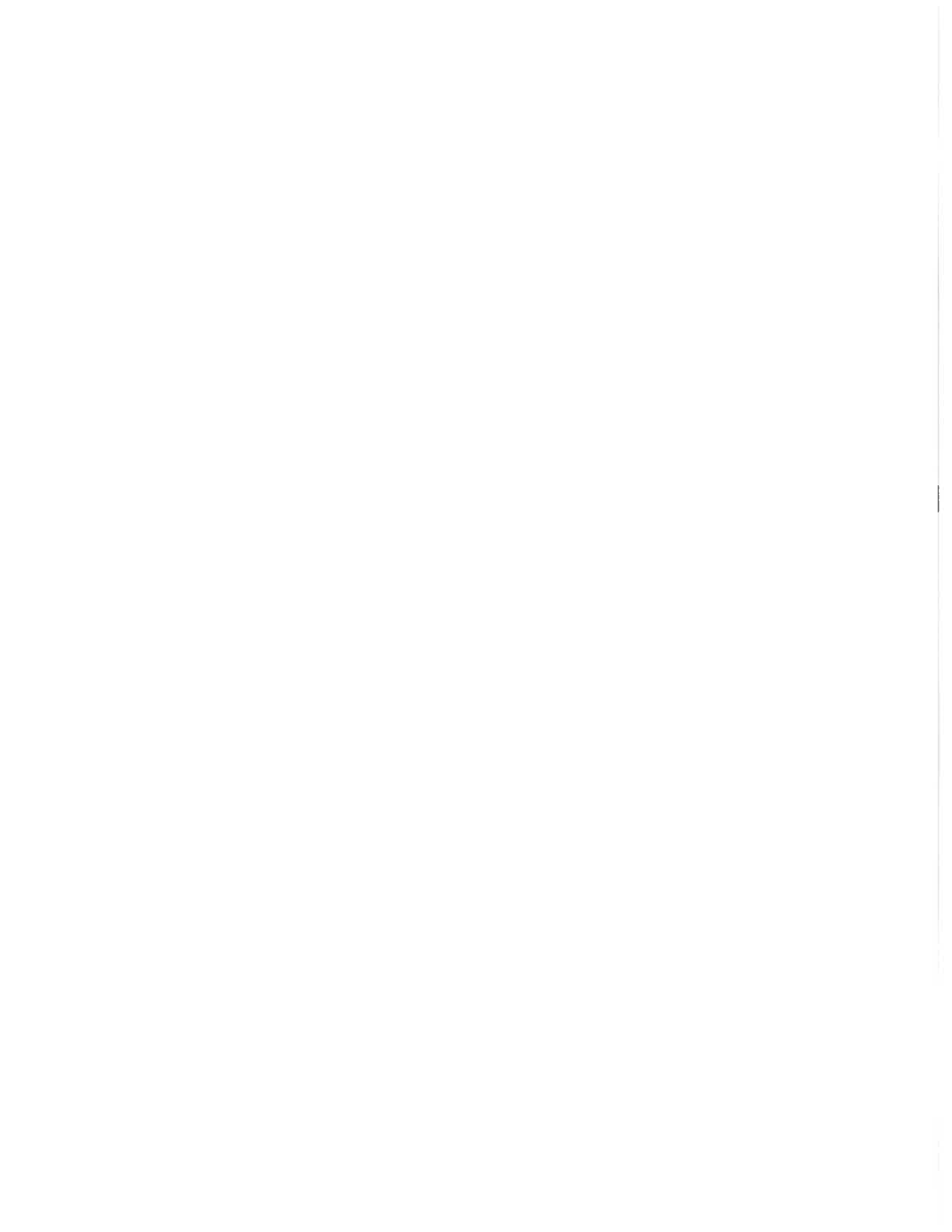



Agenda Item Details

Meeting	Jun 29, 2022 - RSD Regular Board Meeting
Category	9. Consent
Subject	9.21 Approval of the Contract with 360 Degrees Customer Inc. for Speech and Language Services
Access	Public
Type	Action (Consent)
Fiscal Impact	Yes
Dollar Amount	836,895.60
Budgeted	Yes
Budget Source	Special Education Funds
Recommended Action	Staff recommends board approval of the Contract with 360 Degrees Customer Inc. to Provide Speech and Language Service.

Public Content

Speaker: Nadia Villapudua, Director of Pupil Personnel Services

Rationale:

Due to a shortage in qualified Speech and Language Pathologist applying directly to the district for positions and in order to meet the needs determined by students' Individualized Education Plans (IEPs), the Pupil Personnel Services Department has found it necessary to contract with 360 Degree Customer Inc. for 5.5 FTE Speech and Language Pathologist for the 2022-2023 school year.

The contracted Speech Pathologists will be held to the same standard as district employees and will be provided training to ensure that they are able to conduct appropriate assessments, write legally compliant reports, write and hold effective IEPs, and meet the needs of their student's IEPs. The contracted Speech Pathologist will attend regular district meetings and trainings in order to build rapport within the department and strengthen district special education programs.

[Contract_360_Rio_CA_2022-23 \(2\) \(1\).pdf \(405 KB\)](#)

Administrative Content

Executive Content

Our adopted rules of Parliamentary Procedure, Robert's Rules, provide for a consent agenda listing several items for approval of the Board by a single motion. Most of the items listed under the consent agenda have gone through Board subcommittee review and recommendation. Documentation concerning these items has been provided to all Board members and the public in advance to assure an extensive and thorough review. Items may be removed from the consent agenda at the request of any board member.

PROFESSIONAL SERVICES AGREEMENT

By this agreement made and entered into on the May 20th, 2022, between the Rio School District (hereinafter referred to as RSD) located at 1800 Solar Drive, CA 93030 and 360 Degree Customer Inc (hereinafter referred to as Consultant) located at 473 Sapena Court # 7 Santa Clara, CA 95054, in consideration of their mutual covenants, the parties hereto agree as follows:

A. DUTIES OF CONSULTANT The Consultant shall provide the following Professional services, studies and/or reports. The Speech Therapist will also need to hold IEP meetings, complete IEPs, track and monitor all services, and attend meetings and trainings

Provide direct therapy service, recommend equipment to carry out therapy program in consultation with director, principals, teacher/school staff and parents. Continuous service unless contractor gives 45 day notice or superintendent gives 45 day notice to terminate or amend.

B. CONTRACT PERIOD: The Consultant's work as specified in this agreement shall commence on Date as specified in Addendum A

C. COMPENSATION For the full performance of this agreement, the RSD shall pay the Consultant as follows:
Consultant's Fee :

- a.) For Consultant : Name of the Consultant and Rate as Specified in Addendum A
- b.) Consultants will work for 5 days (40 billable hours) per week as per school year calendar

Payment to be made as follows: Payments to be made every month within 45 days of receipt of invoice.

D. GENERAL TERMS AND CONDITIONS

2. INDEMNIFICATION:

- a.) Except with regard to professional negligence, as provided in paragraph (b) below, the
- b.) Consultant shall indemnify, hold harmless and defend the (RSD) and each of its, officers, officials, employees, volunteers and agents from any and all loss, liability, fines, penalties, forfeitures, costs and damages (whether in contract, tort or strict liability, including but not limited to personal injury, death at any time and property damage) incurred by RSD, the Consultant or any other person and from any and all claims, demands and actions in law or equity (including reasonable attorney's fees and litigation expense), arising or alleged to have arisen directly or indirectly out of the active or passive negligence of the Consultant or any of its employees or agents in the performance of this contract. The Consultant's obligations under the preceding sentence shall apply regardless of whether the RSD or any of its, officers, officials, employees, volunteers or agents are actively or passively negligent, but shall not apply to any loss, liability, fines, penalties, forfeitures, costs or damages caused solely by the active negligence or by the willful misconduct of the RSD.

- c.) Specifically regarding professional negligent errors or omissions, the Consultant shall indemnify,

hold harmless, and defend the RSD, its officers, officials, employees, volunteers or agents, from any and all loss, liability, costs and damages (whether in contract, tort or strict liability, including but not limited to personal injury, death at any time and property damage) incurred by the RSD, the Consultant or any other person, and from any and all claims, demands and actions in law or equity (including reasonable attorney's fees and litigation expenses) incurred by RSD, the Consultant, or any other person, to the proportionate extent that it arises out of or in connection with the professional negligent errors or omissions of the Consultant in the performance of this contract.

d.) If the Consultant should subcontract all or any portion of the work to be performed under this agreement, the Consultant shall require each Sub-Consultant to indemnify, hold harmless and defend the RSD, its officers, officials, employees and agents in accordance with the terms of the preceding paragraphs.

2. NON-DISCRIMINATION No discrimination shall be made in the employment of persons under this agreement because of the race, religion, sex, age, national origin, ancestry, political affiliations, disability, medical condition, marital status, or sexual orientation.
3. CONFLICT OF INTEREST Before executing this agreement, the Consultant shall disclose to the RSD the identities of any board member, officer, or employee of the RSD, or relatives thereof, who the Consultant knows or should know will have any financial interest resulting from this agreement.
4. LICENSE AND AUTHORITY: The Consultant will maintain all necessary licenses during the term of this agreement. If other than a natural person, Consultant is duly authorized to enter into this agreement by its governing or controlling body. Evidence or copies of all necessary licenses must accompany this agreement.
5. EQUIPMENT AND FACILITIES RSD and The Consultant will agree on all necessary equipment and facilities to render services pursuant to this agreement.
6. ASSIGNMENT Without the written consent of the RSD, this agreement is not assignable by the Consultant.
7. NON-SOLICITATION OF EMPLOYEES: RSD agrees to not solicit for hire employees of Contractor for a period of not less than 1 (One) Year following the last date of that employee's services to RSD. After completion of 1 full billable year, RSD may hire the said employee after paying a referral fee to contractor. This fee will be agreed between RSD and the contractor.
8. SUCCESSORS AND ASSIGNS. This agreement shall be binding on the heirs, executors, administrators, successors, and assigns of the respective parties.
9. TIME. Time is the essence of this agreement.
10. GOVERNING LAW. The validity of this agreement and any of its terms or provisions as well as the rights and duties of the parties hereunder shall be governed by the laws of the state of Washington State.
11. WITHHOLDING. The RSD shall not withhold or set aside any money on behalf of the Consultant for Federal Income Tax, State Income Tax, Social Security Tax, Unemployment Insurance, Disability Insurance, or any other federal or state fund whatsoever.
12. CHANGES OR ALTERATIONS. No changes, alterations, or variations of any kind to this agreement are authorized without the written consent of the RSD.
13. HEADINGS. All section headings contained herein are for clarification and convenience of reference only and are not intended to limit the scope of any provision of the agreement.

14. **TERMINATION.** The RSD may terminate this agreement and be relieved of the payment of any consideration to the Consultant should the Consultant fail to perform under this agreement. Either party may also terminate this agreement upon 45 days written notice to other party with or without cause. In the event of elective termination (without cause), RSD agrees to pay Consultant for work completed to date of termination.
15. **AMBIGUITY.** The language herein shall be construed as jointly proposed and jointly accepted, and in the event of any subsequent determination of ambiguity, all parties shall be treated as equally responsible for such ambiguity.
16. **COPYRIGHT.** Any written or electronic media product produced as a result of this contract shall be a work for hire and shall be the property of the RSD.

E. VENDOR IS A CONSULTANT AND NOT AN EMPLOYEE

This agreement is not a contract of employment. At all times the Consultant shall be deemed to be an independent Consultant and is not authorized to bind the RSD to any contracts or other obligations, or to state or imply that he or she is an employee or authorized representative of the RSD, or to utilize the RSD's letterhead or logo without the prior consent of the RSD. Each of the following factors, in addition to other provisions of this Agreement, confirms the Consultant's status as an independent Consultant and not an employee. Except as otherwise set forth herein or agreed to by the parties in writing, the Consultant and RSD agree to comply with each of the following factors as is necessary to maintain independent Consultant status, each of which shall form a part of this Agreement:

INSTRUCTIONS	The RSD shall provide job specifications and instructions.
TRAINING	The RSD would provide training and meetings that the consultant needs to attend
RIGHT TO HIRE OTHERS	The consultant (mentioned below in Addendum - A) would not be allowed to hire others to do their work.
WORK ESSENTIAL TO RSD	The consultant's work is essential to RSD in relation to them providing all of the services provided in section
TIME TO PURSUE OTHER WORK	The Consultant may pursue other work during our agreement but not if it interferes with the hours and days worked at RSD or any other provisions listed in part A.
JOB LOCATION	RSD controls the job location.
BASIS OF PAYMENT	Payment shall be by the time expended.
WORK FOR MULTIPLE FIRMS	The Consultant may work for multiple firms simultaneously.
MATERIALS, TOOLS & EQUIPMENTS	All Materials, Tools and equipment for the job shall be provided by RSD.
SERVICES AVAILABLE TO PUBLIC	The Consultant's services are available to the general public.
RIGHT TO TERMINATE	The Consultant may not be terminated except as allowed for under the agreement.

PROGRESS REPORTS	The consultant would have to make progress reports for the students which is a monitoring issue of the goals and services for the student.

F. UNDERSTANDING AND ACCEPTANCE OF THE PARTIES This Agreement constitutes the entire understanding of the parties. The Contract Initiator's and Consultant's signatures below signify both an understanding and acceptance of the contract provisions.

G. CONTRACT INITIATOR (RSD Representative)

CONSULTANT

Signature: _____

Signature: _____

Date Signed: _____

Date Signed: _____

Branch / Dept.: _____

Title: CEO

Address (or Mail Code): _____

Company Name & Address: 360 Degree Customer Inc
4423 Fortran Dr., Ste #114, San Jose, CA 95014

Phone / Fax: Ph: _____

Phone / Fax: Ph 408-406-7253, Fx 408-719-9900

E-Mail Address: _____

E-Mail Address: gulneesh@360customer.com

ADDENDUM – A

School year: 2022-23

Spanish Bilingual SLPs

Rate: \$ 108.15/hour

Names:

JeanLiz Perez (Full time)

Helen Rodriguez (Full time)

Jose Davilla (Full time)

Natacha Sanchez (Full time)

Monolingual SLPs:

Rate: \$ 92.70/hour

Names:

David Olson (Full time)

Malia Moore (50%)

9.22



Agenda Item Details

Meeting	Jun 29, 2022 - RSD Regular Board Meeting
Category	9. Consent
Subject	9.22 Approval of the Contract with Soliant Health for Speech and Language Services
Access	Public
Type	Action (Consent)
Fiscal Impact	Yes
Dollar Amount	127,587.60
Budgeted	Yes
Budget Source	Special Education Funds
Recommended Action	Staff recommends board approval of Soliant Health Contract

Public Content

Speaker: Nadia Villapudua, Director of Pupil Personnel Services

Rationale:

Due to a shortage in qualified Speech and Language Pathologist applying directly to the district for positions and in order to meet the needs determined by students' individualized education plans, the Pupil Personnel Services Department has found it necessary to contract with Soliant Health, LLC for the services of one full-time Speech and Language Pathologist for the 2022-2023 school year.

The contracted Speech Pathologist will be held to the same standard as district employees and will be provided training to ensure that they are able to conduct appropriate assessments, write legally compliant reports, write and hold effective IEPs, and meet the needs of their student's IEPs. The contracted Speech Pathologist will attend regular district meetings and trainings in order to build rapport within the department and strengthen district special education programs.

[Soliant Contract for Rebecca Ball 22-23.pdf \(334 KB\)](#)

Administrative Content

Executive Content

Our adopted rules of Parliamentary Procedure, Robert's Rules, provide for a consent agenda listing several items for approval of the Board by a single motion. Most of the items listed under the consent agenda have gone through Board subcommittee review and recommendation. Documentation concerning these items has been provided to all Board members and the public in advance to assure an extensive and thorough review. Items may be removed from the consent agenda at the request of any board member.

CLIENT SERVICES AGREEMENT
Education Division



Soliant Health, LLC (hereafter referred to as "Soliant"), and

Rio School District
(Client Name)

whose location is

1800 Solar Drive
(Street Address)

Oxnard, CA 93030
(City, State, Zip)

(hereafter referred to as "Client")

enter into this non-exclusive Client Services Agreement for the purpose of referring and placing its employees ("Consultants") with Client. This Agreement shall govern the overall terms of the relationship, while a separate Assignment Confirmation (Addendum A) for each placement will outline specifics as to bill rates, personnel, and assignment lengths.

1. Scope of Services.

Soliant, a licensed staffing agency in the business of providing supplemental staffing to the public and private education sector and not a healthcare provider, will use its commercially reasonable efforts to provide Consultants for assignment with Client. Soliant will be responsible for payment of each Consultant's wages and applicable payroll taxes, deductions, and insurance, including workers' compensation, general liability and professional liability coverage for the benefit of the Consultants. If a Consultant is unable to complete the specified assignment, Soliant will use its commercially reasonable efforts to find a replacement in a timely manner.

2. Independent Contractor.

The parties hereto specify and intend that the relationship of each to the other is that of an independent contractor, that each Consultant shall be an employee of Soliant and that no qualified Consultant shall at any time be an employee of Client, unless the parties shall otherwise agree in writing. Soliant agrees to provide and maintain all payroll services for any qualified Consultant placed with Client, to maintain payroll records and to withhold and remit all payroll taxes and social security payments. Soliant does not ordinarily use subcontractors in providing services. Should the need to use a separate staffing firm or independent contractor arise, Soliant will notify Client in advance of the assignment in order to receive approval of this arrangement.

3. Telepractice Services.

Soliant, at Client's specific request, may provide telepractice services through VocoVision. Should utilization of VocoVision occur, Client shall, at that time, receive in addition to Addendum A – Client Assignment Confirmation, an Addendum B – Teleservices Provisions, Addendum C – Duties and Responsibilities and Addendum D – VocoVision Equipment Policies which, collectively, outline specific terms and conditions regarding VocoVision's telepractice services.

4. Insurance.

Soliant will maintain at least the following minimum amounts of insurance:

General Liability - \$2,000,000 per occurrence and \$4,000,000 aggregate.

Workers Compensation - in accordance with state regulations.

Employers Liability - \$1,000,000.

Excess Liability over General Liability and Employer's Liability - \$5,000,000 per occurrence and \$5,000,000 aggregate.

Professional Liability of \$1,000,000 per occurrence and \$3,000,000 aggregate.

5. Competency and Licensing.

Soliant will conduct comprehensive pre-employment screening to provide licensed Consultants who meet applicable professional standards. Soliant will endeavor to present only Consultants who are qualified for Client's open position(s) on job requirements established by Client either verbally or in writing. While Soliant will make every effort to pre-screen job candidates based on these requirements, Client acknowledges the candidate assignment decision is ultimately the responsibility of the Client. To this end, Soliant will make available to Client all appropriate Consultant records that Soliant may permissibly disclose and will facilitate an interview between Client and Consultant in order to assist Client in the hiring decision. Soliant will do its due diligence to ascertain the professional and applicable Department of Education licensing and certification requirements for the Consultant discipline placed with Client, however, it is ultimately the responsibility of the Client to approve the Consultant's licensure and certifications as acceptable.

6. On-Site Responsibility.

Client is responsible for providing all orientation, support, facilities, training, direction, and means for the Consultant to complete the assignment. Client acknowledges that Soliant is not providing nursing or healthcare services, but rather is providing candidate identification and placement services. As such, Client is responsible for the Consultant's adherence to the applicable standard of practice and acknowledges that Soliant is not responsible for the Consultant's on-site performance given that Soliant does not have the capacity to provide direct, on-site supervision of daily activity. Client

CLIENT SERVICES AGREEMENT
Education Division



acknowledges that any deviation of the Client's policies and procedures as orientated to Soliant's Consultant should be reported in writing and directly to Soliant immediately so that Soliant may be provided an opportunity to offer correction and/or counseling of unacceptable practices by Consultant. Client warrants that its facilities and operations will comply at all times with all federal, state and local safety and health laws, regulations and standards, including OSHA standards, and that Client will be responsible for providing all safety training and equipment, and for each Consultant's compliance with health and safety requirements, including those instituted by Client.

7. Employment of Consultants.

Client agrees that it will not directly or indirectly, personally or through an agent or agency, contract with or employ any Consultant introduced or referred by Soliant for a period of one year after the latest date of introduction, referral, placement, or end of the contract assignment. If Client or its affiliate enters into such a relationship or refers Consultant to a third party for employment, Client agrees to pay an amount equal to \$21,500 or thirty-five (35) percent (whichever is greater) of the Consultant's first year's annual salary, including any signing bonus, as agreed upon at the time of hiring. Payment is due and payable to Soliant upon start date.

8. Equal Opportunity.

It is the policy of Soliant to provide equal opportunity to all Consultants for employment. Soliant and Client will screen based on merit only. All Consultants will be free from discrimination due to race, religion, color, sex, national origin, age, or disability.

9. Payment Terms.

Client will be billed on a weekly basis for work performed during the previous week and pay Soliant based on the service charges specified in the Assignment Confirmation included as an addendum to this Agreement. Based on current federal, state and/or local legislation, all time worked in excess of eight (8) hours per day will be billed at one and one-half times the regular bill rate. It is Client's responsibility to notify Soliant if pre-approval is required for any or all overtime hours prior to any such hours being worked. Payment is due within fifteen (15) days of receipt of invoice.

10. Default Charges.

Invoices shall be considered past due if not paid by the agreed-upon due date. Client agrees to pay all necessary collection costs of amounts past due, including reasonable attorney's fees and costs. Additionally, Soliant reserves the right to approve or to discontinue any extension of credit and the terms governing such credit.

11. Limitation of Liability.

NEITHER PARTY SHALL BE LIABLE TO THE OTHER WHATSOEVER FOR ANY SPECIAL, CONSEQUENTIAL, INDIRECT, EXEMPLARY OR PUNITIVE DAMAGES, INCLUDING ANY DAMAGES ON ACCOUNT OF LOST PROFITS, LOST DATA, LOSS OF USE OF DATA, OR LOST OPPORTUNITY, WHETHER OR NOT PLACED ON NOTICE OF ANY SUCH ALLEGED DAMAGES AND REGARDLESS OF THE FORM OF ACTION IN WHICH SUCH DAMAGES MAY BE SOUGHT. THE FEES AND BILLINGS DUE UNDER THIS AGREEMENT ARE NOT CONSIDERED SPECIAL DAMAGES OR LOST PROFITS AND SHALL NOT BE LIMITED BY THESE PROVISIONS.

12. Administrative Responsibilities.

Client shall be responsible for orienting Consultant to Client's policies and procedures regarding the submission of any requisite paperwork which must be tendered for reimbursement by funding entities such as Medicare, Medicaid, or health insurance. Such paperwork may include, but is not limited to, patient care plans, comprehensive patient histories, individual education plans, or Client specific program plans. During the contracted assignment, should Consultant fail to submit paperwork as required per Client's policies and procedures, Client must notify Soliant in writing within three (3) business days of alleged failure. Failure to notify Soliant before assignment ends shall negate any Client claim to withhold payment due to untimely work and/or paperwork non-compliance by Consultant. Client agrees that all approved time sheets by Client's assigned representative are not subjected to billing dispute if Client fails to notify Soliant of time sheet and work performed discrepancies.

13. Incident and Error Tracking.

Client will report to Soliant any performance issues, incidents, errors and other events related to the care and services provided by Soliant employees. Soliant will document reported incidents in employee's personnel file and track all such events for quality assurance purposes. All supporting documentation is required within seventy-two (72) hours of the occurrence.

14. Reporting of Work-Related Injuries.

Client will maintain a safe working environment and provide all appropriate personal protective equipment as deemed appropriate for unit to which Soliant's Consultant has been assigned. Client ensures compliance with all applicable OSHA or state Department of Labor obligations to include general training on the reporting of work-place injuries, incidents, and occupational exposure to bloodborne pathogens occurring at Client facility. Records of such occurrences must be maintained by the Client and accessible to Soliant within guidelines set forth by governing entities. In the event of work-

CLIENT SERVICES AGREEMENT Education Division



place injury, incident or exposure, each affected Consultant will contact their immediate Client-appointed supervisor and report to the applicable treating department as per Client protocol. Consultant shall also report work-place injury, incident or exposure to Soliant concurrently with Client for the purpose of reporting such event to Soliant's workers compensation carrier. If Client's reporting requirements change during the term of this Agreement, Client is responsible for written notification of such information to both Soliant and Soliant's Consultant.

15. Termination of Contracted Assignment with Cause.

Immediately upon occurrence, Client has the obligation to report each deviation from the accepted standard of practice, policies and procedures as orientated to Consultant, behavior, and or any incident that would be considered adverse to the overall operation of Client. Client may request that Soliant facilitate the immediate removal of Consultant due to any of the issues preceding with written and/or verbal notice. The Client, however, may not immediately terminate a Consultant unless Soliant has been notified prior to final incident or unless a single incident warrants immediate dismissal prior to Soliant's notification. All supporting documentation specifying the reasons and facts of the termination is required within forty-eight (48) hours of termination. If the Client does not report such deviation(s) and subsequently terminates Consultant or if Client does not provide required documentation following a termination within the required timeframe, Client will be assessed as liquidated damages and not as a penalty, an amount equal to one (1) week of billing. The parties agree that Soliant's Consultant s are an integral part of its operation and a resource that may have been developed over a number of years. Any delay or absence of a written and verbal notice could result in lost revenue or other consequences not foreseen at this time and therefore the liquidated damages are not unreasonable to the probable loss to be suffered by Soliant in the event of your breach of this provision. Client will be responsible for all professional fees (and expenses if applicable) up to the point of termination. Termination with cause must be documented prior to termination in accordance with the Incident and Error Tracking procedures set forth in paragraph 13 of this agreement. Soliant shall have five (5) business days to refill the position in the event of termination with cause. Should Soliant identify a suitable Consultant, Client agrees to original terms or extended terms of the terminated Consultant s assignment.

16. Termination of Contracted Assignment without Cause.

Client may cancel an assignment with thirty (30) days written notice. Client is responsible for all charges and fees prior to cancellation date and through the 30-day period of notice. In the event Client is unable to provide thirty (30) days' notice of termination, Client will be billed for thirty (30) days at the agreed upon regular bill rate and minimum hours. In the event of termination without cause, Client will be responsible for any housing and travel costs actually incurred by Soliant as a result of such cancellation.

17. Guaranteed Minimum Hours.

Client agrees to provide Consultant the guaranteed number of work hours per week specified in the attached Assignment Confirmation Addendum A. Cancellation of prescheduled workdays or reduction in work hours by Client will be billed reflecting the guaranteed minimum work hours. Minimum work hours shall be reduced to reflect scheduled school closings for holidays and planning days.

18. Paid Sick Leave.

For those jurisdictions that have passed or will pass legislation requiring Paid Sick Leave, Paid Sick Time will be billed back to Client at the straight-time bill rate for all hours taken by any Consultant assigned to Client. This section is not applicable until the effective date of such legislation has been reached.

19. Unscheduled Facility Closure Policy.

Soliant will incur fixed expenses over the entire course of a Consultant's contract assignment with Client related to the Consultant's housing and per diem costs. The parties agree that in the event of an unforeseen or unexpected interruption in a Consultant's assignment resulting from an unscheduled closure, complete or partial, of Client's facilities due to natural or manmade disasters, such as, and without limiting the generality of the foregoing, fire, storms, flooding, earthquake, labor unrest, riots, and/or acts of terrorism or war (each an "Unscheduled Closure"), Client will transition to virtual services for all Consultants whose services can be performed in such a setting. Client shall be billed for services performed at the regular contracted hourly bill rate for all hours worked by Consultant. Virtual service hours shall be entered and processed according to the normal time submittal and approval process unless otherwise requested by Client and agreed upon by Soliant. Soliant and Client will mutually determine which contracted disciplines qualify for virtual services. For contracted services not eligible for virtual services, Client will be invoiced and shall pay for each such affected Consultant's services at the reduced rate of \$200 per day for each day that the Consultant(s) is unable to work by virtue of such Unscheduled Closure.

20. Multiple Locations.

If client requires Consultant to travel to and perform services at more than one location, Client will compensate Soliant for travel time between facilities at the regular hourly bill rate and for mileage up to the current acceptable IRS reimbursement rate.

CLIENT SERVICES AGREEMENT
Education Division



21. Issue Resolution.

In the event Client encounters an issue that is not satisfactorily resolved by its Soliant representative, Client should escalate the issue to the appropriate Soliant manager by calling 800-849-5502. Please ask for your account representative's manager.

22. Indemnification.

To the extent permitted by law, each party will indemnify, defend and hold harmless the other against third party claims arising from breaches of the parties' respective obligations under this Agreement.

23. Confidentiality.

Each party acknowledges that as a result of this Agreement, they will learn confidential information of the other party. Confidential information is defined as that information which is private to each party but is shared by one to the other party as required to accomplish this Agreement and **includes bill rates, fees for permanent placements and terms and conditions of this Agreement.** It is agreed that neither party will disclose any confidential information of the other party to any person or entity. Neither will it permit any person nor entity to use said confidential information. The only exceptions will be: (a) Information shared to the appropriate individuals within the respective organizations as necessary to execute this Agreement, (b) disclosures as required by law. Confidential information of Soliant shall include, but is not limited to, any and all unpublished information owned or controlled by Soliant and/or its employees, that relates to the clinical, technical, marketing, business or financial operations of Soliant and which is not generally disclosed to the public including but not limited to employee information, technical data, policies, financial data and information to include contract terms and provisions, billing rates, permanent placement fees whether disclosed orally, in writing or by inspection. If the receiving party shall attempt to use or dispose of any of the Confidential Information, or any duplication or modification thereof, in any manner contrary to the terms of the foregoing, the disclosing party shall have the right, in addition to such other remedies which may be available to it, to obtain an injunctive relief enjoining such acts or attempts as a court of competent jurisdiction may grant, it being acknowledged that legal remedies are inadequate.

Except for the purposes of implementation and/or enforcement, Soliant and Client agree that this agreement shall be confidential to the extent allowable by law.

24. Family Education Rights and Privacy Act.

Soliant shall comply with all laws, rules and regulations pursuant to the Family Educational Rights and Privacy Act, 20 USC 1232g ("FERPA") and acknowledges that certain information about the Client's students is contained in records maintained by Soliant and the Consultant and that this information can be confidential by reason of FERPA and related Client policies. Both parties agree to protect these records in accordance with FERPA and Client policy. To the extent permitted by law, nothing contained herein shall be construed as precluding either party from releasing such information to the other so that each can perform its respective responsibilities. As it applies, Consultant's assigned to Client will execute a FERPA Statement of Understanding outlining appropriate guidelines.

25. State Retirement System Notice.

This notice is intended to clarify the manner of payment in contemplation of a Consultant's mandatory or permissive participation in a state teacher retirement system, school employees' retirement system, and/or any similar or successor system applicable to the professionals provided by Soliant. Client acknowledges and agrees that if formal notice is required to be given to any Consultant that participation in any such retirement system/pension is either: 1) permitted by Consultant's election; or 2) is required by law, then Client is solely responsible for providing such notice to Consultant and fulfilling all associated administrative duties. Client shall immediately notify Soliant if any Consultant is required to, or voluntarily elects to participate in any such system. In such event, Client shall advise Soliant of the withholding obligation percentages (both employer and employee share) so that invoices to Client and payment to the Consultant may be adjusted accordingly. The parties agree that Client shall withhold and pay to the retirement/pension both the employee and employer shares. The parties agree that the applicable employee and employer shares paid to the system by the Client shall be deducted from the amount owed to Soliant by the Client hereunder. The parties agree that the applicable employee share paid to the system by the Client shall be deducted from the amount due the Consultant by Soliant. The Client and Soliant expressly acknowledge and agree that if any Consultant is required to, or elects to participate in a retirement system/pension, the Client shall be solely responsible for: 1) creating an account for Consultant with the appropriate retirement system/pension; 2) all present and/or future obligations to make employee and employer cash payments/ contributions to the retirement system/pension as required by law and/or set by the retirement system/pension; and 3) otherwise administering all employer functions pertaining to the Consultant's interest in retirement system/pension.

26. Conflicts of Interest.

The parties acknowledge their respective obligation to report any conflict of interest and/or apparent conflict of interest that may interfere with their ability to perform their obligations hereunder objectively and effectively. To that end, the Parties hereby certify and represent that their officials, employees and agents do not have any significant financial or other pecuniary interest in the other party's business enterprise, and that no inducements of monetary or other value were

CLIENT SERVICES AGREEMENT
Education Division



offered or given to any officer, employee or agent of the other party. Each party agrees to promptly notify the other in the event it becomes aware of any conflict of interest or apparent conflict of interest.

27. Survival.

The parties' obligations under this Agreement which by their nature continue beyond termination, cancellation or expiration of this Agreement, shall survive termination, cancellation or expiration of this Agreement.

28. Governing Law.

This Agreement shall be governed by the laws of the state of Delaware.

29. Modification of Agreement.

This Agreement may not be modified, amended, suspended, or waived, except by the mutual written agreement of the Parties who are authorized to execute the agreement.

30. Entire Agreement.

This Agreement represents the entire agreement between the parties and supersedes any prior understandings or agreements whether written or oral between the parties respecting the subject matter herein. This Agreement may only be amended in a writing specifically referencing this provision and executed by both parties. This Agreement shall inure to the benefit of and shall be binding upon the parties hereto and their respective heirs, personal representatives, successors and assigns, subject to the limitations contained herein. The unenforceability, invalidity or illegality of any provision of this Agreement shall not render any other provision unenforceable, invalid or illegal and shall be subject to reformation to the extent possible to best express the original intent of the parties. This Agreement and attached Assignment Confirmation contain terms that may only be altered when agreed upon in writing by both parties.

This Agreement and attached Assignment Confirmation contain terms that may only be altered when agreed upon in writing by both parties. *(Please return all pages of this Client Services Agreement)*

RIO SCHOOL DISTRICT

SOLIANT HEALTH, LLC

Client Representative Signature

Date

Soliant Representative Signature

Date

Print Name

Print Name

Title

Title

hdi

Israel Childs

managing Director

CLIENT REQUIRED DOCUMENTS CHECKLIST



Client: Rio School District

City, State: Oxnard, CA

In an effort to provide all necessary documentation for travel healthcare professionals assigned to your facility, we ask that you complete this form to be used as a reference for all personnel placed in your facility.

Standard Credentialing Package

As part of our Standard Credentialing Package, Soliant will provide the following prior to the start of a contracted assignment.

PROFESSIONAL:

- Current CV / Resume
- Current Skills Checklist, if applicable
- References

LICENSURE

- Professional License, as applicable
- Professional Certification, as applicable
- License and/or Certification Verification

EDUCATION:

- CDC Guidelines for School Professionals
- FERPA Guidelines

BACKGROUND:

- Criminal Background Check
- GSA Exclusion Search
- HHS/OIG Search
- Sexual Offender Search

MEDICAL:

- Hepatitis B Vaccination / Declination form
- MMR Declination
- Physical Examination Waiver
- 10-Panel Drug Screen

Optional Credentialing

If your district requires any additional credentialing items above what is contained in the Standard Credentialing Package, please indicate below. If no additional items are noted, the Standard Credentialing Package will be provided.

Credentialing Documents will be held on file at Soliant and unless specifically requested, will not be forwarded to Client.

Orientation Details

- Will the contracted professional be permitted to attend Orientation while license is in process? YES NO
- Will the contracted professional be permitted to start their assignment while license is in process? YES NO

CLIENT INFORMATION REQUEST



CLIENT

School, District or Business Name: _____
Billing Address: _____
City, State, Zip: _____
Contact Name to Receive Invoice: _____
Invoice Email: _____
Invoice Email CC, if applicable: _____
Contact Phone: _____

In an effort to increase efficiency for our Clients, Soliant Health will email service invoices. Should you wish to opt out of this process, please check here

Invoice Follow-up Contact: Name: _____
 same as above Email: _____
Phone: _____

Payment Inquiry Contact: Name: _____
 same as above Email: _____
Phone: _____

SOLIANT HEALTH, LLC

Correspondence Address
Correspondence, Contracts, Contract Addendums, Notices, etc.
5550 Peachtree Parkway, Suite 500
Peachtree Corners, GA 30092
Fax Number: 877-831-8511

Remittance Address
Only payments should be sent to this address
PO Box 934411
Atlanta, GA 31193-4411

Account Representative
Name: Monica Guu
Email: monica.guu@soliant.com
Telephone: 770-723-3774

Billing Disputes, Purchase Orders, W-9 Requests
Email: billing@soliant.com
Fax: 877-831-8511



Soliant*

CLIENT ASSIGNMENT CONFIRMATION

This Client Assignment Confirmation is entered into on the date first signed below and supplements the Client Services Agreement between Soliant Health, LLC and the Client named below. The Soliant Consultant has been placed with Client and Client will pay Soliant Health for hours worked by Consultant according to the terms outlined in this confirmation.

ASSIGNMENT DETAILS

CLIENT NAME: Rio School District

Consultant: Rebecca Ball Position: SLP

Assignment Start Date: 8/18/2022 Assignment End Date: 6/16/2023

Bill Rate per hour: \$ 87.15 Overtime Bill Rate per hour: \$ 130.73

Minimum Hours: 40

Miscellaneous:

Teaching Certification: Teaching certification

DESIGNATED APPROVERS

District Personnel designated by Client to approve Timesheets. *If not applicable, respond with N/A.*

Name	Title	Phone	Email Address

Please note: Sales tax will be added to professional fees if required by state law and client is not a tax-exempt entity.

If Soliant Consultant should be required to travel to other locations at the specific request of the Client, the Client will be responsible for all expenses incurred.

Client agrees that it will not directly or indirectly, personally or through another agent or agency, contract with or employ Consultant for a period of one year after the latest date of introduction, referral, or completion of the assignment.

All hours are guaranteed if Consultant is quarantined at home due to contracting the COVID - 19 virus while on school site.

Option of virtual services will be offered by Soliant in lieu of onsite services.

All precautions will be taken by the Client to create a safe and healthy environment.

Client Signature

Client Printed Name

Client Title

DocuSigned by:

Monica Guu
Soliant Health, LLC Signature

6/9/2022

Monica Guu
Soliant Health, LLC Printed Name

Senior Account Executive
Soliant Health, LLC Title

***Terms and conditions outlined in this Client Assignment Confirmation will be considered agreed upon by all parties unless Soliant is notified of changes by Client within forty-eight (48) hours of client's receipt of this Client Assignment Confirmation.**

9.23



Agenda Item Details

Meeting	Jun 29, 2022 - RSD Regular Board Meeting
Category	9. Consent
Subject	9.23 Maxim Health Care Staffing Services Contract
Access	Public
Type	Action (Consent)
Fiscal Impact	Yes
Dollar Amount	280,800.00
Budgeted	Yes
Budget Source	LCFF one-time funds
Recommended Action	Staff recommends approval.

Public Content

Speaker: Nadia Villapudua, Director of Pupil Personnel Services

Rationale:

Licensed Vocational Nurses (LVNs) are needed to assist and support with the implementation of COVID-19 site safety measures, procedures and protocols and support the health needs of students during school hours and afterschool programs.

Contracted LVNs are held to the same standard as district employees and will be provided training to ensure that they are able to deliver appropriate health related services in accordance to our district protocols. Contracted LVNs will attend regular district trainings in order to build rapport within the Rio School District

[Maxim Contract for LVNs 6-29-22.pdf \(819 KB\)](#)

Administrative Content

Executive Content

Our adopted rules of Parliamentary Procedure, Robert's Rules, provide for a consent agenda listing several items for approval of the Board by a single motion. Most of the items listed under the consent agenda have gone through Board

subcommittee review and recommendation. Documentation concerning these items has been provided to all Board members and the public in advance to assure an extensive and thorough review. Items may be removed from the consent agenda at the request of any board member.

EDUCATION SERVICES STAFFING AGREEMENT

This Education Services Staffing Agreement (hereinafter "Agreement") is entered into this 1st of July, 2022, by and between Rio School District located at 1800 Solar Drive Oxnard, CA 93030, referred to in this Agreement as "Customer," and Maxim Healthcare Staffing Services, Inc., a Maryland Corporation including its affiliates and subsidiaries, with an office located at 735 Tank Farm Road Ste 140 San Luis Obispo, CA 93401 referred to in this Agreement as "Maxim."

RECITALS

WHEREAS, Customer operates a School, as defined by State Law located in CA and wishes to engage Maxim to provide personnel to supplement Customer's staff.

WHEREAS, Maxim operates a staffing agency that provides supplemental healthcare staffing services to Customer.

THEREFORE, in consideration of the above premises set forth herein, and for other good and valuable consideration, the receipt and sufficiency of which are acknowledged by the Parties, and intending to be legally bound, Customer and Maxim hereby agree to the following terms and conditions.

ARTICLE I. DEFINITIONS

"Agreement" means this Education Services Staffing Agreement entered into as of the Effective Date between Maxim and Customer, including all Attachment(s) attached hereto, and all Statement(s) of Work entered into by Maxim and Customer pursuant to Section 3.1.

"Assignment Confirmation" means the details as agreed upon between Customer and Maxim for Assignment Personnel Providing Assignment Services.

"Assignment Personnel" means collectively Local Assignment Personnel and Travel Assignment Personnel providing Assignment Services.

"Assignment Personnel Rate" means a rate agreed upon between Customer and Maxim for that specific Assignment Personnel, as specified in "Attachment C" and controls where different from Base Rates set forth in "Attachment A."

"Assignment Services" means Services for a specific term and length of the time, as more specifically set forth in Section 8.1 herein and "Attachment C."

"Base Rate" means the rates billed for Services performed by Personnel pursuant to terms of Agreement and "Attachment A" hereto.

"Behavior Intervention Plan" or "BIP" is defined as a written improvement plan created for a student based on the outcome of the functional behavior assessment (FBA).

"Contractor" means either independent contractor(s) or legal entity(ies) being utilized by Maxim to provide Services, as specified in Section 7.2.

“Effective Date” means the date first written above in the introductory paragraph of Agreement.

“Float” means Personnel reassigned to a different Customer department, unit, School Work Site, or to a different staff classification.

“Individual Education Program” or “IEP” is a plan developed as required under the Individuals with Disabilities Education Act (“IDEA”) providing eligible students with special education and related services that is reasonably calculated to enable the student to make progress appropriate in light of the child’s unique circumstances.

“Individual Health Plan” or “IHP” is defined as a health plan focusing specifically on student(s)’ medical needs, it may contain physician orders. If the services for a student’s medical needs can be performed during the school day for the student to benefit from the education, the medical services may be incorporated into the 504 Plan or IEP.

“Medical Services” services provided by a licensed physician to determine a student’s medically related disability that results in the student’s need for a 504 Plan or an IEP. These services include determining the health or related services needed for a particular student, developing the plan, changes to the plan, and level of healthcare or professional required.

“Personnel” means licensed and/or unlicensed clinical and other non-clinical healthcare, behavioral, educational assistance, and instructional employees of Maxim.

“Placement” is defined to mean where the student with a disability receives the services listed in the 504 Plan or the IEP.

“Related Services” means transportation and such developmental, corrective, and other supportive services as are required to assist a child with a disability to benefit from special education, and includes speech-language pathology and audiology services, interpreting services, psychological services, physical and occupational therapy, recreation, including therapeutic recreation, early identification and assessment of disabilities in children, counseling services, including rehabilitation counseling, orientation and mobility services, and medical services for diagnostic or evaluation purposes. Related services include school health services and school nurse services, social work services in schools, and parent counseling and training.

“School Health Services” means health services that are designed to enable a child with a disability to receive FAPE as described in the child’s IEP. School health services are services that may be provided by either a qualified school nurse or other qualified person as requested by the Customer.

“School Work Site” means any location Customer assigns Personnel to render Services.

“Services” means collectively School Health Services, Special Education Services, and/or Related Services provided by Maxim to Customer, as more specifically set forth in Article III and any Attachment(s) and/or Statement(s) of Work.

“Special Education Services” means specially designed instruction to meet the unique needs of a child with a disability.

“Statement of Work” or “SOW” means a statement of work describing the Services entered into by Maxim and Customer in accordance with Article III and “Attachment A” attached hereto.

“Supplies” means any and all necessary medical supplies to be used in administering and/or providing Services to student(s), including, but not limited to personal protective equipment (“PPE”).

“Term” has the meaning given is Section 2.1.

ARTICLE II. TERM

Section 2.1. Term. This Agreement will commence on the Effective Date and will continue for a school calendar year, which runs from 8/18/2022 to 6/16/2023.

Section 2.2 Renewal. This Agreement shall automatically renew at the end of the term for successive one (1) year terms unless either Party provides written notice at least thirty (30) days prior to the end of the term or renewal term, as applicable, of such Party’s decision not to automatically renew this Agreement

ARTICLE III. NATURE AND SCOPE OF SERVICES

Section 3.1 Scope of Services.

(a) Staffing. Maxim is responsible for recruiting, screening, and hiring its Personnel as set forth herein to provide temporary staffing Services to Customer, with such Services provided by Personnel under Customer’s management and supervision at a School Work Site or in an environment controlled by Customer. Maxim will use its best efforts to provide Personnel who shall perform Services in accordance with the terms of this Agreement, as requested in “Attachment A.” Services include School Health Services, Related Services, and/or Special Education Services. Maxim will provide Personnel specific to the requirements provided by the Customer, following receipt of the BIP, IEP, IHP or 504 Plan (the “Plan”), as applicable, from the Customer. Maxim will use its best efforts to provide Personnel who meet the qualifications as specified by the Customer and shall perform services in accordance with the terms of this Agreement. Customer shall provide Maxim with the skill level, experience and services to be provided by Personnel to any student(s), and details from the applicable Plan for School Health Services or Related Services, necessary to perform Services hereunder.

(b) Distance Learning Service(s). Customer may request Personnel to provide services off-site, including, but not limited to remote services and/or in-home services at a student’s location (“Distance Learning Service(s)”) due to Customer school closings and/or delays. Customer is responsible for overseeing and directing placement outside of school for Distance Learning Service if requested. Customer will provide supplies and resources needed to implement Distance Learning Services and its own expense. Customer is responsible for maintaining a safe environment for all Distance Learning Services.

(c) Changes. From time to time, requests for additions, deletions, or revisions to the Services or Base Rates may be made (collectively, the “Changes”). The Party that wishes to make a Change shall deliver to the other Party a modified Statement of Work (“SOW”) or subsequent

“Attachment A” to reflect the changes to this Agreement expressly agreed to by the parties. The Changes will take effect upon signature by both parties.

Section 3.2 School Health Services Requirements. Maxim will perform the screening for School Health Services Personnel who meet the criteria as indicated in Attachment “B” hereto.

Section 3.3 Related Services. Maxim will perform the screening for Related Services and Special Education Personnel who meet the criteria as indicated in Attachment “B” hereto.

Section 3.4 Special Education Services. Maxim will perform the screening Special Education Services Personnel who meet the criteria as indicated in Attachment “B” hereto.

Section 3.5 Maxim as Employer. Maxim acknowledges and agrees that its Personnel are employees and shall be treated as such and not as employees of Customer. Maxim agrees that it (i) is responsible for providing any wages or other benefits to its Personnel; (ii) will make all appropriate tax, social security, Medicare, and other withholding deductions and payments with respect to its Personnel; (iii) will provide workers’ compensation insurance coverage for its Personnel; (iv) will make all appropriate unemployment tax payments with respect to its Personnel; and (v) will take any additional actions legally required to establish that the Personnel whose Services are provided under this Agreement are employees of Maxim.

Section 3.6 Availability of Personnel. The Parties agree that Maxim’s duty to supply Personnel is subject to the availability of qualified Personnel. The failure of Maxim to provide Personnel shall not constitute a breach of this Agreement if the requested Personnel are not available. To the extent that Maxim is unable to provide the modality of Personnel requested by Customer, Maxim will provide Customer with a higher skilled Personnel. Maxim will bill Customer at that Personnel’s fair market value rate for the modality provided.

ARTICLE IV. SCHOOL WORK SITE REQUIREMENTS AND OBLIGATIONS

Section 4.1 Plan Implementation. Customer is responsible for the Medical Services provided to its students. Customer will provide supervision of Personnel for Services provided to any student with a medical disability. Customer will make available to Maxim and any Personnel the applicable Plan(s), as requested. Customer shall provide student specific orientation for the requirements of the Plan(s). If the student requires school transportation, Customer shall assess whether the student’s disability would allow for safe transport by Customer. Customer shall orient Maxim Personnel on the transportation and emergency protocol. Customer will make all determinations on Placement.

Section 4.2 Orientation and Evaluation. Customer will provide Personnel with orientation of Customer’s policies, procedures and School Work Site specific training. Customer will provide School Work Site specific emergency protocol training for all student’s with a medically related disability. Customer will perform evaluations of Personnel annually and provide documentation of the evaluation to Maxim. If Customer identifies area for improvement for any Personnel, Customer will collaborate with Maxim to provide additional recourses for training and orientation.

Section 4.3 Supplies. Customer will provide all necessary Supplies to Personnel in performance of this Agreement. Customer shall be responsible for disposing of all medical waste and biohazard

produced by the Services and will comply with all applicable local, state, and federal rules, regulations, and laws governing such disposal.

Section 4.4 Float Policy. Subject to prior written notification, Customer may Float Personnel, if Personnel satisfies the Customer's requisite specialty qualifications. If Customer Floats Personnel, the Personnel must perform the duties of the revised assignment as if the revised assignment were the original assignment. Customer will provide the Personnel with additional orientation regarding the Float assignment as necessary. If Personnel Floats to a staff classification that has a lower Base Rate, then the Base Rate that was applicable to the original Personnel assignment remains the applicable Base Rate despite the Float. If Personnel Floats to a staff classification that has a higher Base Rate, then the Base Rate that is applicable to the newly assigned staff classification is the applicable Base Rate for as long as the Personnel continues to work in that staff classification.

Section 4.5 Right to Dismiss. If at any time Customer, in its reasonable judgment, determines that the staffing Services provided any Personnel provided hereunder is inadequate, unsatisfactory or has failed to comply with Customer's rules, regulations, or policies, Customer shall immediately advise Maxim. Maxim will remove Personnel from Customer's School Work Site as requested. Customer will cooperate with Maxim and provide reasonable detail(s) for the dismissal. Customer will provide Maxim with any reports it provides to any governing oversight agency(ies) as a result of Maxim Personnel's conduct, including all drug screens conducted, results of peer review and/or documentation of Customer's investigation.

Section 4.6 Work Environment and OSHA. Customer will provide a clean and properly maintained workspace(s) for Maxim to conduct the Services that will enable Maxim to safely provide Services to student(s). Customer will provide furniture at its sole risk to include, but not limited to, tables and chairs, and allow Personnel reasonable access to telephones for business use. Maxim will not be responsible for the proper maintenance of any property supplied by Customer. Customer will orient Personnel to the specific exposure control plan(s), emergency action plan(s), and/or protocol(s) of the Customer as it pertains to all federal OSHA requirements and equivalent state agency requirements, directives, or standards, with respect to blood borne pathogens, other emergent matters, and any of the Customer's specific policies and procedures for safety, hazardous communications and/or operations instructions. Customer will be responsible for all OSHA recordkeeping, logging, and reporting responsibilities required by law pertinent to Services provided under this Agreement.

Section 4.7 Notification of Incidents and Claims. Customer agrees to notify Maxim of any incident involving Maxim Personnel within forty-eight (48) hours of its occurrence. Customer agrees to provide Maxim documentation of any investigation conducted. Maxim and Customer agree to notify each other in writing of any asserted claim relating to this Agreement within ten (10) days of either discovery of the occurrence upon which the claim may be based or learning of the claim. Indemnity to Customer shall not cover any claims or liabilities in which there is a failure to give the indemnifying party prompt notice of any incident within forty-eight (48) hours of its occurrence.

Section 4.8 Maxim Timeclock. The Parties acknowledge and agree that notwithstanding any Customer manuals, instructions, or other Customer policies, Maxim reserves the right to utilize Maxim Timeclock, a proprietary web-based timekeeping system, for the provision of Services and is not required and/or mandated to use paper-based timekeeping records, unless otherwise required by applicable law. Personnel will submit hours worked to Customer via Maxim Timeclock. Customer will be notified via electronic mail regarding the hours submitted and agrees to review

and approve the submitted hours on a weekly basis, each Monday by noon local time. Customer approved hours will be utilized for the weekly payroll and billing. Any non-approved hours will be discussed between Customer and Maxim; notwithstanding this, Customer and Maxim agree to cooperate in good faith to ensure that all Personnel time is properly captured to ensure compliance with applicable local, state, and federal wage and hour laws.

ARTICLE V. CONVERSION OF PERSONNEL

Section 5.1 Non-Solicitation. For a period of twelve (12) months following the date on which any Personnel either: (i) interviewed with Customer for purposes of Customer qualifying a candidate or applicant for a role or position or (ii) last worked a shift under this Agreement, or a subsequent Assignment through this Agreement, Customer agrees that it will take no steps to solicit, recruit, hire, or employ as its own employees, or as a contractor, those Personnel provided or introduced by Maxim during the term of this Agreement. Customer understands and agrees that Maxim is not an employment agency and that Personnel are assigned to the Customer to render temporary service(s) and are not assigned to become employed by the Customer. Customer further acknowledges and agrees that there is a substantial investment in business related costs incurred by Maxim in recruiting, onboarding, training, and employing Personnel, which necessarily includes recruiting, qualifying, credentialing, training, retaining, and supervising Personnel. In the event that Customer, or any Customer affiliate, subsidiary, department, division, School Work Site, or any other agent of Customer or agent acting on behalf of Customer solicits, hires, or employs any Personnel, Customer will be in material breach of this Agreement.

Section 5.2 Placement Fee. Notwithstanding this Article V, Customer may hire or contract with any Maxim Personnel provided by Maxim if Customer pays Maxim a placement fee equal to the greater of: five thousand dollars (\$5,000) or the sum of thirty percent (30%) of such Personnel's annualized salary (calculated as Weekday Hourly Bill Rate x 1,440 Hours x 30%).

Section 5.3 Breach of Conversion of Personnel Section. In the event that Customer hires or contracts with any Personnel in accordance with the requirements set forth above but does not notify Maxim, the Placement Fee that applies is no less than 150% of that set forth above.

ARTICLE VI. INVOICING, PAYMENT, AND TAXES

Section 6.1 Invoicing. Maxim will supply Personnel under this Agreement at the rate(s) listed in the Attachment(s) to this Agreement. Maxim will submit invoices to Customer every week for Personnel provided to Customer during the preceding week. Customer Invoices shall be submitted to the following electronic mail address or by the applicable agreed upon Timecard Application.

Invoicing E-mail:

Invoicing Contact:

Invoicing Address: 1800 Solar Drive
Oxnard, CA 93030

Section 6.2 Payment. All amounts are due and payable within thirty (30) days from the date of invoice. Maxim's preferred payment is via electronic payment (EFT). If Customer is unable to pay electronically, Customer will send all payments to the address set forth on the invoice. If any portion of an amount billed by Maxim under this Agreement is subject to a good faith dispute between the Parties, Customer shall give written notice to Maxim of the amounts it disputes ("Disputed Amounts") upon the discovery of the billing dispute and include in such written notice the specific details and reasons for disputing each item. Written notice of a dispute must be provided within fourteen (14) days from date of invoice or the invoice amount is presumed to be valid. Customer

shall pay by the due date all undisputed amounts, including, in the event of a billing rate dispute, the amount of the Services at the lower billing rate. Billing disputes shall be subject to the terms of Article XIII, Dispute Resolution.

Section 6.3 Late Payment. Payments not received within thirty (30) days from the applicable invoice date will accumulate interest, until paid, at the rate of one and one-half percent (1.5%) per month on the unpaid balance, equating to an annual percentage rate of eighteen percent (18%), or the maximum rate permitted by applicable law, whichever is less.

Section 6.4 Annual Rate Increases. Customer agrees to and accepts annual rate increases at the percentage listed on "Attachment A" of this Agreement.

Section 6.5 Customer Bankruptcy or Insolvency. Customer agrees that in the event Customer files bankruptcy, (i) to the extent Maxim pays the salary and other direct labor costs of Personnel it provides to Customer and such amounts incurred within one-hundred eighty (180) days prior to bankruptcy are not paid by Customer to Maxim prior to bankruptcy, and/or (ii) Customer is the assignee of claims held by such Personnel against Customer for such amounts incurred within one-hundred eighty (180) days prior to bankruptcy, then Maxim has a claim against Customer in bankruptcy for the amount of such salary and other direct labor costs, which is entitled to a priority under 11 U.S.C. §507(a)(4). All pre-bankruptcy conduct, including amounts due and actions related to payment that could be brought by Customer are released.

Section 6.6 Assurances. In the event Maxim in good faith becomes concerned about impending bankruptcy or other insolvency by Customer, the Parties agree that Maxim may request in writing from Customer a prepayment deposit in the amount equal to the average of two weeks of Services, which Maxim may apply to outstanding invoices in the event that Customer fails to timely pay such invoices. Customer agrees to provide the requested prepayment deposit within five (5) days. In the event that Maxim applies the prepayment deposit in accordance with this Section at such time that concern about Customer's impending insolvency remains, Customer agrees to replenish the prepayment deposit within five (5) days of receipt of written notice of its application.

Section 6.7 Transaction Taxes. Customer shall be responsible for any sales tax, gross receipts tax, excise tax or other state taxes applicable to the Services provided by Maxim. If Customer provides Maxim with a valid tax exemption certificate in accordance with local laws covering the Services provided by Maxim, Maxim will not collect Transaction Taxes.

ARTICLE VII. RELATIONSHIP OF THE PARTIES

Section 7.1 Independent Legal Entities. Maxim and Customer are independent legal entities. Nothing in this Agreement shall be construed to create the relationship of employer and employee, or principal and agent, or any relationship other than that of independent parties contracting with each other solely for the purpose of carrying out the terms of this Agreement. Neither Maxim nor Customer nor any of their respective agents or employees shall control or have any right to control the activities of the other Party in carrying out the terms of this Agreement.

Section 7.2 Use of Contractors. Maxim may utilize the services of Contractors if Customer (i) requests practitioners who are contracted with Maxim Physician Resources, LLC d/b/a Maxim Locum Tenens and Advanced Practitioners in accordance with Article IX hereof; or (ii) in the event Customer makes a request for an urgent volume of staff and the use of Contractors is necessary to meet the requirements under this Agreement. Maxim will ensure that any Contractor Personnel

provided to Customer by a Contractor will comply with the Personnel Requirements set forth in Section 3.2 and timely perform Services under this Agreement.

Section 7.3 Conflict of Interest. By entering into this Agreement, the Parties agree that all conflicts of interest shall and have been disclosed to the other Party for review in accordance with that Party's policies and procedures. A conflict of interest occurs when a Customer employee or Personnel has professional or personal interests that compete with his/her/their ability to provide Services to or on behalf of Maxim or Customer. Such competing interests may make it difficult for the Customer employee or Personnel to fulfill his/her/their duties impartially.

ARTICLE VIII. ASSIGNMENT SERVICES

Section 8.1 Assignment Services. As part of the Services outlined herein, Maxim provides Assignment Services for a specific term and length of the time, and agrees to assign Assignment Personnel to work such specified assignments agreed to and confirmed in writing by the Parties, as set forth in "Attachment C." To the extent Assignment Personnel are utilized for such length and time the terms of Article VIII apply as indicated.

Section 8.2 Interviews. Maxim will provide Customer with Assignment Personnel candidate(s) available to provide Assignment Services, as applicable, and will provide all pertinent information requested by Customer for an interview. Customer has the opportunity and reserves the right to conduct a telephone interview with any Assignment Personnel prior to Assignment Services commencing. Maxim assumes no liability if said Assignment Personnel fail(s) to meet Customer's requirements. Additionally, Customer will not be relieved of paying Maxim the established fees set forth in this Agreement for said Assignment Services.

Section 8.3 Assignment Cancellation by Maxim. Maxim reserves the right to cancel the term of Assignment Personnel with written notification to Customer. Maxim will endeavor to provide a qualified replacement for cancelled Assignment Personnel within fourteen (14) days from the date of notification.

Section 8.4 Assignment Cancellation by Customer. Customer agrees to utilize Assignment Personnel for the specified period of time outlined in the "Attachment C" Assignment Confirmation. Should Customer staffing needs change and Customer wishes to cancel Assignment Personnel already being utilized on contract, Customer must give Maxim fourteen (14) days' notice before cancellation date. If Customer does not provide required notice, Customer will be required to pay Maxim a fee equal to: the sum of seventy-two (72) hours of such Assignment Personnel's rate subtracted by any hours worked by Assignment Personnel after notice is given (calculated as Assignment Bill Rate x 72 Hours - Hours Worked after cancellation notice).

Section 8.5 Assignment Confirmations. Each Assignment Services request will be confirmed in writing with the applicable Base Rate or Assignment Personnel Rate to be charged for Assignment Personnel to work a specific assignment set forth in Assignment Confirmations as "Attachment C." Hourly rates include reimbursement for ordinary and necessary travel expense for meals incurred by Assignment Personnel, as accounted for on the invoice or periodic statement, where Customer is acknowledged to be subject to limitation on deduction under IRC § 274 and related regulations. As needed, Customer should request information beyond the accounting provided to comply with their obligation(s). If there is any conflict between this Agreement and any Assignment Confirmation(s) and/or Attachment(s), the terms of the Assignment Confirmation(s) will govern.

Section 8.6 Assignment Confirmation Delivery. Assignment Confirmations will be sent via electronic mail, or other means as agreed upon by the Customer and Maxim. In the event that Customer fails to respond to the Assignment Confirmation within forty-eight (48) hours, the Customer will be deemed to have accepted the terms in said Assignment Confirmation and Customer will assume responsibility for any applicable payment terms as outlined in the Assignment Confirmation. Should a dispute arise, the Assignment Confirmation shall supersede any and all prior oral and written understandings.

ARTICLE IX. ADDITIONAL SERVICES

Section 9.1 Locum Tenens Coverage. Should Customer request Locum Tenens coverage from Maxim, the Parties shall enter into a separate Service Agreement for Locum Tenens Coverage in the form of Attachment [] (if applicable). The terms set forth in Attachment [] will govern the provided Locum Tenens services and are incorporated herein by this reference.

Section 9.2 MaxView and Workforce Solutions. Should Customer request utilization of Maxim's workforce technology solution, MaxView in conjunction with providing Personnel under this Agreement the Parties shall enter into a separate Service Agreement for MaxView in the form of Attachment []. The terms set forth in Attachment [] (if applicable) will govern the provided utilization of MaxView, along with any applicable terms and conditions and terms of use and are incorporated herein by this reference.

ARTICLE X. INSURANCE

Section 10.1 Maxim Insurance. Maxim will maintain (at its sole expense), or require the Contractors it utilizes under this Agreement to maintain, valid policies of insurance evidencing general and professional liability coverage of not less than \$1,000,000 per occurrence and \$3,000,000 in the aggregate, covering temporary staffing Services provided by Personnel. Maxim will provide a certificate of insurance evidencing such coverage upon written request by Customer.

Section 10.2 Customer Insurance. Customer will maintain at its sole expense valid policies of general and professional liability insurance with minimum limits of \$1,000,000 per occurrence and \$3,000,000 annual aggregate. Customer will give Maxim prompt written notice of any material change in Customer coverage. Customer shall name Maxim as an additional insured on its general liability policy.

ARTICLE XI. INDEMNIFICATION

Section 11.1 Indemnification by Maxim. Maxim agrees, at its own expense, to indemnify, defend, and hold harmless Customer and its parent, subsidiaries, Affiliates, directors, officers, employees, and agents against any and all third-party losses, liabilities, judgments, awards, and costs (including reasonable attorneys' fees and expenses) to the extent arising out of or relating to:

(a) bodily injury (including death) or any real or tangible property loss or damage as a direct result of Maxim's employees' negligent acts or omissions in the performance of Services under this Agreement; or

(b) any breach by Maxim of Section 3.2 or Section 3.3.

Section 11.2 Indemnification by Customer – Customer agrees, at its own expense, to indemnify, defend, and hold harmless Maxim and its parent, subsidiaries, affiliates, directors, officers, employees, and agents against any and all third-party losses, liabilities, judgments, awards, and costs (including reasonable attorneys’ fees and expenses) to the extent arising out of or relating to:

(a) bodily injury (including death) or any real or tangible property loss or damage as a direct result of Customer’s employees’ negligent acts or omissions in the performance of Services under this Agreement; or

(b) any Transaction Taxes levied, assessed, or imposed by any taxing authority as a result of, or in connection with this Agreement, whatever the source and regardless of whether invoiced to or remitted by Customer.

Section 11.3 Indemnification Procedures – The Party seeking indemnification under this Article XI (the “**Indemnified Party**”) shall notify the other Party (the “**Indemnifying Party**”) promptly after the Indemnified Party receives notice of a claim for which indemnification is sought under this Agreement; provided, however, that no failure to so notify the Indemnifying Party shall relieve the Indemnifying Party of its obligations under this Agreement except to the extent that it can demonstrate damages directly attributable to such failure. To the extent permitted by law, the Indemnifying Party shall have authority to defend or settle the claim; provided, however, that the Indemnified Party, at its sole discretion and expense, shall have the right to participate in the defense and/or settlement of the claim, and provided further, that the Indemnifying Party shall not settle any such claim imposing any liability or other obligation on the Indemnified Party without the Indemnified Party’s prior written consent.

ARTICLE XII. LIMITATION OF LIABILITY

Section 12.1 Limitation on Liability. Intentionally omitted.

Section 12.2 Cap on Damages. Intentionally omitted.

ARTICLE XIII. DISPUTE RESOLUTION

Section 13.1 Dispute Resolution. Except as otherwise provided in this Agreement, any dispute between the Parties regarding the interpretation or enforcement of this Agreement or any of its terms shall be addressed by good faith negotiation between the Parties.

Section 13.2 Dispute Resolution Process. To initiate such negotiation, a Party must provide to the other Party written notice of the dispute that includes both a detailed description of the dispute or alleged nonperformance and the name of an individual who will serve as the initiating Party’s representative in the negotiation. The other Party shall have ten (10) business days to designate its own representative in the negotiation. The Parties’ representatives shall meet at least once within forty-five (45) days after the date of the initiating Party’s written notice in an attempt to reach a good faith resolution of the dispute. Upon agreement, the Parties’ representatives may utilize other alternative dispute resolution procedures such as private mediation to assist in the negotiations.

Section 13.3 Inability to Resolve. If the Parties have been unable to resolve the dispute within forty-five (45) days of the date of the initiating Party’s written notice, either Party may pursue any remedies

available to it under this Agreement, at law, in equity, or otherwise, including, but not limited to, instituting an appropriate proceeding before a court of competent jurisdiction.

ARTICLE XIV. CONFIDENTIALITY AND USAGE OF DATA

Section 14.1 Confidentiality.

A. Maxim/Customer Information. Subject to applicable intellectual property federal law(s), the Parties recognize and acknowledge that, by virtue of entering into this Agreement and providing Services hereunder, the Parties will have access to certain information of the other Party that is confidential and constitutes valuable, special, and unique property of the Party, and may be classified as trade secret or proprietary information. Each of the Parties agree that neither it nor its staff shall, at any time either during or subsequent to the term of this Agreement, disclose to others, use, copy, or permit to be copied, except pursuant to its duties for or on behalf of the other Party, any secret or confidential information of the Party, including, without limitation, information with respect to the Party's customers, cost structure, and/or business strategy or business methods at any time used, developed, or made by the Party during the term of this Agreement and that is not available to the public, without the other Party's prior written consent.

B. Disclosure of Maxim/ Customer Partnership. From time to time, Maxim lists or mentions its customers in its marketing, communication, and business initiatives barring any restrictions and obligations as set forth in Section 14.1(C) and/or Section 14.2 of this Agreement. Customer agrees that Maxim may disclose the partnership between Maxim and Customer, and use Customer's name for such marketing, communication, and business purposes and initiatives. The Parties will make all commercially reasonable efforts to facilitate and coordinate press announcements, press releases, and other joint-marketing efforts related to this Agreement and the Maxim/Customer partnership. If either Party reasonably objects to use or disclosure of said partnership in such initiative(s), the other Party may ask the Party that developed the marketing or promotional content to edit or adjust such materials, and such Party will not unreasonably disagree.

C. Student Information: In the event that Maxim receives student information, including student financial or medical information, Maxim shall not disclose any individual student records, including student financial or medical information for which Services are provided under this Agreement to any third-party, except where permitted or required by law or where such disclosure is expressly approved by Customer, Maxim, and if required, student in writing. Further, each Party and its employees shall comply with the other Party's policies and obligations. Maxim may maintain and use Student Education Records to perform the Services under this Agreement and may disclose de-identified data to third parties in performance of services under this Agreement. If Maxim is provided access to students' records, Maxim shall limit its personnel's access to the records to those persons for whom access is essential to the performance of the Services under this Agreement. Maxim shall, at all times and in all respects, comply with the terms of the Family Rights and Privacy Act of 1974, as amended. Maxim reserves the right to retain any Student Education Records for the length of time necessary to meet Maxim's contractual and legal commitments.

D. The obligations set forth in this Article XIV shall survive the termination of this Agreement.

Section 14.2 Data Security. Customer will be responsible for establishing and overseeing all access, maintenance, and transmission of Customer and Student data and information, including privacy and security measures required under Law, which may further be needed to maintain and

protect the security of all computer systems, networks, and/or data related to the services under this Agreement. Customer will be responsible for providing all education and training to Personnel as it relates to Customer's privacy and security measures and processes, including, without limitation the Customer's processes and expectations for collecting, storing, securing, and transferring Customer or Student data and information accessed, collected, and maintained under this Agreement.

Customer acknowledges and understands and agrees that no Personally identifiable information ("PII") or Protected Health Information ("PHI") PHI will be relayed, transmitted, or otherwise provided to or stored by Maxim or Maxim Personnel, unless necessary to be provided in performance of Services under this Agreement. Customer further acknowledges that it will provide Maxim with deidentified data, whenever possible, including removal of direct identifiers. Customer shall indemnify and hold harmless Maxim, its directors, officers, shareholders, employees, and agents from and against any and all claims, losses, liabilities, costs and other expenses resulting from, or relating to, the negligent handling of PII or PHI, including the unauthorized use, access, or disclosure by Customer, its employees, agents, and subcontractors.

Section 14.3 Aggregate Statistical Usage. Customer acknowledges and agrees that Maxim will collect data related to the performance of the Services for the purposes of aggregation and the creation of a centralized benchmarking mechanism. Notwithstanding anything to the contrary in this Agreement, Customer acknowledges and agrees that Maxim shall have a perpetual right to collect, use, and disclose the data collected relating to the Services and derived from Customer's use of Maxim, Maxim Personnel, and Contractors affiliated with Maxim under this Agreement for the analysis, benchmarking, analytics, marketing, or other business purposes as long as all data collected is done in an anonymized aggregated manner, with Customer's data aggregated with data of other Maxim customers, so as to be non-specific to any individual Customer.

ARTICLE XV. TERMINATION

Section 15.1. Termination for Convenience. Either Party may terminate this Agreement for any reason by providing at least thirty (30) days advance written notice of the termination date to the other Party.

Section 15.2 Termination for Cause. If payment default occurs, Maxim may terminate this Agreement upon seven (7) days advance written notice of the termination date to Customer.

Section 15.3 Post Termination Obligations. Termination will have no effect upon the rights and obligations resulting from any transactions occurring prior to the effective date of the termination.

ARTICLE XVI. GENERAL TERMS

Section 16.1 Non-discrimination. Neither Maxim nor Customer will discriminate on the basis of race, color, religion, creed, national origin or ancestry, ethnicity, sex (including gender, pregnancy, sexual orientation, and gender identity), age, physical or mental disability, citizenship, past, current, or prospective service in the uniformed Services, genetic information, or any other characteristic protected under applicable federal, state, or local law.

Section 16.2 Compliance with Laws. Maxim agrees that all Services provided pursuant to this Agreement shall be performed in compliance with all applicable federal, state, and/or local rules and regulations. In the event that applicable federal, state, or local laws and regulations or applicable accrediting body standards are modified, Maxim reserves the right to notify Customer in writing of any modifications to the Agreement in order to remain in compliance with such law, rule, or regulation.

Section 16.3 Governing Law, Jurisdiction. This Agreement will be governed by and construed in accordance with the laws of the State of Maryland, without regard to its principles of conflict of laws. Any dispute or claim from this Agreement shall be resolved exclusively in the federal and state courts of the State of Maryland and the parties hereby irrevocably submit to the personal jurisdiction of said courts and waive all defenses thereto.

Section 16.4 Assignment of Agreement. Customer may not assign this Agreement without the prior written consent of Maxim, and such consent will not be unreasonably withheld. Maxim may assign this Agreement without consent and/or notice for assignment to either: (i) an entity owned by or under common control with assignor, (ii) in connection with any acquisition of all of the assets or capital stock of Maxim, and/or (iii) a name change by Maxim.

Section 16.5 Attorneys' Fees. In the event either Party is required to obtain legal assistance (including in-house counsel) to enforce its rights under this Agreement, or to collect any monies due to such Party for Services provided, the prevailing Party shall be entitled to receive from the other Party, in addition to all other sums due, reasonable attorney's fees, court costs, and expenses, if any, incurred enforcing its rights and/or collecting its monies, including any fees and costs incurred on an appeal.

Section 16.6 Notices. Any notice or demand required under this Agreement will be in writing; will be personally served or sent by certified mail, return receipt requested, postage prepaid, or by a recognized overnight carrier which provides proof of receipt; and will be sent to the addresses below. Either Party may change the address to which notices are sent by sending written notice of such change of address to the other Party.

Rio School District
1800 Solar Drive
Oxnard, CA 93030
ATTN: Admin

Maxim Healthcare Staffing Services, Inc.
7227 Lee DeForest Drive
Columbia, MD 21046
ATTN: Contracts Department
Email copy to:
ContractsEducationalServices@maxhealth.com

COPY TO:

Maxim Healthcare Staffing Services, Inc.
735 Tank Farm Road Ste 140
San Luis Obispo, CA 93401
ATTN: **Mark Wrightson**

Section 16.7 Headings. The headings of sections and subsections of this Agreement are solely for reference only and will neither affect nor control the meaning or interpretation of this Agreement.

Section 16.8 Merger. This Agreement constitutes the entire contract between Customer and Maxim regarding the Services to be provided hereunder. Any agreements, promises, negotiations, or representations not expressly set forth in this Agreement are of no force or effect. All terms of a later signed Agreement will supersede a prior signed Agreement. This Agreement may be executed in any number of counterparts, each of which will be deemed to be the original, but all of which shall constitute one and the same document.

Section 16.9 Amendment. No changes and/or amendments to this Agreement will be effective unless made in writing and signed by duly authorized representatives of both Parties except as provided in Section 3.1(a), Section 16.2, and Attachment(s).

Section 16.10 Severability. In the event that one or more provision(s) of this Agreement is deemed invalid, unlawful, and/or unenforceable, then only that provision will be omitted, and will not affect the validity or enforceability of any other provision; the remaining provisions will be deemed to continue in full force and effect.

Customer and Maxim have acknowledged their understanding of and agreement to the mutual promises written above by executing and delivering this Agreement as of the date set forth

RIO SCHOOL DISTRICT:

MAXIM HEALTHCARE STAFFING SERVICES, INC.:

Signature of Authorized Representative

Signature of Authorized Representative

Printed Name & Title

Printed Name & Title

Date

Date

ATTACHMENT "A"
CUSTOMER REQUESTED PERSONNEL AND RATES – 7/1/2022

School Work Site. This "Attachment A" shall apply to the following School Work Site(s):

School Work Site Name	Address	School Work Site Contact
All Sites		

Base Rates. Base Rates for the following positions shall apply. Where Base Rate on "Attachment C" is differing, "Attachment C" shall control.

Positions	Rate (per hour)
BCBA	\$120-\$130
BCaBA	\$90
Behavior Tech	\$52
LVN	\$60-\$70
Para Educator/Instructional Aide	\$36
CNA	\$45
PT/OT	\$100-\$115
COTA	\$70
RN	\$85-\$105
School Psychologist	\$120-\$130
SLP	\$110-\$120
SLPA	\$70
Social Worker	\$90-\$100
SPED Teacher	\$80-\$90

Annual Rate Increase. Effective on the Agreement renewal date and every year thereafter, base rates for all modalities listed above will be increased by three percent (3%) of Base Rate(s).

Weekend. Weekend rates will apply to shifts beginning at 11:00 p.m. on Friday and will apply through shifts ending at 7:00 a.m. on Monday.

Orientation. Base Rate(s) will be billed for all time spent in required Customer orientation.

Overtime. Overtime Rates are charged for all hours worked in excess of forty (40) per week or according to applicable state law. The overtime rate is a one and one-half times (1.5x) multiplier of the Base Rate for such hours, unless applicable state law requires a different multiplier.

Holidays. Holiday Rates will apply to shifts beginning at 11:00 p.m. the night before the holiday through 11:00 p.m. the night of the holiday. The Holiday rate is a one and one-half times (1.5x) multiplier of the Base Rate for the following holidays:

New Year's Day	Labor Day
Memorial Day	Thanksgiving Day
Independence Day	Christmas Day

Changes. Pursuant to Section 3.1(c) of the Agreement, the Parties agree that Changes may be made to "Attachment A" by execution of subsequent "Attachment A" document(s).

Attachment "B"
PRE-ASSIGNMENT SCREENING

- I. **School Health Services, Related Services, and Special Education Personnel Requirements.** Maxim will supply Customer with School Health Services, Related Services and Special Education Services Personnel requested in Attachment "A" who meet the following criteria, if the role involves the provision of health and mental health services. These roles include but are not limited to: RN Certified Nurse, RN School, BCBA, Behavior Tech, Occupational Therapist, Occupational Therapy Assistant, Physical Therapist, Physical Therapist Assistant, Psychologist. Customer agrees any additional screening that may be required not listed herein, may take place following Personnel's placement. Maxim will:
 - a. Conduct a criminal background screening in accordance with applicable law;
 - b. Verify current license, registration, or certification, including CPR, for the Services to be provided, if applicable to role;
 - c. Skills assessment checklist of competencies for the position and an exam, if applicable
 - d. Verify that a current diagnostic Tuberculosis (TB) test or screening is on file;
 - e. Verify relevant professional and specialty expertise as requested by Customer;
 - f. Receive employment verification;
 - g. Confirm Personnel are authorized to work;
 - h. Perform federal exclusion and abuse check(s) including but not limited to, List of Excluded Individuals/Entities (LEIE) and the Excluded Parties List System (EPLS) and the National Sex Offender Registry.

- II. **Education Personnel Requirements.** Maxim will supply Customer with requested Related Services Personnel in Attachment "A" performing education services who meet the following criteria. These roles include but are not limited to the following: Special Education Teacher, Social Worker, School Counselor, Sign Language Interpreter, Admin Teacher Orientation and Mobility, Behavioral Classroom Aide (WA), Speech Language Pathologist. Customer agrees any additional screening that may be required not listed herein, may take place following Personnel's placement. Maxim will:
 - a. Conduct a criminal background screening in accordance with applicable law;
 - b. Receive employment verification;
 - c. Verify, license, certification or certification, if applicable to the role;
 - d. Verify relevant professional and specialty expertise as requested by Customer;
 - e. Confirm Personnel are authorized to work;
 - f. Perform federal exclusion checks including but not limited to, List of Excluded Individuals/Entities (LEIE), Excluded Parties List System (EPLS) and the National Sex Offender Registry.

- III. **Customer Criminal Background Report.** In the event that Customer requires its own criminal background screening for Maxim Personnel, Customer shall provide Maxim with a copy of the results and/or report, or the "Clear" or "Not Clear" status. Customer agrees

that Personnel may begin assignment following completion of a successful Customer background screening.

**ATTACHMENT "C"
ASSIGNMENT CONFIRMATION**

Maxim and Customer hereby agree the following Personnel will be assigned to Customer's Work Site, listed below, under the terms and conditions outlined below and according to the Agreement signed between Customer and Maxim.

Customer and Maxim understand and agree that this assignment is contingent upon verification of Personnel's compliance with the Agreement and the pre-assignment screening requirements in "Attachment B" prior to the assigned start date. To the extent that the rates set forth herein differ from the rates in "Attachment A" the rates set forth herein shall govern for the length of the Assignment start and end dates, and with renewal of the Agreement.

Customer Name:	
School Work Site Address:	
Confirmation Date:	

Customer hereby agrees to sign/return this document **WITHIN 48 BUSINESS HOURS** of the date listed above and understands that failure to do so may result in the delay of the assignment start date, and/or additional charges as defined in the Agreement.

Personnel Name, Discipline:	
Assigned Unit/Department:	
Float Requirement:	

Assignment Start Date:	
Assignment End Date:	
Guaranteed Weekly Hours/Schedule:	
Approved Time-Off:	

Base Bill Rate:	
Overtime and Holiday Rates:	
On Call/Call Back Rates:	
Approved Orientation Rate/Hrs.:	
Special Provisions:	

Authorized signature below indicates agreement to utilize Maxim Personnel under of ALL of the conditions specified above. The Staffing Services Agreement between Customer and Maxim shall govern any/all additional provisions that affect this assignment and/or the business relationship between the parties.

Authorized Customer Representative Signature

Printed Name & Title

Date

Please email a signed copy of this confirmation back to E-MAIL ADDRESS. Thank you.



MAXIM/TRAVELMAX ASSIGNMENT CONFIRMATION

MAXIM/TRAVELMAX and Rio School District hereby agree to employ the following personnel under the terms and conditions outlined below and according to the staffing agreement signed between facility and TravelMax.

Rio School District and MAXIM/TRAVELMAX understand and agree that this assignment is contingent upon verification of said personnel's compliance with MAXIM/TRAVELMAX and Rio School District credentialing requirements prior to the assigned start date.

Facility Name:	Rio School District
Facility Address:	1800 Solar Drive, Oxnard, Ca 93030
Confirmation Date:	6/16/2022
New Contract or Existing:	New Master Client, if applies:
VMS Platform Used:	N/A
Compliance File Due Date:	N/A

Rio School District hereby agrees to sign/return this document **WITHIN 48 BUSINESS HOURS** of date listed above and understands that failure to do so may result in the delay of the assignment start date.

Candidate Name, Discipline:	Maybelle Natividad, LVN
Assigned Unit/Department:	School
Float Requirement:	N/A

Assignment Start Date:	8/23/2022
Assignment End Date:	6/15/2023
Shift Schedule:	M-F
Guaranteed Weekly Hours:	30 Weekly hours
Approved Time-Off:	N/A

Hourly Bill Rate:	\$60 per hour
Overtime and Holiday:	\$90 per hour
Rebate/Discount:	0%
On Call Rate:	\$N/A per hour to hold beeper
Call Back Rate:	\$N/A per hour for all call back hours
Holiday Provisions:	per contract
Non-Billable Orientation Hours:	0 hours
Cancellation Policy:	Client may cancel N/A shift every N/A weeks

Authorized signature below indicates Rio School District's agreement to employ MAXIM/TRAVELMAX personnel under of ALL of the conditions specified above. The master agreement for services between Rio School District and MAXIM/TRAVELMAX shall govern any/all additional provisions that affect this assignment and/or the business relationship between the parties.

Authorized Client Signature

Maxim/TravelMax Office Signature

Printed Name & Title

Printed Name & Title

Date

Date

Please sign and email to mawrights@maxlmstaffing.com or you can fax to 866-250-8915 . Thank you.



MAXIM/TRAVELMAX ASSIGNMENT CONFIRMATION

MAXIM/TRAVELMAX and Rio School District hereby agree to employ the following personnel under the terms and conditions outlined below and according to the staffing agreement signed between facility and TravelMax.

Rio School District and MAXIM/TRAVELMAX understand and agree that this assignment is contingent upon verification of said personnel's compliance with MAXIM/TRAVELMAX and Rio School District credentialing requirements prior to the assigned start date.

Facility Name:	Rio School District
Facility Address:	1800 Solar Drive, Oxnard, Ca 93030
Confirmation Date:	6/16/2022
New Contract or Existing:	New Master Client, if applies:
VMS Platform Used:	N/A
Compliance File Due Date:	N/A

Rio School District hereby agrees to sign/return this document **WITHIN 48 BUSINESS HOURS** of date listed above and understands that failure to do so may result in the delay of the assignment start date.

Candidate Name, Discipline:	Elisa Iniguez, LVN
Assigned Unit/Department:	School
Float Requirement:	N/A

Assignment Start Date:	8/23/2022
Assignment End Date:	6/15/2023
Shift Schedule:	M-F
Guaranteed Weekly Hours:	30 Weekly hours
Approved Time-Off:	N/A

Hourly Bill Rate:	\$60 per hour
Overtime and Holiday:	\$90 per hour
Rebate/Discount:	0%
On Call Rate:	\$N/A per hour to hold beeper
Call Back Rate:	\$N/A per hour for all call back hours
Holiday Provisions:	per contract
Non-Billable Orientation Hours:	0 hours
Cancellation Policy:	Client may cancel N/A shift every N/A weeks

Authorized signature below indicates Rio School District's agreement to employ MAXIM/TRAVELMAX personnel under of ALL of the conditions specified above. The master agreement for services between Rio School District and MAXIM/TRAVELMAX shall govern any/all additional provisions that affect this assignment and/or the business relationship between the parties.

Authorized Client Signature

Maxim/TravelMax Office Signature

Printed Name & Title

Printed Name & Title

Date

Date

Please sign and email to mawrights@maximstaffing.com or you can fax to 866-250-8915 . Thank you.



**MAXIM/TRAVELMAX
ASSIGNMENT CONFIRMATION**

MAXIM/TRAVELMAX and Rio School District hereby agree to employ the following personnel under the terms and conditions outlined below and according to the staffing agreement signed between facility and TravelMax.

Rio School District and MAXIM/TRAVELMAX understand and agree that this assignment is contingent upon verification of said personnel's compliance with MAXIM/TRAVELMAX and Rio School District credentialing requirements prior to the assigned start date.

Facility Name:	Rio School District
Facility Address:	1800 Solar Drive, Oxnard, Ca 93030
Confirmation Date:	6/16/2022
New Contract or Existing:	New Master Client, if applies:
VMS Platform Used:	N/A
Compliance File Due Date:	N/A

Rio School District hereby agrees to sign/return this document **WITHIN 48 BUSINESS HOURS** of date listed above and understands that failure to do so may result in the delay of the assignment start date.

Candidate Name, Discipline:	Angelica Cuellar, LVN
Assigned Unit/Department:	School
Float Requirement:	N/A

Assignment Start Date:	8/23/2022
Assignment End Date:	6/15/2023
Shift Schedule:	M-F
Guaranteed Weekly Hours:	30 Weekly hours
Approved Time-Off:	N/A

Hourly Bill Rate:	\$60 per hour
Overtime and Holiday:	\$90 per hour
Rebate/Discount:	0%
On Call Rate:	\$N/A per hour to hold beeper
Call Back Rate:	\$N/A per hour for all call back hours
Holiday Provisions:	per contract
Non-Billable Orientation Hours:	0 hours
Cancellation Policy:	Client may cancel N/A shift every N/A weeks

Authorized signature below indicates Rio School District's agreement to employ MAXIM/TRAVELMAX personnel under of ALL of the conditions specified above. The master agreement for services between Rio School District and MAXIM/TRAVELMAX shall govern any/all additional provisions that affect this assignment and/or the business relationship between the parties.

Authorized Client Signature

Maxim/TravelMax Office Signature

Printed Name & Title

Printed Name & Title

Date

Date

Please sign and email to mawrights@maximstaffing.com or you can fax to **866-250-8915** . Thank you.



**MAXIM/TRAVELMAX
ASSIGNMENT CONFIRMATION**

MAXIM/TRAVELMAX and Rio School District hereby agree to employ the following personnel under the terms and conditions outlined below and according to the staffing agreement signed between facility and TravelMax.

Rio School District and MAXIM/TRAVELMAX understand and agree that this assignment is contingent upon verification of said personnel's compliance with MAXIM/TRAVELMAX and Rio School District credentialing requirements prior to the assigned start date.

Facility Name:	Rio School District
Facility Address:	1800 Solar Drive, Oxnard, Ca 93030
Confirmation Date:	6/16/2022
New Contract or Existing:	New Master Client, if applies:
VMS Platform Used:	N/A
Compliance File Due Date:	N/A

Rio School District hereby agrees to sign/return this document **WITHIN 48 BUSINESS HOURS** of date listed above and understands that failure to do so may result in the delay of the assignment start date.

Candidate Name, Discipline:	Rosalba Camarillo, LVN
Assigned Unit/Department:	School
Float Requirement:	N/A

Assignment Start Date:	8/23/2022
Assignment End Date:	6/15/2023
Shift Schedule:	M-F
Guaranteed Weekly Hours:	40 Weekly hours
Approved Time-Off:	N/A

Hourly Bill Rate:	\$60 per hour
Overtime and Holiday:	\$90 per hour
Rebate/Discount:	0%
On Call Rate:	\$N/A per hour to hold beeper
Call Back Rate:	\$N/A per hour for all call back hours
Holiday Provisions:	per contract
Non-Billable Orientation Hours:	0 hours
Cancellation Policy:	Client may cancel N/A shift every N/A weeks

Authorized signature below indicates Rio School District's agreement to employ MAXIM/TRAVELMAX personnel under of ALL of the conditions specified above. The master agreement for services between Rio School District and MAXIM/TRAVELMAX shall govern any/all additional provisions that affect this assignment and/or the business relationship between the parties.

Authorized Client Signature

Maxim/TravelMax Office Signature

Printed Name & Title

Printed Name & Title

Date

Date

Please sign and email to mawrights@maximstaffing.com or you can fax to **866-250-8915** . Thank you.

9.24



Agenda Item Details

Meeting	Jun 29, 2022 - RSD Regular Board Meeting
Category	9. Consent
Subject	9.24 Approval of Ventura County Indian Education Consortium MOU
Access	Public
Type	Action (Consent)
Fiscal Impact	Yes
Dollar Amount	1,991.57
Budgeted	Yes
Budget Source	LCFF Funds
Recommended Action	Staff recommends board approval of VCIEC MOU for the 2022-2023 school year.
Goals	<p>Goal 3-Create welcoming and safe environments where students attend and are connected to their school</p> <p>Goal 1-Improved student achievement at every school and every grade in all content areas</p>

Public Content

Speaker: Oscar Hernandez, Asst. Superintendent Educational Services

Rationale:

The Indian Education Act of 1972 (Public Law 100-427) enabled local agencies throughout the United States to identify their Indian student populations, establish parent committees, hold public hearings, and write grants identifying the needs of Indian students who will participate in their programs. This law provides local school districts with additional monies to provide over and beyond educational and culturally-related services to identified Indian students, at no additional cost to the district in the Consortium.

Rio School District Indian Education student count for the 2021-2022 school year was seven students.

The district will provide a total of \$1991.57 in funding for the 2022-2023 school year.

Ventura County Indian Education Consortium MOU.pdf (923 KB)

Administrative Content

Executive Content

Our adopted rules of Parliamentary Procedure, Robert's Rules, provide for a consent agenda listing several items for approval of the Board by a single motion. Most of the items listed under the consent agenda have gone through Board subcommittee review and recommendation. Documentation concerning these items has been provided to all Board members and the public in advance to assure an extensive and thorough review. Items may be removed from the consent agenda at the request of any board member.

MEMORANDUM OF UNDERSTANDING
Ventura County Indian Education Consortium

This Memorandum of Understanding (MOU) explains and confirms the agreements between the Ventura Unified School District as the Local Education Agency for the Ventura County Indian Education Consortium (Provider) and the Rio School District (Partner District).

Memorandum of Understanding Purpose:

The purpose of this MOU is to create and confirm an effective working relationship between the Partner District, **Rio School District**, and the Ventura Unified School District (VUSD). This MOU also provides the means by which VUSD and the Partner District will maintain a collaborative relationship to ensure inter-agency services to Partner District students and families.

Memorandum of Understanding Timeline:

This MOU is effective July 1, 2022 and will extend through June 30, 2023.

Memorandum of Understanding and Description of Services:

Partner District agrees to the following:

1. Serve as a consortium partner to raise awareness regarding Indian Education.
2. Assist in the recruitment of eligible Indian Education students through existing district means of communication.
3. Confirm student enrollment for annual Title VI grant submission of student count.
4. Identify district and site contact personnel to facilitate communication with the VC Indian Education Consortium as required.
5. Provide classroom space or other school facilities to accommodate Indian Education lessons.
6. Be responsible for safeguarding participant information in compliance with Title 42 Code of Federal Regulations, Part 2.
7. Inform VUSD of changes in schedule and student participation.
8. Work with the VUSD staff as needed.

VUSD (Provider) agrees to the following:

1. Serve as Local Education Agency for VC Indian Education Consortium.
2. Hire all employees to provide Indian Education services.
3. Provide basic services to eligible Indian Education students including:
 - a) Indian Education Parent Advisory Committee
 - b) Indian Education enrollment and verification support
 - c) Indian Education Annual Honoring Ceremony and Events
 - d) Indian Education teaching resources/lending library
 - e) Indian Education teacher workshops to introduce teaching resources and annual curriculum theme. The theme for 2022 – 23 is “Notable Native American Leaders- Part 1”

4/11/2022

4. Provide services at Partner District schools through the district-supported format to include:
 - a) Individual/small group lessons to support cultural identity and awareness for eligible Native American students (as in the past); or
 - b) Classroom presentations on Native American themes (to include classmates of identified students).
5. Ensure that VUSD employees have received adequate training in the services being provided and appropriate licenses/certificates are in current standing.
6. Ensure that VUSD employees have completed an appropriate background check, including fingerprinting/live scan as described below.

Both the Partner District and VUSD representatives of the VC Indian Education Consortium will agree on all elements of any program prior to implementation. Any potential funding issues that are not cost neutral are required to be approved by the VUSD District Office Administration prior to program implementation.

Payment of Funds to VUSD for VC Indian Education Consortium Services:

The Partner District, Rio School District, agrees to contribute \$1,991.57 to VUSD for Indian Education services provided during the 2022-23 school year. Payment to VUSD will occur by September 30 upon receipt of an invoice from VUSD.

Indemnification:

The Partner District shall save, defend, hold harmless and indemnify VUSD (its employees, volunteers, officers, directors and agents), from and against any and all losses, damages, liabilities, claims, and costs of whatsoever kind and nature for injury to or death of any person and for loss or damage to any property arising from all acts or omissions to act of the Partner District or its board members, officers, employees, volunteers or agents occurring in connection with or in any way incident to or arising out of this Agreement except for liability resulting from the active negligence, sole negligence or willful misconduct of VUSD.

VUSD shall save, defend, hold harmless and indemnify the Partner District (District, board members, employees, volunteers and agents), from and against any and all losses, damages, liabilities, claims, and costs of whatsoever kind and nature for injury to or death of any person and for loss or damage to any property arising from all acts or omissions to act of Provider or its employees, volunteers, officers, directors or agents occurring in connection with or in any way incident to or arising out of this Agreement except for liability resulting from the active negligence, sole negligence or willful misconduct of the Partner District.

Cancellation:

This MOU may be cancelled by either party upon 30 days written notice.

Signatures:

PARTNER DISTRICT: Rio School District

Authorized District Representative: _____

Signature: _____

Title: _____

Date: _____

PROVIDER: Ventura Unified School District

Authorized Representative: Dr. Rebacca Chandler

Signature:  _____

Title: Assistant Superintendent, Business Services

Date: 4/12/22

9.25



Agenda Item Details

Meeting	Jun 29, 2022 - RSD Regular Board Meeting
Category	9. Consent
Subject	9.25 Approval of the The Stepping Stones Group Contract
Access	Public
Type	Action (Consent)
Fiscal Impact	Yes
Dollar Amount	118,800.00
Budgeted	Yes
Budget Source	LCFF One-time funds
Recommended Action	Staff recommends board approval of the Stepping Stones Group Contract to Provide Additional LVNs

Public Content

Speaker: Nadia Villapudua, Director of Pupil Personnel Services

Rationale:

Two Licensed Vocational Nurses (LVNs) are needed to assist and support with the implementation of COVID-19 site safety measures, procedures and protocols and support the health needs of students during school hours and afterschool programs. The Stepping Stones Group is an additional staffing agency partner that supports when Maxim staffing agency is not able to meet the current staffing needs.

Contracted LVNs are held to the same standard as district employees and will be provided training to ensure that they are able to deliver appropriate health related services in accordance to our district protocols. Contracted LVNs will attend regular district trainings in order to build rapport within the Rio School District

[Stepping Stones Contract for LVN \(22-23\) for board.pdf \(159 KB\)](#)

Administrative Content

Executive Content

Our adopted rules of Parliamentary Procedure, Robert's Rules, provide for a consent agenda listing several items for approval of the Board by a single motion. Most of the items listed under the consent agenda have gone through Board subcommittee review and recommendation. Documentation concerning these items has been provided to all Board members and the public in advance to assure an extensive and thorough review. Items may be removed from the consent agenda at the request of any board member.



AGREEMENT

This Agreement is made and entered on June 15, 2022 by and between The Stepping Stones Group LLC, 123 N Wacker Drive, Chicago, IL 60606 hereinafter referred to as "Contractor" and, Rio Elementary School District, Oxnard, CA 93030, hereinafter referred to as "School District." It is hereby agreed as follows:

SERVICES, RATES AND BILLING: Contractor agrees to provide the services, at the designated rates, as listed in Appendix A to this Agreement.

School District agrees to be billed (except during holidays) by Contractor for up to 40 hours per week for each of Contractor's employees, unless agreed otherwise. No employee of Contractor will work above 40 hours per week without advanced authorization from both Contractor and the designated supervisor assigned by School District. Any hours worked that are considered overtime by state or federal law will be billed at 150% of bill rate. School District will not be billed during school closures and school holidays.

When Statutory Costs and other employee costs of living increase, Contractor will pass those increases along to School District with no mark-up. School District agrees to pay such increases at the same time as any billed fees pursuant to this Agreement. Statutory Costs include any costs and expenses of Contractor that are associated with Workers Comp, FICA, FUTA, SUTA, and incremental costs associated with the Affordable Care Act (ACA), among others.

TRAVEL TIME & MILEAGE: To the extent applicable, travel between schools will be considered billable time and the mileage will be billed at the current IRS mileage rate. No travel will be billed when work is completed at one site.

PAYMENT TERMS: School District will be billed every two weeks via email and agrees to pay all outstanding invoices within 30 days of receipt. School District agrees and understands that School District is billed on actual hours of service provided by the Contractor's employee, based on the total hours listed on a biweekly timesheet. To ensure billing accuracy and timeliness, School District will complete the Billing Details just above the signature section of this Agreement.

A finance charge of 1.5% per month on the unpaid amount of an invoice, or the maximum amount allowed by law, will be charged on past due accounts. Payments by School District will thereafter be applied first to accrued interest and then to the principal unpaid balance. Any attorneys' fees, court costs, or other costs incurred in collection of delinquent accounts shall be paid by School District. If payment of invoices is not current, Contractor may suspend performing further work.



THE STEPPING STONES GROUP
Transforming Lives Together

Corporate Office
123 N Wacker Drive, Suite 1150
Chicago, IL 60606
Ph: 800-337-5965 Fax: 800-822-8287
www.thesteppingstonesgroup.com

REMITTANCE DETAILS: School District will make payments to Contractor at the following address:

PO Box 6280
Carol Stream, IL 60197

If School District prefers to make payments via electronic ACH, instructions can be obtained from the Contractor representative.

EMPLOYEE BENEFITS AND INSURANCE: Contractor will be responsible for providing all employee benefits and insurance including workers' compensation, general liability, and professional liability insurance coverage (with policy limits and deductibles that are appropriate for similarly situated school districts).

NO SOLICITATION: During the term of this Agreement and for a period of two years after the termination of this Agreement, School District agrees not to directly or indirectly contract with, offer employment to or hire any employee of the Contractor assigned to School District or any candidate submitted by Contractor to School District. School District agrees that if School District breaches this no solicitation covenant, direct and indirect damages may be assessed and recovered by Contractor, and Contractor shall be entitled to seek and obtain specific performance.

CONFIDENTIALITY: Except for purposes of implementation and/or enforcement, the Parties agree that this Agreement shall be confidential to the extent allowable by law (As requested by client, approved by S. Palmer on 9/27/21).



COOPERATION: School District agrees to cooperate fully and to provide assistance to Contractor in the investigation and resolution of any complaints, claims, actions, or proceedings that may be brought by or that may involve any employees of Contractor.

TERMINATION: This Agreement will end on July 31, 2023 and may continue beyond this point by mutual consent. School District agrees not to terminate the Agreement until the end of the Term unless (a) Contractor's employee assigned to School District as a whole is deficient in performance of the services hereunder or (b) any employee of Contractor assigned to School District commits an act of professional or ethical misconduct. School District agrees to notify Contractor of any deficiencies in services or possible unethical or unprofessional conduct as soon as School District becomes aware of such deficiencies or misconduct and further agrees to permit Contractor the opportunity to cure any deficiency or misconduct within thirty (30) days of Contractor's receipt of such notice prior to School District delivering notice of termination of this Agreement. Contractor may terminate this Agreement (i) if School District discontinues operations or (ii) if School District fails to make any payments as required by this Agreement.

NONDISCRIMINATION: Contractor represents and warrants that it does not discriminate in hiring and employment practices regarding race, color, religion, disability, sex, age, national origin, ancestry, marital status, pregnancy, or sexual orientation.

INDEMNIFICATION AND LIMITATION OF LIABILITY: To the extent permitted by law, Contractor will defend, indemnify, and hold School District and its equity holders, subsidiaries, directors, officers, agents, representatives, and employees harmless from all claims, losses, and liabilities (including reasonable attorneys' fees) to the extent caused by or arising from Contractor's breach of this Agreement; its failure to discharge its duties and responsibilities under this Agreement; or the gross negligence or willful misconduct of Contractor or Contractor's officers, employees, or authorized agents in the discharge of those duties and responsibilities under this Agreement.

To the extent permitted by law, School District will defend, indemnify, and hold Contractor and its parents, subsidiaries, directors, officers, agents, representatives, and employees harmless from all claims, losses, and liabilities (including reasonable attorneys' fees) to the extent caused by or arising from School District's breach of this Agreement; its failure to discharge its duties and responsibilities under this Agreement; or the gross negligence or willful misconduct of School District or School District's officers, employees, or authorized agents in the discharge of those duties and responsibilities under this Agreement.

Except as expressly set forth herein, neither party shall be liable for or be required to indemnify the other party for any incidental, consequential, exemplary, special, punitive, or lost profit damages that arise in connection with this Agreement, regardless of the form of action (whether in contract, tort, negligence, strict



THE STEPPING STONES GROUP
Transforming Lives Together

Corporate Office
123 N Wacker Drive, Suite 1150
Chicago, IL 60606
Ph: 800-337-5965 Fax: 800-822-8287
www.thesteppingstonesgroup.com

liability, or otherwise) and regardless of how characterized, even if such party has been advised of the possibility of such damages.

As a condition precedent to indemnification, the party seeking indemnification will inform the other party within ten (10) business days after it receives notice of any claim, loss, liability, or demand for which it seeks indemnification from the other party; and the party seeking indemnification will cooperate in the investigation and defense of any such matter.

The provisions in this section of the Agreement constitute the complete agreement between the parties with respect to indemnification, and each party waives its right to assert any common-law indemnification or contribution claim against the other party.

NOTICES: Notices to Contractor shall be sent to:

The Stepping Stones Group
184 High Street, Suite 701
Boston, MA 02110

AND

K12.ops.contracts@thesteppingstonesgroup.com

Notices to School District shall be sent to:

Rio Elementary School District
1800 Solar Drive
Oxnard, CA 93030

JURISDICTION: This agreement shall be governed by, construed, and is enforceable in accordance with the laws of the State of California. Any action or proceeding relating to or arising out of this Agreement shall be commenced and heard in the State or Federal Court sitting in California. Both parties hereby consent to the jurisdiction and venue of such courts.

GENERAL: No provision of this Agreement may be amended or waived unless agreed to in writing and signed by the parties. The provisions of this Agreement will inure to the benefit of and be binding on the parties and their respective representatives, successors, and assigns.



THE STEPPING STONES GROUP
Transforming Lives Together

Corporate Office
123 N Wacker Drive, Suite 1150
Chicago, IL 60606
Ph: 800-337-5965 Fax: 800-822-8287
www.thesteppingstonesgroup.com

BILLING DETAILS FOR SCHOOL DISTRICT:

Billing Contact Name/Title: Heather Pena, Account Clerk

Billing Email/Phone: hpena@rioschools.org

Mailing Address (for invoice): _____

Special Billing Instructions: continue current billing practices

Signed for Contractor:

Signature: *Janine Mahon*

Name: Janine Mahon

Title: Director of Career & Client Services

Date: June, 15, 2022

Signed for School District:

Signature: _____

Name: _____

Title: _____

Date: _____



Appendix A

The services that may be provided under this Agreement and the corresponding hourly bill rates for each service for the are listed below:

Specialty

Hourly Rate

LVN - Rosalie Mactiag

**\$55/hr, 6 hr billable days, expected days 8/23/22 - 6/16/23,
180 days billable**

LVN - Melvie Ursua

**\$55/hr, 6 hr billable days, expected days 8/23/22 - 6/16/23, 180
days billable**

9.26



Agenda Item Details

Meeting	Jun 29, 2022 - RSD Regular Board Meeting
Category	9. Consent
Subject	9.26 Contract with Boys and Girls Club of Greater Oxnard and Port Hueneme for staffing of EXPLORE programs 2022-2023
Access	Public
Type	Action (Consent)
Fiscal Impact	Yes
Dollar Amount	1,329,397.30
Budgeted	Yes
Budget Source	After School Education and Safety (ASES) and Expanded Learning Opportunities Program
Recommended Action	Staff recommends board approval of BGCOP Explore contract for the 2022-2023 school year.

Public Content

Speaker: Oscar Hernandez, Assistant Superintendent Educational Services

Rationale:

BGCOP has historically supported the EXPLORE Program by providing staffing. The EXPLORE Program provides expanded learning opportunities targeting students who are eligible for free or reduced priced meals, English learners, experiencing homelessness, and/or are foster youth. Programs will be available at all schools starting in 2022-2023 through a combination of ASES and ELOP funding.

Signed BGCOP-Rio 22-23 EXPLORE Contract.pdf (849 KB)

Administrative Content

Executive Content

Our adopted rules of Parliamentary Procedure, Robert's Rules, provide for a consent agenda listing several items for approval of the Board by a single motion. Most of the items listed under the consent agenda have gone through Board subcommittee review and recommendation. Documentation concerning these items has been provided to all Board

members and the public in advance to assure an extensive and thorough review. Items may be removed from the consent agenda at the request of any board member.

RIO SERVICES AGREEMENT

Requisition Number _____

Purchase Order Number _____

Contract Number _____

This Services Agreement (the "Agreement") is made and entered into this 29th _____ day of June _____, 2022 _____ by and between Rio School _____ District (hereinafter referred to as "District") and Boys and Girls Club of Greater Oxnard and Port Hueneme _____, (hereinafter referred to as "Provider.")

PROVIDER.

BGCOP _____

Provider

(805) 815-4959 _____

Telephone Number

1900 W. 5th Street _____

Street Address

(805) 815-4709 _____

Fax Number

Oxnard, CA 93030 _____

City, State, Zip code

eantrim@bgcop.org _____

E-mail Address

95-1785162 _____

Tax Identification or Social Security Number

License Number (if applicable)

Type of Business

Individual

Sole Proprietorship

Partnership

Corporation

Other _____

- A. District desires to engage Provider services as more particularly described on "Statement of Work" which is attached hereto and incorporated herein by this reference ("Services").
- B. Provider has the necessary qualifications by reason of training, experience, preparation and organization, and is agreeable to performing and providing such Services, upon and subject to the terms and conditions as set forth below in this Agreement.

NOW THEREFORE, for valuable consideration, the receipt and sufficiency of which are hereby acknowledged, the parties hereto hereby agree as follows:

1. **CONDITIONS.** Provider will have no obligation to provide services until District returns a signed copy of this Agreement.
2. **NATURE OF RELATIONSHIP.** The parties agree the relationship created by this Agreement is that of independent contractor. In performing all of the Services, Provider shall be, and at all times is, acting and performing as an independent contractor with District, and not as a partner, coventurer, agent, or employee of District, and nothing contained herein shall be construed to be inconsistent with this relationship or status. and is not granted any right or authority to assume or to create any obligation or responsibility, express or implied, on behalf of or in the name of District or to bind the District in any manner. Except for any materials, procedures, or subject matter agreed upon between Provider and District, Provider shall have complete control over the manner and method of performing the Services.

Provider understands and agrees to independent contractor status. Provider understands and agrees that the filing and acceptance of this Agreement creates a rebuttable presumption and that the Provider, officers, agents, employees, or subcontractors of Provider are not entitled to coverage under the California Workers' Compensation Insurance laws, Unemployment Insurance, Health Insurance, Pension Plans, or any other benefits normally offered or conveyed to District employees. Provider will be responsible for payment of all Provider employee wages, payroll taxes, employee benefits, and any amounts due for federal and state income taxes and Social Security taxes. These taxes will not be withheld from payments under this agreement.

3. **NON-EXCLUSIVITY.**
 - a. During the term of this agreement Provider may, independent of Provider's relationship with the District, without breaching this Agreement or any duty owed to the District, act in any capacity, and may render services for any other entity.
 - b. During the term of this Agreement the District may, independent of its relationship with the Provider, without breaching this Agreement or any duty owed to the Provider contract with other individuals and entities to render the same or similar services to the District.
4. **SERVICES.** Provider shall provide District with the services, which are described on the "Statement of Work" (the "Work" or "Service") attached hereto and incorporated herein by this reference. The Statement of Work shall contain a timetable for completion of the Work or if the Work is an ongoing service, the Statement of Work shall set forth the mutually agreed schedule for providing such services. Provider shall use its best efforts to complete all phases of the Work according to such timetable. In the event that there is any delay in completion of the Work arising as a result of a problem within the control of

District, Provider and District shall cooperate with each other to work around such delay. However, District shall not be responsible for any additional cost or expense to Provider as a result of such delay unless specifically agreed to in writing by the District. In addition to the specifications and/or requirements contained in the Statement of Work and any warranty given by Provider hereunder, the Statement of Work may set forth those performance criteria agreed between District and Provider whereby the District can evaluate whether Provider has satisfactorily completed the Work ("Performance Criteria").

Provider, at Provider's sole cost and expense, shall furnish all tools, equipment, apparatus, facilities, transportation, labor, and material necessary to meet its obligations under this Agreement. No substitutions of materials or service from those specified in this section shall be made without the prior written consent of the District.

5. **TIME OF PERFORMANCE.** The term of this Agreement shall commence on July 1 _____, 2022__, and terminate on June 30 _____, 2023___. All work and services contracted for under the terms of this Agreement shall be undertaken and completed in such sequence as to assure their full completion in accordance with the terms and conditions set forth in this Agreement.

6. **PAYMENT AND EXPENSES.** All payments due to Provider are set forth in the "Schedule of Fees" attached hereto and incorporated herein by this reference.

Provider shall send District periodic statements indicating Provider's fees and costs incurred and their basis and any current balance owed. If no Provider's fees or costs are incurred for a particular time period, or if they are minimal, the statement may be held by the Provider and combined with that for the following time period unless a statement is requested by the District.

All payments due Provider are set forth in "Schedule of Fees" and shall be paid by the District within 30 days of receipt of a proper invoice from Provider, which invoice shall set forth in reasonable detail the services performed. The District reserves the right, in its sole and absolute discretion, to reject any invoice that is not submitted in compliance with the District's standards and procedures. In the event that any portion of an invoice submitted by a Provider to the District is disputed, the District shall only be required to pay the undisputed portion of such invoice at that time, and the parties shall meet to try to resolve any disputed portion of any invoice.

The rates set forth in "Schedule of Fees" are not set by law, but are negotiable between Provider and District.

7. **ASSIGNMENT AND SUBCONTRACTORS.** Provider shall not assign, sublet, or transfer this Agreement or any rights under or interest in this Agreement without the prior written consent of the District, which may be withheld by the District in its sole and absolute discretion for any reason. Nothing contained herein shall prevent Provider from employing independent associates, subcontractors, and subconsultants as Provider may deem appropriate to assist in the performance of services herein, subject to the prior written

approval of the District. Any attempted assignment, sublease, or transfer in violation of this Agreement shall be null and void, and of no force and affect. Any attempted assignment, sublet, or transfer in violation of this Agreement shall be grounds for the District, in its sole discretion, to terminate the Agreement

8. **TERMINATION OR AMENDMENT.** This Agreement may be terminated or amended in writing at any time by mutual written consent of all of the parties to this Agreement, and may be terminated by either party for any reason by giving the other party 60 days advance written notice. In the event of cancellation prior to completion of the specified services, all finished or unfinished projects, documents, data, studies, and reports prepared by the Provider under this agreement shall, at the option of the District, become District property. The Provider shall be entitled to receive just and equitable compensation for any satisfactory work completed on such items prior to termination of the Agreement.

The parties to this Agreement shall be excused from performance thereunder during the time and to the extent they are prevented from obtaining, delivering, or performing due to act(s) of God. Satisfactory evidence thereof to the other party is required, provided that it is satisfactorily established that the non-performance is not due to the fault or neglect of the party not performing.

9. **NOTICE.** Any notices required or permitted to be given under this Agreement shall be deemed fulfilled by written notice, demand or request personally served on (with proof of service endorsed thereon, or mailed to, or hereinafter provided) the party entitled thereto or on its successors and assigns. If mailed, such notice, demand, or request shall be mailed certified or registered mail, return receipt requested, and deposited in the United States mail addressed to such party at its address set forth below or to such address as either party hereto shall direct by like written notice and shall be deemed to have been made on the third (3rd) day following posting; or if sent by a nationally recognized overnight express carrier, prepaid, such notice shall be deemed to have been made on the next business day following deposit with such carrier. For the purposes herein, notices shall be sent to the District and the Provider as follows:

District

Provider

Attn: _____

Attn: _____

Street

Street

City, State, Zip Code

City, State, Zip Code

10. **WARRANTY.** Provider hereby warrants to District that the Work shall be performed in a professional and workmanlike manner consistent with the highest industry standards. For a period of one (1) year following completion of the Work, Provider shall correct or make

arrangements to correct any breach of the warranty for the Work within ten (10) business days of notice from District of same.

11. **ADDITIONAL WORK.** If changes in the work seem merited by the Provider or the District, and informal consultations with the other party indicate that a change is warranted, it shall be processed by the District in the following manner:

- a. A letter outlining the changes shall be forwarded to the District by the Provider with a statement of estimated changes in fee and/or time schedule.
- b. A written amendment to this Agreement shall be prepared by the District and executed by all of the parties before any performance of such services or the District shall not be required to pay for the increased cost incurred for the changes in the scope of work.

Any such amendment to the Agreement shall not render ineffective or invalidate unaffected portions of this Agreement.

12. **COMPLIANCE WITH LAWS.** Provider hereby agrees that Provider, officers, agents, employees, and subcontractors of Provider shall obey all local, state, and federal laws and regulations in the performance of this Agreement, including, but not limited to minimum wages laws and/or prohibitions against discrimination.

Provider, officers, agents, employees and/or subcontractors of Provider shall secure and maintain in force for the full term of this Agreement, at Provider's sole cost and expense, such licenses and permits as are required by law, in connection with the furnishing of all the Services, materials, or supplies necessary for completion of the Services described.

Provider shall be responsible for all costs of clean up and/or removal of spilled regulated substances as a result of Provider's services or operations performed under this Agreement, including, but not limited to:

- Hazardous and toxic substances,
- Hazardous waste,
- Universal waste,
- Medical waste,
- Biological waste,
- Sharps waste.

13. **PREVAILING WAGE.** Provider shall comply with the California Labor Code regarding the payment of the general prevailing per diem wage rates for public work (construction) projects of more than one thousand dollars (\$1,000).

14. **NON-DISCRIMINATION AND EQUAL EMPLOYMENT OPPORTUNITY**

Provider represents and agrees that it does not and shall not discriminate against any employee or applicant for employment because of race, religion, color, sex, or national origin.

15. **INDEMNIFICATION.** Provider agrees to defend, indemnify, and hold harmless District, its officers, agents, employees, and/or volunteers from any and all claims, demands, losses, damages and expenses, including legal fees and costs, or other obligations or claims arising out of any liability or damage to person or property, or any other loss, sustained or claimed to have been sustained arising out of activities of the Provider or those of any of its officers, agents, employees, or subcontractors of Provider, whether such act or omission is authorized by this Agreement or not. Provider shall also pay for any and all damage to the Real and Personal Property of the District, or loss or theft of such Property, done or caused by such persons. District assumes no responsibility whatsoever for any property placed on District premises by Provider, Provider's agents, employees or subcontractors. Provider further hereby waives any and all rights of subrogation that it may have against the District. The provisions of this Indemnification do not apply to any damage or losses caused solely by the negligence of the District or any of its officers, agents, employees, and/or volunteers.

16. **INSURANCE.** Provider, at its own cost and expense, shall procure and maintain during the term of this Agreement, policies of insurance for the following types of coverage:

Workers' Compensation Insurance. Provider shall procure and maintain, during the term of this Agreement, Workers' Compensation Insurance, as required by California law, on all of its employees engaged in work related to the performance of this Agreement. In the case of any such work which is subcontracted, Provider shall require all subcontractors to provide Workers' Compensation Insurance for all of the subcontractor's employees to be engaged in such work unless such employees are covered by the protection afforded by the Provider's Workers' Compensation Insurance.

Commercial General Liability Insurance. Provider shall procure and maintain, during the term of this Agreement, not less than the following General Liability Insurance coverage:

	Each Occurrence	Aggregate
Individual, Sole Proprietorship, Partnership, Corporation, or Other	\$ 1,000,000.00	\$ 2,000,000.00
High risk events or activities	\$ 2,000,000.00	\$ 4,000,000.00
Severe risk events or activities	\$ 5,000,000.00	\$ 10,000,000.00

Commercial General Liability insurance shall include products/completed operations, broad form property damage, and personal and advertising injury coverage.

Provider's and any and all Provider subcontractor's Commercial General Liability insurance and Abuse and Molestation coverage shall name the District, its employees, and school board members as additional insureds.

Insurance written on a "claims made" basis is to be renewed by the Provider and all Provider subcontractors for a period of five (5) years following termination of this Agreement. Such insurance must have the same coverage and limits as the policy that was in effect during the term of this agreement, and will cover the provider for all claims made.

Failure to Procure Insurance. Failure on the part of Provider, or any of its subcontractors, to procure or maintain required insurance shall constitute a material breach of contract under which the District may immediately terminate this Agreement.

17. **SAFETY AND SECURITY.** Provider shall be responsible for ascertaining from the District all of the rules and regulations pertaining to safety, security, and driving on school grounds, particularly when children are present.

Certain entities that contract with a school district are required to comply with Education Code section 45125.1 regarding fingerprinting requirements unless the district determines that the Provider will have limited contact with students.

Provider and any and all subcontractors are required to comply with Education Code section 45125.1, Fingerprint certification requirements. Provider must provide proof that fingerprint certification requirements have been fulfilled prior to commencing any services for the District under this Agreement.

Provider and its subcontractors are not required to comply with Education Code section 45125.1, Fingerprint certification requirements.

Transportation Providers are required to comply with Education Code section 49406, Examination for Tuberculosis requirements. Provider must cause to be on file with the District a certificate from the examining physician showing the Provider, employees and/or subproviders of Provider have been examined and found free from active tuberculosis.

18. **PROTECTION OF WORK AND PROPERTY.** Provider and all of its subcontractors shall maintain at all times, as required by conditions and progress of work, all necessary safeguards for the protection of employees and the public. In an emergency affecting life and safety of life or work or of adjoining property, Provider is permitted, without special instruction or authorization from the District, to act at its discretion to prevent such threatened loss or injury.

19. **GOVERNING LAW AND VENUES.** Provider hereby acknowledges and agrees that District is a public entity, which is subject to certain requirements and limitations. This Agreement and the obligations of District hereunder are subject to all applicable federal,

state and local laws, rules, and regulations, as currently written or as they may be amended from time to time.

This Agreement shall be interpreted in accordance with the laws of the State of California. If any action is brought to interpret or enforce any term of this Agreement, the action shall be brought in state or federal court situated in the County of Ventura, State of California. Provider hereby waives and expressly agrees not to assert, in any way, any claim or allegation that it is not personally subject to the jurisdiction of the courts named above. Provider further agree to waive any claim or allegation that the suit, action, or proceeding is either brought in an inconvenient forum or that the related venue is improper.”

20. **ARBITRATION.** Any dispute arising under this Agreement, including, without limitation, all disputes relating in any manner to the performance or enforcement of this Agreement shall be resolved by binding arbitration in Ventura County pursuant to the rules of the American Arbitration Association (AAA), as amended or as augmented in this Agreement (the “Rules”). The parties acknowledge that one of the purposes of utilizing arbitration is to avoid lengthy and expensive discovery and allow for prompt resolution of the dispute.

Arbitration shall be initiated as provided by the Rules, although the written notice to the other party initiating arbitration shall also include a description of the claim(s) asserted and the facts upon which the claim(s) are based. Arbitration shall be final and binding upon the parties and shall be the exclusive remedy for all claims subject hereto, including any award of attorneys’ fees and costs. Either party may bring an action in court to compel arbitration under this Agreement and to enforce an arbitration award.

All disputes shall be decided by a single arbitrator. The arbitrator shall be selected by mutual agreement of the parties within 30 days of the effective date of the notice initiating the arbitration. If the parties cannot agree on an arbitrator, then the complaining party shall notify the AAA and request selection of an arbitrator in accordance with the Rules. The arbitrator shall have only such authority to award equitable relief, damages, costs, and fees as a court would have for the particular claim(s) asserted. In no event shall the arbitrator award punitive damages of any kind.

The arbitrator shall have the power to limit or deny a request for documents or a deposition if the arbitrator determines that the request exceeds those matters, which are directly relevant to the claims in controversy. The document demand and response shall conform to Code of Civil Procedure section 2031. The deposition notice shall conform to Code of Civil Procedure section 2025. The parties may make a motion for protective order or motion to compel before the arbitrator with regard to the discovery, as provided in Code of Civil Procedure sections 2025 and 2031.

21. **ATTORNEYS FEES.** In the event of any action or proceeding to interpret or enforce the terms of this Agreement, the prevailing party, as determined by the court or arbitrator, shall

be entitled to recover its reasonable attorneys fees and costs incurred in connection with such actions or proceeding

22. **DOCUMENT RETENTION.** After Provider's services to District conclude, Provider shall, upon the District's request, deliver all documents for all matter in which Provider has provided services to the District, along with any property of the District in Provider's possession and/or control. If the District does not request District's document(s) for a particular service, Provider will retain document(s) for a period of two (2) years after the service has ended. If District does not request delivery of the document(s) for the service before the end of the two (2) year period, Provider will have no further obligation to retain the document(s) and may, at Provider's discretion, destroy it without further notice to the District. At any point during the two (2) year period, District may request delivery of the document(s).

Exceptions: Attorney work-product and medical records shall not be destroyed by provider without the prior written consent of the District.

23. **NATURE OF AGREEMENT.** This Agreement constitutes a binding expression of the understanding of the parties with respect to the services to be provided hereunder and is the sole contract between the parties with respect to the subject matter thereof. There are no collateral understandings or representations or agreements other than those contained herein. This Agreement represents the entire agreement between the parties hereto with respect to the subject matter hereof and supersedes any and all other agreements and communications however characterized, written or oral, between or on behalf of the parties hereto with respect to the subject matter hereof. This Agreement may only be modified by a written instrument signed by authorized representatives of each of the parties hereto.
24. **BINDING EFFECT.** This Agreement shall inure to the benefit and shall be binding upon all of the parties to this Agreement, and their respective successors in interest or assigns.
25. **WAIVER.** No claim or right arising out of a breach of this Agreement can be discharged in whole or in part by a waiver or renunciation of the claim or right unless such waiver is in writing.
26. **SEVERABILITY.** It is intended that each paragraph of this Agreement shall be treated as separate and divisible, and in the event that any paragraphs are deemed unenforceable, the remainder shall continue to be in full force and effect so long as the primary purpose of this Agreement is unaffected.
27. **PARAGRAPH HEADINGS.** The headings of paragraphs hereof are inserted only for the purpose of convenient reference. Such headings shall not be deemed to govern, limit, modify or in any other manner affect the scope, meaning or intent of the provisions of this Agreement or any part or portion thereof, nor shall they otherwise be given any legal effect whatsoever.

28. **AUTHORITY.** Provider represents and warrants that Provider has all requisite power and authority to conduct its business and to execute, deliver, and perform this Agreement. Each party warrants that the individuals who have signed this Agreement have the legal power, right, and authority to make this Agreement and to bind each respective party.
29. **COUNTERPART EXECUTION: ELECTRONIC DELIVERY.** This Agreement may be executed in any number of counterparts which, when taken together, shall constitute one and the same instrument. Executed counterparts of this Agreement may be delivered by PDF email or electronic facsimile transmission, and shall have the same legal effect as an "ink-signed" original.

IN WITNESS WHEREOF, the parties have executed this agreement as of the date first written above.

By: _____ Signature	Rio School District _____ District	BGCOP _____ Provider	 _____ Signature
_____ Name	John Puglisi, Ph.D. _____ Name	Erin Antrim _____ Name	_____ Signature
_____ Title	Superintendent _____ Title	CEO _____ Title	_____ Title

Approved as to form:

 Signature

 Name
 District Counsel

STATEMENT OF WORK

DESCRIPTION OF WORK:

Provider will hire and supervise EXPLORE program staff for the following programs and locations:

2022-2023 EXPLORE Program staffing (57 staff)

Rio del Mar
Rio del Norte
Rio del Sol
Rio del Valle
Rio Lindo
Rio Plaza
Rio Real
Rio Rosales
Rio Vista

2023 EXPLORE Spring Program (10 staff)

Locations TBD

2022-2023 EXPLORE Saturday Program (5 staff)

Locations TBD

Provider and the District shall collaboratively appoint and employ staff members at each Program Location (hereinafter “Professional Staff”). District site coordinators and Provider director will interview and approve all Professional Staff hires. The Program Administrator shall specifically ensure, in part, that all Professional Staff who directly supervise pupils meet the minimum qualifications to serve as an Instructional Aide in the District. The District human resources department will administer the “Instructional Assistant Examination” for the expanded learning program staff hiring pool and will provide verification to Provider for their hiring process.

BGCOP shall serve as the sole employer of all Provider employees required to staff the Program, and shall exercise authority to supervise and evaluate its employees, except as expressly provided herein.

Professional staff for each Program Location shall provide the following direct EXPLORE Program services:

- Develop daily lesson plans and weekly schedules for program
- Lead classes of no more than 20 students

- Supervise students
- Record daily attendance
- Attend all District-provided professional development opportunities

WORK SCHEDULE:

2022-23 EXPLORE Program

After School Program Director (ASPD): 1 FT \$60,000 per year = \$60,000

After School Program Leads (ASPC): 9 x \$21 per hour x 5 hours per day (1pm-6pm) x 180 days = \$170,100

24 x \$19.00 per hour x 4 (2-6) hours per day x 143 days = \$260,832 + 24 x \$19 per hour x 6 (12-6) hours for early release 37 days = \$101,232 = \$362,064 (\$260,832 + \$101,232)

24 x \$18.00 per hour x 4 (2-6) hours per day x 143 days = \$247,104 + 24 x \$18 per hour x 6 (12-6) hours for early release 37 days = \$95,904 = \$343,008 (\$247,104 + \$95,904)

After School Programs Specialist: \$37,440 per year x 0.091 PTE = \$3,407

Saturday and Spring - 30 Non-School Days - ELOP

Youth Development Specialists (YDS): 5 x \$19 per hour x 5 hours per day x 20 days for Rio Plaza Saturdays = \$9,500

Youth Development Specialists (YDS): 5 x \$18 per hour x 5 hours per day (11-5:30pm) x 5 days for Rio Vista Spring Program 4/10/23-4/14/23 = \$9,000

Youth Development Specialists (YDS): 5 x \$18 per hour x 5 hours per day (11-5:30pm) x 5 days for Rio Plaza Spring Program 4/10/23-4/14/23 = \$2,250

Professional Development 15 hours of training for 57 staff

SCHEDULE OF FEES

FEES:

Compensation for Services	\$ _____
Actual and Necessary Travel Expenses	\$ _____
Other Expenses	\$ _____
Total Amount not to Exceed	<u>\$1,329,397.30</u>
Deposit	\$ _____
Balance Due after Completion of Services	\$ _____

Proper invoicing is required. Receipts for expenses are required. Canceled checks are not accepted as receipts.

PAYMENT SCHEDULE:

ADDITIONAL COSTS OF EXPENSES:

9.27



Agenda Item Details

Meeting	Jun 29, 2022 - RSD Regular Board Meeting
Category	9. Consent
Subject	9.27 Approval of Center for Effective Philanthropy, Inc. (CEP) Contract
Access	Public
Type	Action (Consent)
Fiscal Impact	Yes
Dollar Amount	33,500.00
Budgeted	Yes
Budget Source	LCAP Funds
Recommended Action	Staff recommends board approval of the Center for Effective Philanthropy, Inc.

Public Content

Speaker: Oscar Hernandez, Assistant Superintendent Educational Services

Rationale:

Rio School District surveys district staff, students and parents at each school through YouthTruth since 2019. We would like to renew the current agreement with the Center for Effective Philanthropy, Inc. but instead of an annual agreement, we would like the governing board to approve a 3-year agreement from 2022 - 2025 in the amount of \$33,500.

Research shows that student perceptions are empirically linked to academic outcomes. YouthTruth allows educators to hear directly from students about how they are experiencing school. YouthTruth data can be used for strategic planning, DEI initiatives, monitoring how big changes, like new curriculum, technology, or learning models are affecting students, and for professional development.

[Rio STEP 1 - YouthTruth Client Agreement and Registration Form 2022-2023 \(1\).pdf \(2,783 KB\)](#)

Administrative Content

Executive Content

Our adopted rules of Parliamentary Procedure, Robert's Rules, provide for a consent agenda listing several items for approval of the Board by a single motion. Most of the items listed under the consent agenda have gone through Board subcommittee review and recommendation. Documentation concerning these items has been provided to all Board members and the public in advance to assure an extensive and thorough review. Items may be removed from the consent agenda at the request of any board member.

YouthTruth

STUDENT SURVEY

A NATIONAL NONPROFIT

Client Agreement & Registration Form

2022-23, 2023-24, 2024-25

This agreement between the YouthTruth, a project of the Center for Effective Philanthropy, Inc., ("CEP") and the client organization ("Client") confirms your participation and agreement to the below terms.

Contact Information

Organization Name: **Rio School District**

Main Contact Name:

Main Contact Phone:

Main Contact Title:

Main Contact Email:

Billing Contact:

Billing Contact Phone:

Billing Contact Email:

Billing Address:

Payment & Timing

Total Annual Cost (to be completed by YouthTruth): **\$33,500**

3-Year Package: Yes No Notes:

Select annual survey window:

- October November December January
 February March April May
 June or other custom window (additional fee):

Products & Services

1. Choose survey type and enter number of schools

Student Survey High School(s) **5** Middle School(s) **8** Elementary School(s) (3rd grade up)

2. Add other stakeholder surveys and enter number of schools

Staff Survey High School(s) **2** Middle School(s) **7** Elementary School(s)

Family Survey High School(s) **2** Middle School(s) **7** Elementary School(s)

3. Add Advisory Services Selected Advisory Services and notes*:

1 in-person workshop

Special Customization (to be completed by YouthTruth) Custom Questions Custom Analysis Data Files

Scan and email your completed form to hello@youthtruthsurvey.org or fax to (415) 358-4947

Questions? Contact us toll free (415) 286-9538 or at hello@youthtruthsurvey.org

Parental Consent

Under applicable federal, state, and local laws, the client may be required to collect informed parental consent for students to participate. CEP presumptively assumes that this consent has been collected, if necessary, by the time of survey administration. YouthTruth has provided a sample parental consent letter (available to download at youthtruthsurvey.org/parentalnotification) that clients are welcome to edit for their own purposes.

Confidentiality

CEP will not reveal any survey data about, nor attribute any data to, the client's district/network or school(s) in any publication other than the YouthTruth reports provided to the client without the client's expressed permission. CEP will not report findings for subgroups comprised of less than five students in any YouthTruth reports, and will use all commercially reasonable efforts to protect the confidentiality of all individual student responses in YouthTruth reports and in any future research. CEP has a process in place to flag and communicate concerning comments to the client, and may disclose otherwise confidential responses where the responses contain allegations of abuse or explicit threats of harm to the student or others. CEP may cite your district/network and school(s) as YouthTruth Survey participants in its marketing materials, on its web site, and elsewhere.

Data Use by Clients

The client may use the YouthTruth findings in communications with internal and external audiences, make available representative portions of your YouthTruth report, quote from your report, or otherwise disclose your results. In doing so, the client agrees to cite CEP as having collected the data, produced the report, and maintained the confidentiality of individual respondents. The client is solely responsible for its use of the YouthTruth survey results, and any effects of such use. The client agrees that it has the right to provide staff contact information for CEP's use in administering the survey.

Data Use by YouthTruth

Subject to the rights of the client, students, and parents in survey data that comprise education records, CEP shall own all data collected or generated from the survey, all rights to the techniques and methodologies used to produce YouthTruth reports, and the copyright to all YouthTruth reports. CEP and its research partners may use the client's survey data in comparative datasets for products we may produce in future years or in research reports. CEP reserves the right to test a limited number of questions in our surveys.

Invoicing

The billing contact will be invoiced 30 days prior to the first date of the survey window, with payment due in full within 30 days, unless otherwise agreed upon. Invoices will be generated from and payment must be made to the Center for Effective Philanthropy.

X 

Jen Vorse Wilka
Executive Director, YouthTruth

Date: 05/27/2022

Early Termination and Late Rescheduling

The Client may terminate this agreement prior to 90 days before the first day of the scheduled survey window at no cost. If the Client elects to terminate all or a portion of the scope of work in this agreement or change the survey window between 30 and 90 calendar days prior to the first day of the survey window each year, a fee of one-third of the total annual cost will be invoiced and due in full within 30 days. If the Client fails to complete required survey preparation forms by the specified deadline (typically between 50 and 65 days prior to the first day of the survey window), the Client forfeits their survey window spot and will be invoiced a fee of one-third the total annual cost, due in full within 30 days to reimburse CEP for costs invested to date. If the Client elects to terminate this agreement or change the survey window less than 30 days prior to the first day of the survey window each year, the full annual cost invoiced will be due in full within 30 days to account for upfront costs invested by the CEP.

Legal Obligation

CEP is obligated to respond to a properly issued and served subpoena or other legal process, including reporting allegations of abuse or neglect as cited in student comments, according to the laws governing the client's state. Unless CEP is not permitted by law to disclose the fact or content of the subpoena or legal process, CEP will provide the client with timely notice of any such proceedings. Furthermore, it is assumed that the client will inform CEP of all relevant client policies and laws related to administering the survey and analyzing and reporting survey data.

Modification and Liability

No waiver, modification or amendment of this letter of agreement shall be binding upon either party unless confirmed by a written instrument signed by both parties. This letter of agreement shall be governed by the laws of the Commonwealth of Massachusetts excluding its choice of law provisions. Each party submits to the exclusive jurisdiction of the state and federal courts sitting in the Commonwealth of Massachusetts in any action or proceeding arising out of or relating to this letter of agreement and waives any claim of inconvenient forum or other challenge to venue in any such court. If any portion of any provision of this letter of agreement is held invalid or unenforceable for any reason, the remainder of the provision shall be amended to achieve as closely as possible the original purpose of the provision and all other provisions shall continue in full force and effect. The client agrees that any liability that may arise under this agreement shall be limited in the aggregate to the amount actually paid to CEP for the services described in this agreement. CEP provides no express warranty with respect to such services and disclaims all implied warranties (including the warranties of merchantability and fitness for a particular purpose) to the fullest extent permitted by law.

Advisory Services

Client agrees to complete all advisory services within 90 calendar days of survey close.

X _____

Name:

Title:

Date:

Please submit school information and contacts via the STEP 2 REGISTRATION FORM available at youthtruthsurvey.org/get-started

Scan and email your completed form to hello@youthtruthsurvey.org or fax to (415) 358-4947

Questions? Contact us toll free (415) 286-9538 or at hello@youthtruthsurvey.org

9.28



Agenda Item Details

Meeting	Jun 29, 2022 - RSD Regular Board Meeting
Category	9. Consent
Subject	9.28 Approval to Contract Renewal with Securly for Content Filtering System
Access	Public
Type	Action (Consent)
Preferred Date	Jun 29, 2022
Absolute Date	Jul 01, 2022
Fiscal Impact	Yes
Dollar Amount	35,500.00
Budgeted	Yes
Budget Source	LCAP
Recommended Action	Staff recommends approval of renewing the web filtering contract with Securly.

Public Content

Speaker: Jarkko Myllari

Rationale: To ensure uninterrupted filtering and safety of the network traffic in the district, staff recommends renewing the contract with Securly, that provides a cost effective, cloud based filtering and device monitoring solution.

Rio School District Securly Proposal 6-2-2022.pdf (163 KB)

Administrative Content

Executive Content

Our adopted rules of Parliamentary Procedure, Robert's Rules, provide for a consent agenda listing several items for approval of the Board by a single motion. Most of the items listed under the consent agenda have gone through Board subcommittee review and recommendation. Documentation concerning these items has been provided to all Board

members and the public in advance to assure an extensive and thorough review. Items may be removed from the consent agenda at the request of any board member.



June 2, 2022

Billed to:

Trebron Security, LLC
P.O. Box 68
Strasburg, PA 17579
Attn: Phil Santoro: 610-401-8841
psantoro@trebron.com

Rio School District
1800 Solar Drive
Oxnard, CA 93030
Attn: Jarkko Myllari 805-485-3111 ext. 6623
jmyllari@rioschools.org

Table with 3 columns: Quote Number (06022022-PS), Quote Valid Until (7-1-2022), Payment Terms (Special Trebron Payment Plan / Net 30)

1-Year Option

Table with 4 columns: Qty (Users), Included Components, Term (Months), Total Price (\$USD). Rows for Security Filter Premium and Security Classroom Premium, with a total of \$35,500.00.

Special Trebron Payment Plan

Payment due July 31, 2022 \$35,500.00

3-Year Option

Table with 4 columns: Qty (Users), Included Components, Term (Months), Total Price (\$USD). Rows for Security Filter Premium and Security Classroom Premium, with a total of \$98,750.00.

Special Trebron Payment Plan

Payment due July 31, 2022 \$32,916.66
Payment due July 31, 2023 \$32,916.67
Payment due July 31, 2024 \$32,916.67

Notes:

- Licenses - granted pursuant to the terms of the Securly End User License Agreement (EULA)

Order Confirmation: Please sign and fax to (206-527-4288) or email to your Trebron Account Executive.

I understand that by signing this Purchase Order/Quote confirmation I agree to the following:

- I am authorized by the "billed to" party to purchase the item listed above.
All information is accurate with regard to price, description, quantity and billing address.
The "billed to" party agrees to pay the invoice in accordance with terms of Net 30.
Late Charges will be billed after 30 days at 18% rate of interest including, but not limited to legal fees to collect.
Product licenses provide rights to utilize the aforementioned software to a maximum of the quoted quantity.
This quote shall in no way be construed as creating an obligation on the part of Securly, but rather indicates a right and intent to enter into an agreement with the "billed to" party described above.
To take advantage of the Trebron Payment Plan a "Trebron Purchase Agreement" will also need to be signed.

Tax Exempt? Yes No (if yes, please supply tax exempt number or documentation showing tax exempt status)

Authorized Signature: _____

Date: _____

Print name: _____

Title: _____

Purchase Order #: _____

9.29



Agenda Item Details

Meeting	Jun 29, 2022 - RSD Regular Board Meeting
Category	9. Consent
Subject	9.29 Contract with MICOP for Mixteco translation and outreach services 2022-2023 school
Access	Public
Type	Action (Consent)
Fiscal Impact	Yes
Dollar Amount	169,497.00
Budgeted	Yes
Budget Source	LCAP Funds
Recommended Action	Staff recommends board approval of the 2022-2023 MICOP contract.

Public Content

Speaker: Oscar Hernandez, Assistant Superintendent Educational Services

Rationale:

The Mixteco Indigena Community Organizing Project (MICOP) has continued to provide the Rio School District with translation and outreach services to the Mixteco community.

These services include but are not limited to translation services for IEPs, translation of community information meetings, broadcasting district information via Mixtec language radio, assisting families with registration and form completion, technology assistance, home visits, in-class student support, etc.

The 2.0 full time equivalents served the district's 145 Mixtec-speaking students and their families throughout the pandemic, working weekly in person to support families needs and answer questions in addition to regular outreach translation services.

MICOP 2022-2023 Contract.pdf (2,784 KB)

Administrative Content

Executive Content

Our adopted rules of Parliamentary Procedure, Robert's Rules, provide for a consent agenda listing several items for approval of the Board by a single motion. Most of the items listed under the consent agenda have gone through Board subcommittee review and recommendation. Documentation concerning these items has been provided to all Board members and the public in advance to assure an extensive and thorough review. Items may be removed from the consent agenda at the request of any board member.

AGREEMENT FOR CONTRACTOR/INDEPENDENT CONTRACTOR SERVICES

THIS AGREEMENT, made and entered into this day of June 29, 2022, by and between the **RIO SCHOOL DISTRICT, 1800 Solar Drive., OXNARD, CA 93030**, hereinafter referred to as the DISTRICT and **MIXTECO/INDIGENA COMMUNITY ORGANIZING PROJECT**, hereinafter referred to as the CONTRACTOR.

WITNESSTH:

WHEREAS, the District is authorized by California Government Code, Section 53060 to contract with an independent contractor for the furnishing to the District special services to enhance curriculum in addition to and advice in financial, economic, legal, or administrative matters, if said contractor is specifically trained, experienced, and competent to render the special Contractor services set forth in this Agreement; and

WHEREAS, the District has determined that it is necessary that the services set forth herein be provided, and that such services will assist the governing board providing an enhanced instructional program and in discharging its legal obligations will supplement assistance by State and County authorities and not replace such assistance; and

WHEREAS, the Contractor has offered to provide to the District such special services;

NOW, THEREFORE, in consideration of their mutual promises, the parties hereto agree to enter into a fixed price contract, as follows:

- 1. SCOPE OF WORK.** The contractor will hire and assign 2.0 full time equivalents to provide Mixteco translation services, outreach and resource and referral to the Mixteco community, conduct parent/family education workshops, partner in community meetings and collaborate with District staff and programs including services related to the Educational Services Department.
- 2. COMPENSATION AND TERM.** In consideration of the service to be rendered by the Contractor, the District agrees to pay at the rate of **\$43.96** per hour for full-time Promotor(a), not to exceed **\$169,497.00** beginning on July 1, 2022 and ending on June 30, 2023. These dates may be changed by an amendment to this agreement signed by both parties.
- 3. INDEPENDENT CONTRACTOR.** While engaged in carrying out and complying with the terms of this Agreement, Contractor is an independent contractor and not an officer, agent, or employee of the District. The parties agree and understand that the Contractor is an independent contractor and not the agent or employee of the District and that no liability shall attach to the District by reason of entering into this Agreement.

4. INSURANCE. (If the contractor is a public school agency within Ventura County, participating in the VCSSFA liability program, this insurance section does not apply.) Contractor shall, at Contractor's sole cost and expense, provide for and maintain in force and effect, a policy or policies of insurance covering Contractor's services, including Comprehensive general liability and property damage insurance and comprehensive automobile liability insurance covering activities and operations of the Contractor.

The Contractor agrees to provide workers compensation insurance covering services to be provided by Contractor under this agreement, or to self-insure such services, and to provide a Certificate of Insurance to the District as proof of coverage **if requested**.

5. INDEMNIFICATION/HOLD HARMLESS. Contractor also agrees to hold harmless and indemnify the District, its officers, agents employees, and volunteers from any and all loss, costs, and expense, including legal fees, or other obligations or claims, arising out of any liability or claim of liability for personal injury, bodily injury to persons, contractual liability or damage to property or any other loss, sustained or claimed to have been sustained arising out of activities of the Contractor or those of any of its officers, agents or employees, whether such act is authorized by this Agreement or not; and Contractor shall pay for any and all damage to the property of the District, or loss or theft of such property, done or caused by such persons. District assumes no responsibility whatsoever for any property placed on the premises. Contractor further agrees to waive all right of subrogation against the District.

6. SUBCONTRACTING. None of the services covered by this contract shall be subcontracted without the prior written consent of the District. The Contractor shall be as fully responsible to the District for the acts and omissions of his subcontracts, and of person either directly or indirectly employed by him/her, as if the acts and omissions were performed by him/her directly.

7. COPYRIGHT. Contract hereby agrees that the District shall be the sole owner of the copyright for any publications, writing, materials or product developed by or as a result of this Agreement. Contractor shall maintain the confidentiality of any such material produced.

8. ASSIGNMENT. The parties agree that this Agreement may not be assigned in whole or in part, or any of its rights, obligations provisions, or conditions without the written consent of the District.

9. COMPLIANCE WITH FINGERPRINT LAWS. Certain entities that contract with a school district are required to comply with Education Code section 45125.1 regarding fingerprinting requirements unless the district determines that the contracting entity will have limited contact with pupils.

_____ Contractor need not comply with fingerprint certification requirement.

X Contractor is required to comply with fingerprint certification. (See Appendix A)

IN WITNESSETH WHEREOF, the parties hereto have set their hands on the day and year first above written.

RIO SCHOOL DISTRICT

Principal/Department Head Date

Assistant Superintendent for Business Services Date

Superintendent or designee Date

CONTRACTOR



Authorized Signature Date

Arcenio Lopez, Executive Director
Mixteco/Indigena Community Organizing Project
520 West 5th St.
Oxnard CA 93030

30-0045901
Tax ID # (required W-9 attachment)

PO Box 20543, Oxnard, CA 93034
Address

805-247-1188
Phone Fax #

arcenio.lopez@mixteco.org
e-mail address

APPENDIX A – CERTIFICATION OF FINGERPRINTING

TO THE GOVERNING BOARD OF RIO SCHOOL DISTRICT AND THE DISTRICT ADMINISTRATORS IN CHARGE OF THIS AGREEMENT.

I. Identification of the Parties:

I, Arcenio Lopez, am an individual contractor, consultant. My entity is seeking to contract with the Rio Elementary School District to provide Mixteco translation services, outreach and resource and referral to the Mixteco community to the District, and I am aware of the requirements of Education Code section 45125.1.

II. Certifications

I make the following certifications under penalty of perjury:

A. I shall not begin to provide services to the District nor Shall I permit any of my employees or independent contractors to come in contact with pupils until the Department of Justice has ascertained that the person has not been convicted of a serious or violent felony as defined in Penal Code section 1192.7© and 667.5. (Education Code section 45125.1(e).)

B. I certify that I have reviewed the results of the fingerprinting information ascertained by the Department of Justice, and I certify that none of my employees or independent contractors, including myself, who may come in contact with pupils have been convicted of a felony as noted in paragraph A above. (Education Code section 45125.1(e).

C. I have attached to this certification form a list of the names of my employees or independent contractors who may come in contact with pupil. (Education Code section 45125.1 (f).)

I declare under penalty of perjury under the laws of the State of California that the information provided above is true and correct.

Dated: June 17, 2022 at Ormond (City) California.

Signature

**Request for Taxpayer
Identification Number and Certification**

Give Form to the requester. Do not send to the IRS.

1 Name (as shown on your income tax return). Name is required on this line; do not leave this line blank.
Mixteco/Indigena Community Organizing Project

2 Business name/disregarded entity name, if different from above

3 Check appropriate box for federal tax classification; check only one of the following seven boxes:
 Individual/sole proprietor or single-member LLC
 C Corporation
 S Corporation
 Partnership
 Trust/estate
 Limited liability company. Enter the tax classification (C=C corporation, S=S corporation, P=partnership) ▶ _____
 Note. For a single-member LLC that is disregarded, do not check LLC; check the appropriate box in the line above for the tax classification of the single-member owner.
 Other (see instructions) ▶ _____

4 Exemptions (codes apply only to certain entities, not individuals; see instructions on page 3):
 Exempt payee code (if any) _____
 Exemption from FATCA reporting code (if any) _____
 (Applies to accounts maintained outside the U.S.)

5 Address (number, street, and apt. or suite no.)
200 West 5th St

6 City, state, and ZIP code
Oxnard, CA 93030

7 List account number(s) here (optional)

Requester's name and address (optional)

Part I Taxpayer Identification Number (TIN)

Enter your TIN in the appropriate box. The TIN provided must match the name given on line 1 to avoid backup withholding. For individuals, this is generally your social security number (SSN). However, for a resident alien, sole proprietor, or disregarded entity, see the Part I Instructions on page 3. For other entities, it is your employer identification number (EIN). If you do not have a number, see *How to get a TIN* on page 3.

Note. If the account is in more than one name, see the instructions for line 1 and the chart on page 4 for guidelines on whose number to enter.

Social security number

			-			-			
--	--	--	---	--	--	---	--	--	--

 OR
 Employer identification number

3	0	-	0	0	4	5	9	0	1
---	---	---	---	---	---	---	---	---	---

Part II Certification

Under penalties of perjury, I certify that:

- The number shown on this form is my correct taxpayer identification number (or I am waiting for a number to be issued to me); and
- I am not subject to backup withholding because: (a) I am exempt from backup withholding, or (b) I have not been notified by the Internal Revenue Service (IRS) that I am subject to backup withholding as a result of a failure to report all interest or dividends, or (c) the IRS has notified me that I am no longer subject to backup withholding; and
- I am a U.S. citizen or other U.S. person (defined below); and
- The FATCA code(s) entered on this form (if any) indicating that I am exempt from FATCA reporting is correct.

Certification Instructions. You must cross out item 2 above if you have been notified by the IRS that you are currently subject to backup withholding because you have failed to report all interest and dividends on your tax return. For real estate transactions, item 2 does not apply. For mortgage interest paid, acquisition or abandonment of secured property, cancellation of debt, contributions to an individual retirement arrangement (IRA), and generally, payments other than interest and dividends, you are not required to sign the certification, but you must provide your correct TIN. See the instructions on page 3.

Sign Here
 Signature of U.S. person ▶ Donna Goetz
 Date ▶ 1/10/2022

General Instructions

Section references are to the Internal Revenue Code unless otherwise noted.

Future developments. Information about developments affecting Form W-9 (such as legislation enacted after we release it) is at www.irs.gov/ir9.

Purpose of Form

An individual or entity (Form W-9 requester) who is required to file an information return with the IRS must obtain your correct taxpayer identification number (TIN) which may be your social security number (SSN), individual taxpayer identification number (ITIN), adoption taxpayer identification number (ATIN), or employer identification number (EIN), to report on an information return the amount paid to you, or other amount reportable on an information return. Examples of information returns include, but are not limited to, the following:

- Form 1099-INT (interest earned or paid)
- Form 1099-DIV (dividends, including those from stocks or mutual funds)
- Form 1099-MISC (various types of income, prizes, awards, or gross proceeds)
- Form 1099-B (stock or mutual fund sales and certain other transactions by brokers)
- Form 1099-S (proceeds from real estate transactions)
- Form 1099-K (merchant card and third party network transactions)

- Form 1098 (home mortgage interest), 1098-E (student loan interest), 1098-T (tuition)
- Form 1099-C (canceled debt)
- Form 1099-A (acquisition or abandonment of secured property)

Use Form W-9 only if you are a U.S. person (including a resident alien), to provide your correct TIN.

If you do not return Form W-9 to the requester with a TIN, you might be subject to backup withholding. See *What is backup withholding?* on page 2.

By signing the filled-out form, you:

- Certify that the TIN you are giving is correct (or you are waiting for a number to be issued).
- Certify that you are not subject to backup withholding, or
- Claim exemption from backup withholding if you are a U.S. exempt payee. If applicable, you are also certifying that as a U.S. person, your allocable share of any partnership income from a U.S. trade or business is not subject to the withholding tax on foreign partners' share of effectively connected income, and
- Certify that FATCA code(s) entered on this form (if any) indicating that you are exempt from the FATCA reporting, is correct. See *What is FATCA reporting?* on page 2 for further information.

9.30



Agenda Item Details

Meeting	Jun 29, 2022 - RSD Regular Board Meeting
Category	9. Consent
Subject	9.30 Approval of Open Up Resource Workbook purchase for 2022-2023 School Year
Access	Public
Type	Action (Consent)
Fiscal Impact	Yes
Dollar Amount	40,594.00
Budgeted	Yes
Budget Source	LCAP Funds
Recommended Action	Staff recommends board approval of Open Up Resource workbooks for 6-8 grade teachers at Rio del Valle and Rio Vista.

Public Content

Speaker: Oscar Hernandez, Assistant Superintendent Educational Services

Rationale:

Open Up Resources (OUR) is one of the [highest rated](#) curriculum. It has advanced support for English Learners. It's open source, so it's free. Teachers may sign up to get access to all the materials. And that's how our teachers have been using OUR, but the printing of student practice sheets is straining and not cost effective at all.

Our district adopted Connected Mathematics Project 3 (CMP3). Unfortunately, this curriculum [did NOT meet expectations](#).

We are asking for board approval to purchase these workbooks for two middle schools: Rio del Valle and Rio Vista. They have been using these as their primary curriculum.

Three years ago, several teachers were already using OUR. So I came along and amplified my approval of OUR (and used it as a classroom teacher myself). I shared the edreports ratings below with the teachers.

 image.png

Administrative Content

Executive Content

Our adopted rules of Parliamentary Procedure, Robert's Rules, provide for a consent agenda listing several items for approval of the Board by a single motion. Most of the items listed under the consent agenda have gone through Board subcommittee review and recommendation. Documentation concerning these items has been provided to all Board members and the public in advance to assure an extensive and thorough review. Items may be removed from the consent agenda at the request of any board member.

9.31



Agenda Item Details

Meeting	Jun 29, 2022 - RSD Regular Board Meeting
Category	9. Consent
Subject	9.31 Approval of the Annual Q SIS Hosting Service Level Agreement
Access	Public
Type	Action (Consent)
Preferred Date	Jun 29, 2022
Absolute Date	Jun 29, 2022
Fiscal Impact	Yes
Dollar Amount	80,031.00
Budgeted	Yes
Budget Source	LCAP
Recommended Action	Staff recommends renewing the Annual Q SIS Hosting Service Level Agreement

Public Content

Speaker: Jarkko Myllari

Rationale: Rio is one of the school districts in Ventura County which uses the Q student information system. The Ventura County Office of Education hosts the software, provides training and updates, and offers support to local school district staff that use the software. Rio has been using Q software for more than 12 years.

Rio SD 22-23.pdf (561 KB)

Administrative Content

Executive Content

Our adopted rules of Parliamentary Procedure, Robert's Rules, provide for a consent agenda listing several items for approval of the Board by a single motion. Most of the items listed under the consent agenda have gone through Board subcommittee review and recommendation. Documentation concerning these items has been provided to all Board

members and the public in advance to assure an extensive and thorough review. Items may be removed from the consent agenda at the request of any board member.

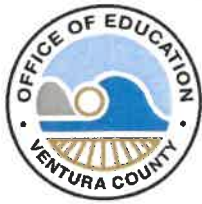

Annual Q SIS Hosting Service Level Agreement

This document identifies the terms of the Annual Q Hosting Service Level Agreement. This Service Level Agreement is for the period beginning July 1, 2022 and ending June 30, 2023.

LEA: Rio School District

Service	Total Cost
SIS	\$ 27,337
Food Service	\$ 6,363
Q Communication (ParentSquare)	\$ 26,065
Hosting Fee	\$ 20,267
Total Invoice	\$ 80,031

VCOE Annual Q Hosting Service Level Agreement includes the following:

1. Point of contact calls and e-mails to VCOE Service Center

- The LEA will designate a **point person(s)** to communicate with VCOE Service Center and in turn relay information to their respective staff.
- VCOE Service Center is open between the hours of 8:00 a.m. and 5:00 p.m. M-F.
- A reasonable expectation for response time, either by phone or e-mail, is 2 hours.
- A timely resolution to the service request depends on the nature of the problem. *LEA determined **Emergency Requests** will be billed at prevailing VCOE rates.*

2. VCOE makes all reasonable efforts to assure security and integrity of the Q server(s) including:

- All server infrastructure regularly patched and monitored
- Database backups performed nightly
- Database administration and monitoring
- Servers are located behind VCOE firewall
- VCOE data center has secure key access
- VCOE data center has filtered UPS power and a diesel generator
- VCOE assures that servers have up to date SSL certificates

3. Review and deploy software enhancements and hot fixes

- All Q software releases will be reviewed prior to deployment by VCOE staff.
- Reasonable efforts will be made to schedule deployment so as not to negatively impact LEA

4. Confidentiality. From time to time, VCOE and/or VCOE's staff shall have access to confidential documents of the client such as tentative agreements, potential bargaining terms, employee social

Ventura County Office of Education, Technology Services

security data, etc. (collectively "Confidential Information"). It is not the intent of the Parties to waive any confidentiality rights that pertain to any document or personal information not otherwise disclosable under the California Public Records Act (Government Code §§ 6250, et. seq.), including but not limited to, confidential personnel matters, educational records as defined under the Family Educational Rights and Privacy Act ("FERPA") (34 C.F.R. § 99.3), social security numbers (Cal. Civ. Code §§ 1798.85-1798.86.), and any other personal information or records protected from disclosure by any other laws pertaining to privacy and confidentiality, as well as under the attorney-client privilege, the attorney work-product doctrine, and all other applicable privileges and protections. VCOE agrees to ensure the handling of such information so as not to compromise the confidential nature of the data. VCOE shall use the Confidential Information solely in connection with the performance by VCOE of the Services provided to the Client and shall not use the Confidential Information for any other purpose. VCOE shall not disclose, distribute, or disseminate any Confidential Information to any other person or entity. VCOE shall hold the Confidential Information in trust for the Client's benefit and shall utilize the utmost care at all times to adopt and follow practices and procedures to prevent the unauthorized disclosure of any Confidential Information. If Confidential Information in the possession of VCOE is accessed without authorization, or if a system maintained by the VCOE containing Confidential Information is breached, VCOE shall notify the Client in writing without delay.

5. Hosting services include:

- SQL Administration and management including the creation and maintenance of*:
 - Stored Procedures
 - Execution hooks
 - Views

*VCOE is not responsible for errors and omissions of data entered by LEA staff. It is the responsibility of the LEA to assure that integrity of data is maintained.

6. VCOE requires the LEA to do the following:

- Institute a password change policy of no greater than 90 days
- Require all users to sign an "acceptance of responsibility form" that they understand the criticality of account name/password security. An "acceptance of responsibility form" includes:

*Account names and passwords should **never** be written out and available to others.*

7. LEA's responsibilities include the following:

- Maintain account creation, deletion, password change, and general maintenance of accounts
- Point of contact person responsible for communicating to LEA staff information regarding software releases, hot fixes, and system availability
- Provide in house user training and support
- Communicate the importance of password security to their respective staff
- Maintain connectivity infrastructure between LEA and VCOE

9.32



EDUCATING LEARNERS FOR THE 21ST CENTURY

Agenda Item Details

Meeting	Jun 29, 2022 - RSD Regular Board Meeting
Category	9. Consent
Subject	9.32 Approval of the Taft Electric Co. Proposal for Rio Vista MPR Lighting Replacement and Upgrade
Access	Public
Type	Action (Consent)
Preferred Date	Jun 29, 2022
Absolute Date	Jul 01, 2022
Fiscal Impact	Yes
Dollar Amount	108,700.00
Budgeted	Yes
Budget Source	ESSER
Recommended Action	Staff recommends approval of the proposal from Taft Electric Company for both scopes A & B.

Public Content

Speaker: Jarkko Myllari

Rationale: A third of the existing, old stage lights in the Rio Vista MPR are out and need to be replaced. In anticipation of the currently working old lights going out in the near future, we would like to replace all of the them in one. This save costs and to avoid delays in the use of the system. Since parts of the current wiring and control system are incompatible to run the stage and houselights, we would like to rewire the existing light fixtures with new, compatible cable and to install a new control console at rear control room as well as to install Cat 6 cable where it's currently missing.

[RIO VISTA MIDDLE SCHOOL MPR LIGHTING REDO QUOTE \(1\).pdf \(11,674 KB\)](#)

Administrative Content

Executive Content

Our adopted rules of Parliamentary Procedure, Robert's Rules, provide for a consent agenda listing several items for approval of the Board by a single motion. Most of the items listed under the consent agenda have gone through Board subcommittee review and recommendation. Documentation concerning these items has been provided to all Board members and the public in advance to assure an extensive and thorough review. Items may be removed from the consent agenda at the request of any board member.

TAFT ELECTRIC COMPANY

ELECTRICAL CONTRACTORS

STATE LICENSE NO. 772245

P. O. BOX 3416 - 1694 EASTMAN AVENUE - VENTURA, CALIFORNIA 93003 - (805) 642-0121 - FAX (805) 650-9015

ELECTRICAL PROPOSAL & SCOPE OF WORK **RIO SCHOOL DISTRICT, "LIGHTING REDO IN MPR"-BID #1625**

MARCH 15, 2022

We are pleased to present our scope of work and proposal for the above project. We are a union Contractor, California Contractor's License #772245/C-10. Taft Electric Company will furnish and install the electrical material required per job walk. Our price for this work, including Taft Electric's qualifications and exclusions listed below is as follows:

BASE BID ELECTRICAL.....SCOPE A: \$39,600
SCOPE B: \$69,100

SCOPE OF WORK:

A: Rewire existing light fixtures with new MC cable to include 2 dimming wires to each light. Supply new control console at rear control room and install new modules in existing panel on stage for control. Install new led lights on back of stage ceiling, 10 total. Pull new cat 6 cabling where needed, install 4 new switching locations (reuse existing pathways down to switch from ceiling space), go through start up and commissioning for new board and controls onsite.

B: Demo existing lights. Replace existing theater lights, cabling and controls. Supply new control console at rear control room and install new modules in existing panel on stage for control.

QUALIFICATIONS:

Bid based on work performed during normal working hours of 6am-3pm Monday through Friday

Overtime, weekend, and holiday rates do not apply

Lift rental included for both Scopes of Work

For SCOPE A: Existing light fixtures to remain and be reused, only stage recessed lights to be replaced

*New lights provided will be for theater lights or led stage recessed lights behind stage

For SCOPE B: Theater lights to be replaced, old lights demoed.

EXCLUSIONS:

- HVAC, DDC, CAMERA, SECURITY, T-STAT and EMS equipment
- Access panels, fire rated fixtures and cabinet enclosures
- All formed and finished concrete, housekeeping pads, and conduit curbs
- Slack and seismic wires for recessed fixtures, surface fixtures and ceiling devices
- All additional seismic and or structural support, engineering, and upgrades
- MEP design engineering coordination requirements, cost, and labor
- Cutting, patching, repair and replacement of pavement, concrete, and sidewalk
- CA Title 24 design, engineering and regulatory requirements and cost
- SWPPP, implementation, installation, cost, and fees
- New light fixtures* and or electrical equipment, panels, upgrades, etc.
- Cost of a bond, we are bondable at an adder of 1%
- Painting, patching and drywall repair
- Temporary power and lighting
- All permit costs and fees.
- Utility charges and fees.
- Surveying and staking.
- Trenching and backfill

If you have any questions, please do not hesitate to contact the undersigned.

Sincerely,

Mark Tovias
TAFT ELECTRIC COMPANY
Service Department Manager
805.642.0121
mtovias@taftelectric.com

QuickQ 10



CHAMQUICKQ10

Features

- 1 Universe Console, ideal for conventional and LED fixture control
- Intuitive Smart phone style Interface
- Inbuilt Wi-Fi for connection of iOS and Android remotes
- Large 9.7" Multi-touch display
- Multi-Touch gesture support for fixture control
- RDM Support for RDM Autopatch
- Free QuickQ designer offline software
- 1 Cue Stack and 2 Chase playbacks
- Multi Function fixture faders with Fixture, Group or Cue mode
- Supports connection to Free MagicVis Visualiser

Hardware Specifications

- Inbuilt Wi-Fi
- Encoders: 2 dedicated Hue & Saturation
- DMX Ports: 1
- Network ports: 1, with Artnet & sACN support
- Audio: In & Out
- External Monitor: 1 HDMI
- USB Ports: 2
- Multi-Function Fixture faders: 20
- Cue Stack Playbacks: 1
- Chase Playbacks: 2

Software Specifications

- Universes: 1
- Channels: 512
- Number of fixtures: limited by channels supported
- RDM Autopatch for fast show patching
- Fixture library of over 25,000 fixture files
- Built In FX generator
- Colour picker and Gel inbuilt Gel library
- Offline designer software available for Windows and Mac



5-Pin DMX Extension

- **Length:** 5 ft (1.5 m), 10 ft (3 m), 25 ft (7.6 m)

We use cookies to ensure that we give you the best experience on our website. If you continue to use this site we will assume that you are happy with it.

[Ok](#) [Privacy policy](#)



CTC-50G

- **Color:** Black anodized
- **Load capacity:** 550 lb (250 kg)
- **Fits:** 2 inch (50 mm) truss
- **Weight:** 1.0 lb (0.45 kg)
- **Dimensions:** 5.1 x 1.0 x 6.5 in (130 x 25 x 165 mm)

We use cookies to ensure that we give you the best experience on our website. If you continue to use this site we will assume that you are happy with it.

[Ok](#) [Privacy policy](#)



Ovation E-910FC

Ovation E-910FC is a high-performance ERS-style fixture with full RGBA-Lime color mixing and Color Temperature presets of 2800 to 6500 K that match the output of a tungsten source to perfection. Control options include full 16-bit dimming (per color and master), selectable PWM, RDM and onboard dimming curve selection. Also accessible is our Virtual Color Wheel which matches popular gel colors.



At a Glance

- Full Color LED (RGBAL) ERS-style lighting fixture for theatre, film and production
- Ultra smooth 16-bit dimming of master dimmer and individual colors
- Flat, even field of light with superior color mixing
- Virtual Color wheel with color matched to popular gel colors
- Color Temperature Presets from 2800 K to 6500 K with high CRI & CQS
- RDM (Remote Device Management) for added flexibility
- Adjustable PWM (Pulse Width Modulation) to avoid flickering on camera
- Virtually silent operation for use in studio and theatre applications
- Works perfectly with industry standard lens tubes and accessories

Specifications

Optical

- Light Source: 91 LEDs (18 red, 18 green, 19 blue, 18 amber, 18 lime green) 3 W, (722 mA), 6031 K, 50,000 hours life expectancy
- Color Temperature (range): 2800 to 6500 K
- Color Temperature (at full): 6031 K
- CRI (3200 K): 82
- Beam Angle (w/14° lens): 11°
- Beam Angle (w/19° lens): 19°
- Beam Angle (w/26° lens): 24°
- Beam Angle (w/36° lens): 28°
- Beam Angle (w/50° lens): 41°
- Beam Angle (w/15°-30° lens)(Narrow): 13°
- Beam Angle (w/15°-30° lens)(Wide): 24°
- Beam Angle (w/25°-50° lens)(Narrow): 23°
- Beam Angle (w/25°-50° lens)(Wide): 36°
- Field Angle (w/14° lens): 14°
- Field Angle (w/19° lens): 19°
- Field Angle (w/26° lens): 26°
- Field Angle (w/36° lens): 34°
- Field Angle (w/50° lens): 51°
- Field Angle (w/15°-30° lens)(Narrow): 15°
- Field Angle (w/15°-30° lens)(Wide): 29°
- Field Angle (w/25°-50° lens)(Narrow): 26°
- Field Angle (w/25°-50° lens)(Wide): 50°
- Lumens (w/14° lens):
- Lumens (w/19° lens): 3,236
- Lumens (w/26° lens): 4,316
- Lumens (w/36° lens): 3,918
- Lumens (w/50° lens): 3,813
- Illuminance (w/14° lens): 4,420 lux @ 5 m
- Illuminance (w/19° lens): 2,530 lux @ 5 m
- Illuminance (w/26° lens): 1,720 lux @ 5 m
- Illuminance (w/36° lens): 1,020 lux @ 5 m
- Illuminance (w/50° lens): 457 lux @ 5 m
- Illuminance (w/15°-30° lens)(Narrow): 4,260 lux @ 5 m
- Illuminance (w/15°-30° lens)(Wide): 1,620 lux @ 5 m
- Illuminance (w/25°-50° lens)(Narrow): 1,790 lux @ 5 m
- Illuminance (w/25°-50° lens)(Wide): 825 lux @ 5 m
- Selectable PWM: 600 Hz, 1,200 Hz, 2,000 Hz, 4,000 Hz, 6,000 Hz, 25,000 Hz

Dynamic Effects

- Dimmer: Electronic
- Shutter/Strobe: Electronic
- Focus: Manual
- Strobe Rate: 0 to 28 Hz
- Standalone Color Mixing: Yes
- Color Temperature Presets: Yes
- Dim Modes: 4
- Built-in Automated Programs: Yes

Construction / Physical

- Dimensions (fixture only): 19.49 x 11.22 x 19.17 in (495 x 285 x 487 mm)
- Dimensions (w/14° lens extended): 28.74 x 11.22 x 19.17 in (730 x 285 x 487 mm)
- Dimensions (w/26° lens extended): 25.91 x 11.22 x 19.17 in (658 x 285 x 487 mm)
- Dimensions (w/15°-30° lens): 32.87 x 14.61 x 14.61 in (835 x

Connections

- Power Connection: Edison (Local) plug to Neutrik powerCON
- Power Connection: Edison (Local) plug to Neutrik powerCON
- Power Output: Neutrik powerCON
- Data Connectors: 5-pin XLR
- Cable Length (power): 5 ft (1.5 m)

- 371 x 371 mm)
- Dimensions (w/25°-50° lens): 27.17 x 14.61 x 14.61 in (690 x 371 x 371 mm)
- Weight (fixture only): 15.4 lb (7.1 kg)
- Weight (w/14° lens): 20.8 lb (9.43 kg)
- Weight (w/26° lens): 19.8 lb (9 kg)
- Weight (w/15°-30° lens): 29.4 lb (13.3 kg)
- Weight (w/25°-50° lens): 27 lb (12.2 kg)
- Exterior Color: Black
- Gobo Size (Optional): "A": 100 mm (outside), 75 mm (image), 2.5 mm (max. thickness)
- Gobo Size (Optional): "B": 86 mm (outside), 64.5 mm (image), 2.5 mm (max. thickness)
- Accessory Holder/Gel Frame Size (19°, 26°, 36°, and 50° lens): 6.25 in (159 mm)
- Accessory Holder/Gel Frame Size (15°-30° lens): 7.5 in (191 mm)
- Accessory Holder/Gel Frame Size (25°-50° lens): 7.5 in (191 mm)

Control

- Protocol(s): DMX, RDM
- DMX Channels: 3, 5, 7, 10, 12, 13, 15 or HSV
- Modes/Personalities: 7 personalities (3, 5, 7, 10, 12, 13, 15 or HSV)

Electrical

- Input Voltage: 100 to 240 VAC, 50/60 Hz (auto-ranging)
- Power Linking: 6 units @ 120 V; 11 units @ 208 V; 12 units @ 230 V
- Power and Current: 240 W, 2.006 A @ 120 V, 60 Hz
- Power and Current: 234 W, 1.2 A @ 208 V, 60 Hz
- Power and Current: 234 W, 1.1 A @ 230 V, 50 Hz

Certifications / Qualifications

- CE, MET, FCC
- IP Rating: IP20, dry location

What's Included

- OVATION E-910FC
- Neutrik powerCON power cord

Ovation Ellipsoidal HD Lens Tubes

SPECIFICATIONS

Optical

- Installed Optics (5°): 5°
- Installed Optics (10°): 10°
- Installed Optics (14°): 14°
- Installed Optics (19°): 19°
- Installed Optics (26°): 26°
- Installed Optics (36°): 36°
- Installed Optics (50°): 50°

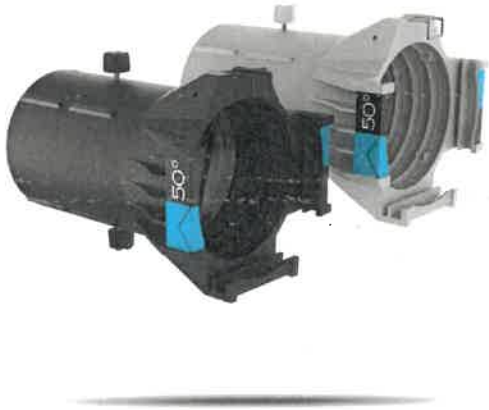

FEATURES

- Fixed focal length lens tube for the Ovation ellipsoidal fixtures
- Dual aspheric lenses provide precise focus for crisp gobo projection
- Integrated gel frame holder and gel frame included

Construction / Physical

- Dimensions (5° lens): 24.5 x 14.17 x 14.48 in (622.4 x 360 x 368 mm)
- Dimensions (10° lens): 15.78 x 12.16 x 12.48 in (400.9 x 309 x 317 mm)
- Dimensions (14° lens): 12.7 x 7.8 x 8 in (323 x 198 x 204 mm)
- Dimensions (19°, 26°, 36°, and 50° lens): 9.64 x 6.85 x 6.85 in (245 x 174 x 174 mm)
- Weight (5°): 5.8 lb (2.7 kg)
- Weight (10°): 3.8 lb (1.8 kg)
- Weight (14°): 5.4 lb (2.4 kg)
- Weight (19°): 4.2 lb (1.9 kg)
- Weight (26°): 4.0 lb (1.8 kg)
- Weight (36°): 3.8 lb (1.7 kg)
- Weight (50°): 4.0 lb (1.8 kg)
- Accessory Holder/ Gel Frame Size (5° lens): 14 in (356 mm)
- Accessory Holder/ Gel Frame Size (10° lens): 12 in (304 mm)
- Accessory Holder/ Gel Frame Size (14° lens): 7.50 in (191 mm)
- Accessory Holder/Gel Frame Size (19°, 26°, 36°, and 50° lens): 6.25 in (159 mm)

Certifications / Qualifications

- IP Rating: IP65, outdoor/wet

What's Included

- OHDLENS5
- OHDLENS10

- OHDLENS14
- OHDLENS19
- OHDLENS26
- OHDLENS36
- OHDLENS50

Ovation P-56FC



SPECIFICATIONS

Optical

- Light Source: 48 LEDs (10 red, 10 green, 8 blue, 8 amber, 12 lime) 3 to 5 W, (1 A), 50,000 hours life expectancy
- Color Temperature (range): 2800 to 6500 K
- Color Temperature (at full): 4889 K
- CRI (3200): 90
- Beam Angle (Medium Lens): 24°
- Beam Angle (Wide Lens): 73°
- Field Angle (Medium Lens): 41°
- Field Angle (Wide Lens): 105°
- Lumens (Medium Lens): 5,436
- Lumens (Wide Lens): 5,216
- Illuminance (Medium Lens): 1,250 lux @ 5 m
- Illuminance (Wide Lens): 197 lux @ 5 m
- Selectable PWM: 600 Hz, 1,200 Hz, 2,000 Hz, 4,000 Hz, 6,000 Hz, 25,000 Hz

Dynamic Effects

- Dimmer: Electronic
- Shutter/Strobe: Electronic
- Strobe Rate: 0 to 30 Hz
- Standalone Color Mixing: Yes
- Color Temperature Presets: Yes
- Dim Modes: 4
- Built-in Automated Programs: Yes

Optional Accessories

- Professional Clamps: CTC-50HC, CTC-50HCN
- Neutrik® powerCON® cables
- 3-pin or 5-pin DMX Cables
- Color Blending Filters: DF60X1D, DF20D
- Ovation P-56FC
- Ovation 60 deg, 7.5" Honeycomb

FEATURES

- Full color PAR style fixture with homogenized single source of light
- Interchangeable lens plates included for medium and wide beam angles
- Flat, even field of light
- Quiet operation for use in any situation with fan speed control
- RDM and variable Pulse Width Modulation for setup ease
- Accepts standard 7.5" beam shaping accessories
- 16-bit dimming resolution for smooth fades

Construction / Physical

- Dimensions: 12.48 x 12.83 x 14 in (317 x 326 x 363 mm)
- Weight: 12.2 lb (5.6 kg)
- Exterior Color: Black
- Housing Material: Aluminum die-cast
- Accessory Holder/Gel Frame Size: 7.5 in (191 mm)

Connections

- Power Connection: Edison (Local) plug to Neutrik powerCON
- Power Input: Neutrik powerCON
- Power Output: Neutrik powerCON
- Data Connectors: 3- and 5-pin XLR
- Cable Length (power): 5 ft (1.5 m)

Control

- Control Protocol: DMX, RDM
- DMX Channels: 1, 3, 5, 7, 10, 12, 13, 15 or HSV
- Modes/Personalities: 9 personalities (1, 3, 5, 7, 10, 12, 13, 15, HSV)

Electrical

- Input Voltage: 100 to 240 VAC, 50/60 Hz (auto-ranging)
- Power Linking: 7 units @ 100 V; 9 units @ 120 V; 16 units @ 208 V; 18 units @ 230 V; 18 units @ 240 V
- Power and Current: 167 W, 1.740 A @ 100 V, 60 Hz
- Power and Current: 164 W, 1.413 A @ 120 V, 60 Hz
- Power and Current: 158 W, 0.813 A @ 208 V, 60 Hz
- Power and Current: 156 W, 0.747 A @ 230 V, 50 Hz
- Power and Current: 155 W, 0.716 A @ 240 V, 50 Hz

Certifications / Qualifications

- CE, MET, FCC
- IP Rating: IP20, dry location
- Temperature (Ambient): -4 °F to 113 °F (-20 °C to 45 °C)

What's Included

- Ovation P-56FC
- Neutrik powerCON power cord
- Gel frame holder (7.5 in/191 mm accessories)
- Medium and Wide Lens



SC-07 Safety Cable

- **Load Capacity:** 77.2 lb (35 kg)
- **Length:** 35 in (890 mm)
- **Thickness:** 0.127 in (3.25 mm)
- **Weight:** 0.2 lb (.1 kg)

Clamps

We use cookies to ensure that we give you the best experience on our website. If you continue to use this site we will assume that you are happy with it.

[OK](#) [Privacy policy](#)

OVERVIEW

The nCM xx RJB family of nLight ceiling/surface mount occupancy sensors provide a range of networked sensor solutions for applications with finished ceilings (e.g. ceiling tiles, sheetrock, plaster). nCM xx RJB family sensors utilize 100% digital Passive Infrared (PIR) detection and are available with several lens options, providing flexibility for multiple mounting height and coverage pattern requirements. Dual technology occupancy detection can also be added as an option for applications where occupants are stationary for long periods of time. nCM xx RJB family sensors are also available with an optional auxiliary low voltage relay for simple integration with a BMS system or other building system.

nCM xx RJB family sensors are powered via the nLight network bus and typically communicate with one or more nLight enabled luminaires (e.g. Lithonia VTLED Series) or nLight relay/dimming packs to enable control of fixtures individually or in groups. These configurations work standalone and do not require a connection to a larger nLight network.

FEATURES

- 100% digital PIR detection
- Optional dimming photocell (ADCX option)
- Optional auxiliary low voltage relay (AR option) for dry contact output - relay only tracks occupancy by default, ignoring switch and photocell commands
- LED status indicator
- Adjustable settings (e.g. occupancy time delays, photocell set-points) via push-button or SensorView software application
- Broadcasts occupancy and photocell information over a local nLight channel
- Remotely upgradeable firmware

Buy American

BAA variants of this product are assembled in the USA and meet the Buy America(n) government procurement requirements under FAR, DFARS and DOT. Please refer to www.acuitybrands.com/buy-american for additional information.

Warranty

Five-year limited warranty. This is the only warranty provided and no other statements in this specification sheet create any warranty of any kind. All other express and implied warranties are disclaimed. Complete warranty terms located at: www.acuitybrands.com/support/warranty/terms-and-conditions

Note: Actual performance may differ as a result of end-user environment and application.

Specifications subject to change without notice.

A+ Capable

This item is an A+ capable component, which has been designed and tested to provide out-of-the-box luminaire compatibility with simple commissioning, when included as part of an A+ Certified™ Solution.

To learn more about A+, visit www.acuitybrands.com/aplus.



nCM xx RJB
nCM PDT xx RJB



nCM 9 RJB
nCM PDT 9 RJB



nCM 10 RJB
nCM PDT 10 RJB



nCM 6 RJB



ORDERING INFORMATION

nCM xx RJB		Example: nCM PDT 9 ADCX RJB				
Series / Detection	Coverage Type	Options (See Below)	RJ45 Port Location	Buy America(n) ²		
nCM PIR Detection nCM PDT Dual Tech (PIR/ Micro-phonics)	9 Small Motion 360° 10 Large Motion 360° 6 High Mount 360° (not available with PDT version)		RJB Rear RJ45 (CAT5e patch cable & RJ45 splitter included)	blank Standard BAA Buy America(n) Act Compliant		

nCM xx RJB Options					
Photocell	Auxiliary Relay	Preset Type ¹	Time Delay	Temp/ Humidity	
[blank] Standard (No photocell) ADCX Automatic Dimming Control (of remote dimming output)	[blank] None AR Low Voltage Aux. Relay	[blank] Single Time Delay 2P Dual Time Delay	[blank] Standard 15M 15 Minutes 20M 20 Minutes 30M 30 Minutes	[blank] Standard LT Low Temp / High Humidity	

NOTES:

1. Not available with AR or ADCX options.
2. Not available with AR, 2P, Time Delay, or LT options

COVERAGE PATTERNS*

SMALL MOTION 360° (Model # nCM 9/nCM PDT 9¹)



- Best choice for small motion (e.g. hand movements) detection
- 360° conical shaped pattern
- Provides 12 ft (3.66 m) radial coverage (~500 ft²) when mounted to standard 9 ft (2.74 m) ceiling
- 8 to 15 ft (2.44 to 4.57 m) mounting heights provide 10 to 20 ft (3.05 to 6.10 m) radial coverage

SIDE VIEW

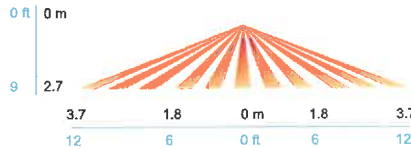

TOP VIEW

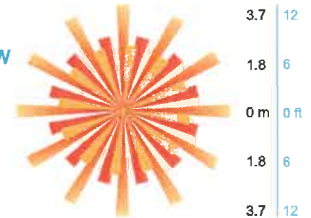

¹ Sensors with Microphonics™ provides overlapping detection of human activity over the complete PIR coverage area. Advanced filtering is also utilized to prevent non-occupant noises from keeping the lights on.

LARGE MOTION 360° (Model # nCM 10/nCM PDT 10¹)



- Best choice for large motion detection (e.g. walking)
- 360° conical shaped pattern
- Provides ~24 ft (7.32 m) radial coverage (~2000 ft²) when mounted at 9 ft (2.74 m)
- 7 to 15 ft (2.13 to 4.57 m) mounting heights provide 16 to 36 ft (4.88 to 10.97 m) radial coverage
- Detection range improves when walking across beams compared to into beams

SIDE VIEW



TOP VIEW

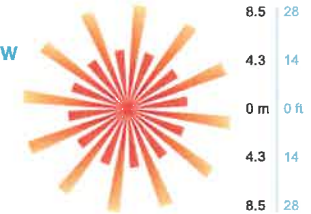

¹ Sensors with Microphonics™ provides overlapping detection of human activity over the complete PIR coverage area. Advanced filtering is also utilized to prevent non-occupant noises from keeping the lights on.

HIGH MOUNT 360° (Model # nCM 6)



- Best choice for 15 to 45 ft (4.57 to 13.72 m) mounting heights
- 15 to 20 ft (4.57 to 6.10 m) radial coverage overlaps area lit by a typical high bay fixture
- Excellent detection of large motion (e.g. walking) up to 35 ft (10.76 m)
- Excellent detection of extra large motion (e.g. forklifts) up to a 45 ft (13.72 m)

LOW VIEW

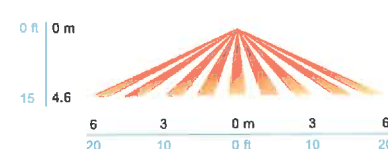

HIGH VIEW

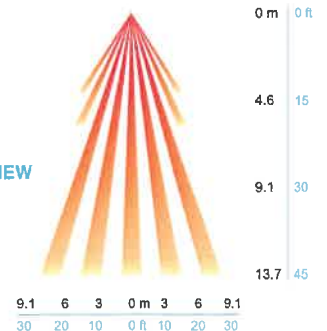

* Coverage pattern shown is derived from NEMA WD7 testing

TYPICAL APPLICATIONS

Wiring to an nLight Relay Pack

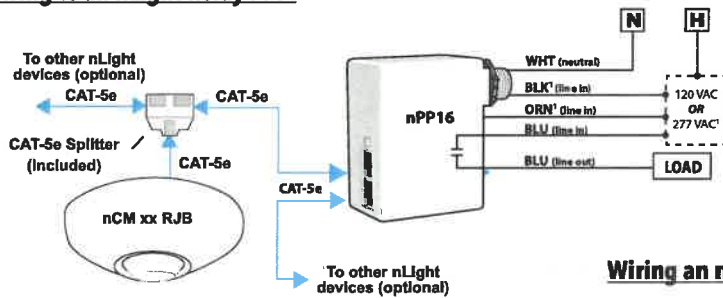

Wiring an nCM xx ADCX RJB to an nLight Dimming Pack

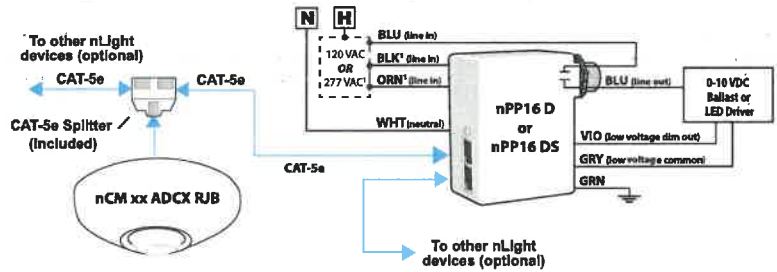

Wiring to an nLight Enabled Luminaire

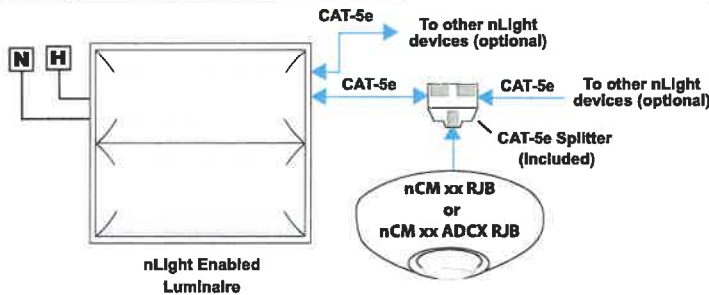

TYPICAL APPLICATIONS

The following instructions are for mounting sensor directly to a ceiling tile or sheetrock surface. Sensor's mounting holes also align with standard round fixture or single gang handy box (screws not provided).

1. Using template included with unit, mark spots on ceiling tile/sheetrock for cable hole and mounting anchors/screws
2. Drill 1/2" hole through ceiling surface at location indicated on template
3. Insert provided anchors into ceiling surface at locations indicated on template
4. Remove provided RJ-45 splitter from sensor's attached CAT5e cable and then thread cable (and low voltage wires if -AR option included) through hole from underside
5. Mount sensor to anchors using two screws provided
6. Attach provided RJ45 splitter device (model **CAT5 Y**) above ceiling to cable from sensor (see diagram on right)
7. Interconnect CAT-5e cables to/from rest of nLight zone to RJ45 splitter
8. Once power is received via CAT-5e connection, all devices in zone will automatically begin functioning together according to each device's defaults
9. Install decorative sensor lid by rotating clockwise
10. Refer to included instruction card for default settings and directions on push-button programming.

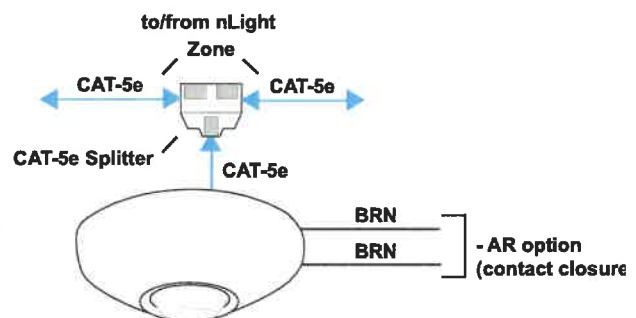

SPECIFICATIONS

Electrical

Input Ratings 15-24VDC, 3mA, Class 2 (nLight network power)

Output Ratings 24 VAC/VDC, 1A - Resistive (AR option)

Relay Type Latching (AR option)

Standards/ Ratings Energy Management Equipment, UL916 (E167435)

Mechanical

Dimensions 4.55"W x 1.55"D (116mm x 40mm)

Mounting Single-Gang or Octagonal Box, Surface Mount

Color White

Finish Matte

Connection Type RJ-45 nLight Network Ports (2 ports via included RJ-45 splitter)
Low-Voltage Leads (AR option)

Environmental

Warrantied Operating Temperature Standard: 14°F to 185°F (-10°C to 85°C)
PDT option: 14°F to 140°F (-10°C to 60°C)
LT option: -4°F to 185°F (-20°C to 85°C)
PDT LT options: -4°F to 140°F (-20°C to 60°C)

Relative Humidity Up to 90%, Non-Condensing

Standards/ Ratings RoHS

General

Standards/ Ratings System Component to aid in compliance with Title 24, ASHRAE 90.1, IECC

OVERVIEW

The nComKit is a commissioning device for nLight Wired stand-alone zones. The device uses low voltage RJ45 connection to communicate with the nLight Wired network and a USB connection to allow for programming using SensorView on a PC. It works by discovering all of the devices that are daisy-chained up to a bridge port to enable updating and configuring for the discovered devices.

FEATURES

- No Assembly Required - The single piece device offers enhanced durability and convenience
- Extended Cable Length - To reach a variety of ceiling heights from a laptop
- Plug-and-Play - Simply plug into the nLight device and your laptop to interface with the SensorView application for easy configuration



Warranty

Five-year limited warranty. Complete warranty terms located at: www.acuitybrands.com/support/warranty/terms-and-conditions

Note: Actual performance may differ as a result of end-user environment and application. Specifications subject to change without notice.



nCOMKIT nLight Commissioning Kit



ORDERING INFORMATION

nCOMKIT		Example: nCOMKIT G2
Series	Generation	
nCOMKIT nLight Commissioning Kit	G2 Single Piece Device	

OVERVIEW

The nLight® UNITOUCH is an elegant capacitive touch screen wall switch that leverages the perfect blend between aesthetic design and intuitive user experience to enable control of any nLight controlled space. Developed with end-users first at mind, the nLight® UNITOUCH is an easy-to-install wall switch that enables control of nLight-enabled devices, scenes, shades and channels behind a multi-user access level architecture.

Equipped with Bluetooth(R) Low Energy (BLE), the nLight UNITOUCH enables users the ability to remotely control lights and shades through the MyPersonify mobile app.

FEATURES

- 3.5" full-color responsive capacitive touch screen
- Slim and compact form factor
- Simple and intuitive user interface
- Proximity screen sensor for auto "wake-up"
- Customizable Screen Saver Image
 - Supported file formats: JPG, PNG
 - Optimal resolution: 320x480
- Full alpha-numeric nomenclature for scenes and lighting channels
- Controls up to 16 On/Off/Dim lighting and shade channels
- Controls up to 16 scene controls
- Enables on-screen customization of all preset scenes, On/Off/Dim lighting and shade channels
- Optional password protected lockout screen
- Multi-level password/PIN protection
- Enables wireless control of scenes, lights and shades through the MyPersonify mobile app
- Mounts to a single gang switch box
- Complies with California Civil Code Title 1.81.26, Security of Connected Devices, approved under Senate Bill No. 327 (2018)

TRY ME!  **Download the App**
 Search for "my PERSONIFY"
 

Warranty

Five-year limited warranty. Complete warranty terms located at: www.acuitybrands.com/support/customer-support/terms-and-conditions

Note: Actual performance may differ as a result of end-user environment and application. Specifications subject to change without notice.



*nLight UNITOUCH™
Touch Screen Wall
Switch*



ORDERING INFORMATION

Example: nPOD TOUCH WH		
Switch	Power Supply Type	Color
nPOD TOUCH	[blank] Includes PS150 PS347 Includes PS150-347 NPWS No Power Supply	WH White BK Black

The nLight UniTouch is equipped with two RJ-45 ports to facilitate CAT5e daisy-chain connection with other nLight-enabled devices, and a set of power terminals where low voltage power is connected (from the provided PS 150 power supply module).

Mounting Instructions

STEP 1

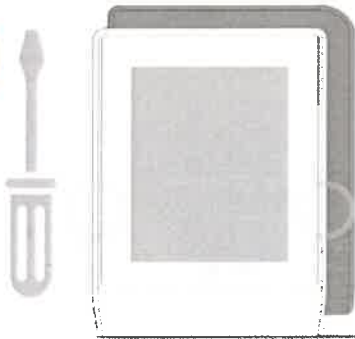

To mount, the faceplate must be detached from the backplate. This will require an appropriately sized tool (i.e., flat-head screwdriver) that can fit in the release tab.

STEP 2

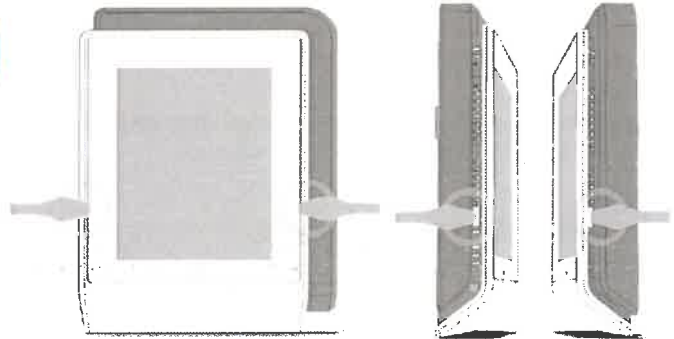

Using the appropriately sized tool, press in the release tabs on each side of the device until the backplate is noticeably released.

STEP 3

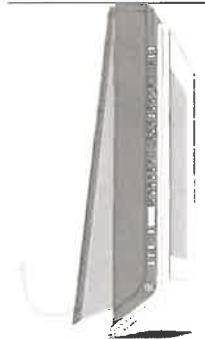

Pull the backplate out from the bottom, away from the faceplate, as pictured.

STEP 4

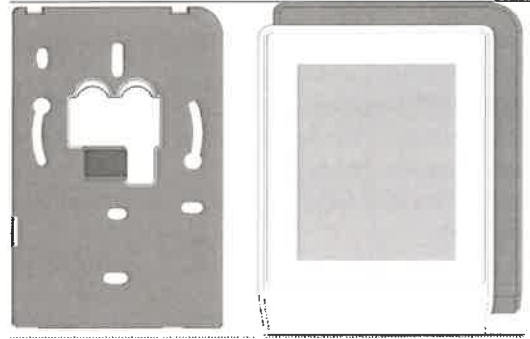

Device should be separated into two pieces, backplate and faceplate. The backplate will be used to mount onto a wall gang box.

STEP 5



Pull all wires out of the wall and run them through the central hole of the backplate. Screw the backplate onto the wall.

STEP 6

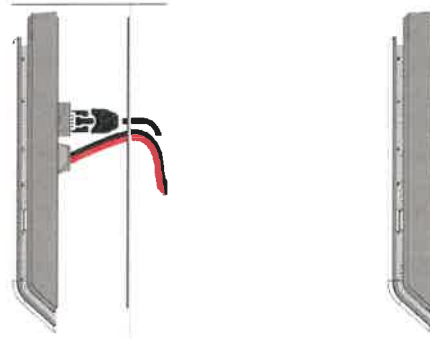

Plug the wire(s) into the connector(s), then gently push the excess wiring back into the wall. Reattach the front plate and ensure that it clips tightly in place. Tighten the security screw, if applicable.

SPECIFICATIONS

Electrical

Input Ratings 15-24VDC, 60mA, Class 2 (via included PS-150 or PS-150-347 power supply)

Standards/Ratings Energy Management Equipment,
FCC Rules Part 15, Subpart B Class B

Mechanical

Dimensions 5.18"H x 3.37"W x 0.75"D (131.5mm x 85.5mm x 19mm)

Mounting Single-Gang Box or Low Voltage Ring

Connection Type RJ-45 nLight Network Ports (2)
Low-Voltage Terminals

Color: White, Black

Environmental

Warrantied Operating Temperature Standard: 32°F to 122°F (0°C to 50°C)

Relative Humidity Up to 90%, Non-Condensing

Standards/ Rating RoHS

General

Standards/ Rating System Component to aid in compliance with Title 24, ASHRAE 90.1, IECC

Regulatory cULus Listed (E228719)

OVERVIEW

The nPODMA Series WallPods are single gang nLight-enabled decorator wall switches that enable toggle/raise/lower/scene control of lighting zones. Equipped with soft-click push-buttons, and a green LED indicator for each button, these devices allow field replaceable and custom engraved button options. nPODMA WallPods communicate with other nLight devices, via CAT-5e cable, through RJ-45 connectors and can be daisy-chained to work with nLight power packs and/or nLight-enabled fixtures to provide switch control operations.

The scene control option presents a convenient method of selecting a custom lighting control scene for spaces in which installed, or requesting a global profile scene be run across several remote zones. By default, scene control wall switches are configured as on/off toggle switches and are to be customized programmatically through the SensorView software.

*In order to utilize a blink warning, system gateway and additional programming is required.

FEATURES

- Communicates with nLight network
- Remotely configurable/upgradeable
- Soft-click push-button control
- Sets lights to one of two or four preset levels with single button push (nPODMA xL versions only)
- Scene controllers run locally stored scenes or global scenes (stored on gateway)
 - Capable of Programming 4 Different Scene Types
 - Local "Profile" Scene – Modifies the operational configuration of up to 80 devices in the local zone. Stopping scene will revert devices to default settings.
 - Local "Preset" Scene – Modifies on/off/dim levels for up to 16 local switch groups. Exit scene through additional "preset" scene or WallPod control.
 - Global "Profile" Scene – Modifies the operational configuration of any devices on the system. Stopping scene will revert devices to default settings. Scene is stored on the system Gateway.
 - Global "Preset" Scene – Modifies on/off/dim levels for up to 128 global switch groups. Exit scene through additional "preset" scene or WallPod control.
- Easy-to-install screwless wall plate design offers a clean, uninterrupted aesthetic for a more refined look in the space.
- A full range of color options provides a variety of choices for your building designs with the assurance that the housing and the wall plate match.
- 1, 2, or 4 channel on/off
- 1, 2, or 4 channel raise/lower
- "Dynamic" options for custom button names when pairing with Acuity Brands nTUNE fixtures

CUSTOM BUTTON ENGRAVING

- Standard Button labeling is shown on back
- Custom lettering for units can be specified and ordered at: [nGrave Form](#)
- To ensure color uniformity, ordering templates facilitate specifying all buttons on a unit as custom lettered. Replacing single buttons not recommended
- Buttons may ship separately and require field installations

Buy American

BAA variants of this product are assembled in the USA and meet the Buy America(n) government procurement requirements under FAR, DFARS and DOT. Please refer to www.acuitybrands.com/buy-american for additional information.

Warranty

Five-year limited warranty. This is the only warranty provided and no other statements in this specification sheet create any warranty of any kind. All other express and implied warranties are disclaimed. Complete warranty terms located at: www.acuitybrands.com/support/warranty/terms-and-conditions

Note: Actual performance may differ as a result of end-user environment and application. Specifications subject to change without notice.



This item is an A+ capable component, which has been designed and tested to provide out-of-the-box luminaire compatibility with simple commissioning, when included as part of an A+ Certified™ Solution.

To learn more about A+, visit www.acuitybrands.com/aplus.



nPODMA
Wallpod: On/Off & On/
Off+Raise/Lower

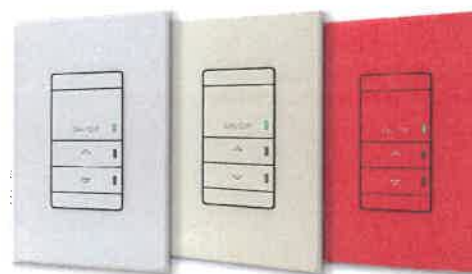

ORDERING INFORMATION

nPODMA		Example: nPODMA DX WH									
Series	Poles & Scenes	Dimming Control		Dynamic		Color		Temp/Humidity		Buy America(n) ⁶⁷	
nPODMA	[blank] None 2P Two channels 4P Four channels 2L ¹ Two levels 2L AB ¹ High/low step control 4L ² Four levels with raise/lower 1SB ¹ 1 Scene control (2 buttons) 2S 2 Scene control (2 buttons) 2SB ¹ 2 Scene control (4 buttons) 4S 4 Scene control (4 buttons) 4SB ¹ 4 Scene control (8 buttons)	[blank] Standard DX On/off + raise/lower control	[blank] Standard CCT ³ Correlated color temperature GRSC ⁵ Grayscale COLOR ⁵ Color control EDUTW ⁶ Tuneable White	WH White IV Ivory GY Gray AL Lt Almond BK Black RD Red	[blank] Normal LT Low temp	[blank] Standard BAA Buy America(n) Act Compliant					

ACCESSORIES							
Series	# of Gangs	Mounting		Color		Packaging	
WS xPODA Wall Plates (Standard) SSW ¹⁰ Sealed Cover	1 GNG Single Gang	[blank] Standard	WH White IV Ivory GY Gray AL Lt Almond	BK ⁹ Black RD Red VP ⁹ Variety Pack	[blank] Single Unit ¹¹ M5 ⁹ 5 Pack M6 ^{8,9} 6 Pack		

Notes

1. Not available with DX option.
2. Only available with DX option.
3. Only available with 2P DX version.
4. Only available with 4S and 4S DX versions.
5. Only available with 2P DX and 4S DX versions.
6. Only available in WH, IV, or GY.
7. Not available in WH, IV, or GY.
8. Only available for Variety Packs.
9. Not available for SSW Series.
10. Ships with custom screwless wall plate.
11. Single units only available with SSW series.

All nPODMA switches are shipped with wall plates and mounting flanges (WS XPODA), and mounting flanges (WS XPODA), however, the following order information is available to acquire replacement wall plates. Also compatible with the [WALLP](#) Series.

WALL SWITCH CLEANING

It will occasionally be necessary to clean the wall switches. All nPODMA switches may be wiped down with a soft cloth or paper towel dampened with glass cleaner, vinegar and water, hydrogen peroxide, or a mild abrasive. Spray a limited amount on the cloth or paper towel prior to applying. Do not spray cleaner on the switches directly, and do not wipe the switches down with a towel saturated (drips when wrung out) with cleaner.

If the ability to clean the switches using chemical spray disinfectants is desired, we recommend the use of the Sealed Screwless Wall Plate (SSW). The Sealed Screwless Wall Plate is a cover for the standard wall plate, designed with an IP54 rating. It consists of a transparent silicone rubber layer that covers the wall switch to prevent liquids from entering the wall switch while maintaining a tactile button feel. The Sealed Screwless Wall Plate is the ideal solution to help protect a wall switch from fluid entering the device while enabling the use of disinfectants recommended by the EPA for use against SARS-CoV-2, the coronavirus that causes COVID-19, which often require spraying or saturating the surface.



For more information on the [Sealed Covers](#)

WIRING

TYPICAL WIRING

Power to WallPod device is provided via the CAT-5e connection to an nLight enabled fixture, nLight power pack (e.g. **nPP16**), power supply (**nPS80**), or Bridge (**nBRG 8**).

ON/OFF

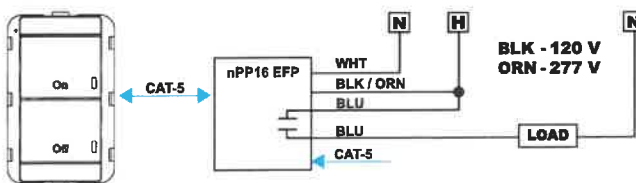

ON/OFF + DIMMING (nPODMA DX)

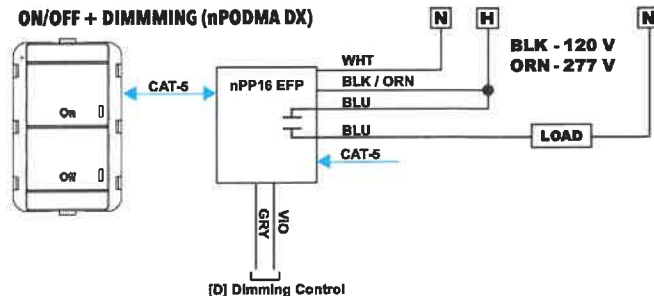

3-WAY CONFIGURATION WIRING

WallPods and/or nLight wall switch sensors can be configured together to create zones with multiple switching locations.

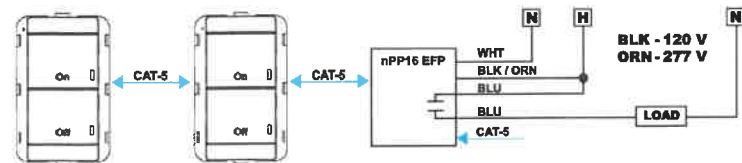

DEFAULT LABELING

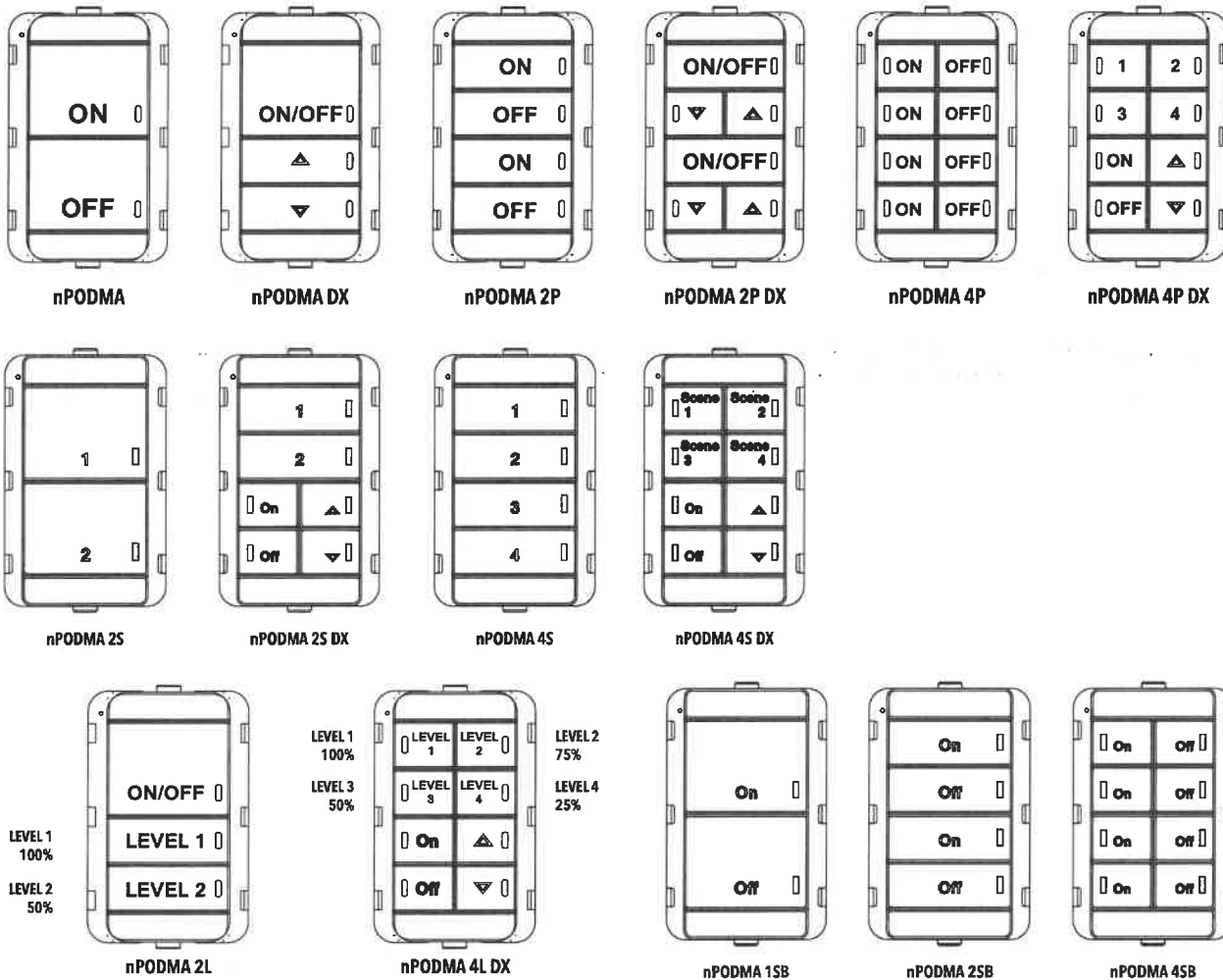

Dynamic wallpods below are paired with Acuity Brands nTUNE fixtures for out-of-box operation. Reference fixture cut sheets for additional details.

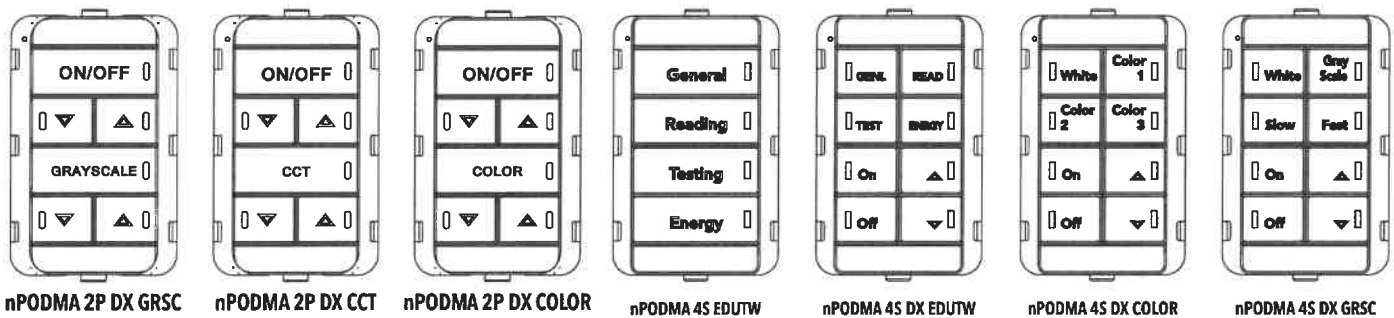

INSTALLATION

- Ensure CAT-5e cable(s) are effectively fed through the gang box
 - Push the CAT-5e cables through the back of the gang box
- Remove the wall plate from the device by pulling the sides out to expand the wall plate and release it from the mounting flanges.
- Access RJ-45 port(s) on the WallPod by sliding the plastic guard up
- Insert the CAT-5e cable(s) to the RJ-45 port(s)
- Slide the guard back onto metal strap
- Connect the unit to the gang box
 - The unit will connect to the gang box by screws, one at the top and one at the bottom
 - To ensure correct wall plate installation, drive the screws until the mounting flanges contact the wall surface. If the screws are overdriven, the mounting flanges will disengage, preventing wall plate installation. If this happens, reattach the mounting flange(s) and install to correct position. (The flanges may be reattached by inserting the two tabs in the side of the unit and pushing the part inward to engage the three snaps.)
- Reattach the wall plate
 - Expand the wall plate horizontally
 - Place the wall plate onto the unit
 - Contract the horizontally expanded wall plate onto the unit such that the side flange features seat inside the wall plate

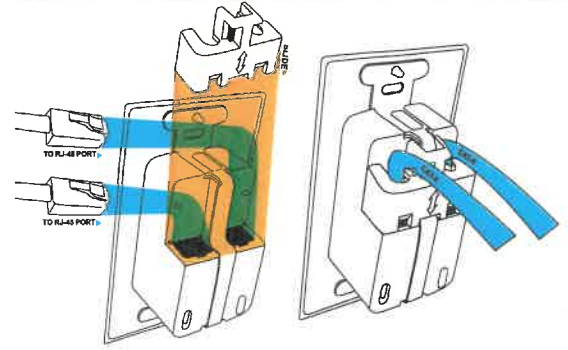

Attention! Only use non-booted CAT5e cables.

PROGRAMMING

Refer to instruction card IN-11.3 for directions on programming the sensor via the upper-most left push-button. All buttons are factory set to the matching switch channel (button 1 - channel 1, button 2 - channel 2, etc). For nPODMA 4P DX, channels to be controlled are selected first, then the control button (on/off or raise/lower).

SPECIFICATIONS

Electrical	Input Ratings	15-24VDC, 5mA, Class 2 (nLight network power)
	Standards/Ratings	Energy Management Equipment, UL916 (E167435)
Mechanical	Dimensions	2.74"H x 1.68"W x 1.63"D (70mm x 43mm x 41mm) - does not include ground strap
	Mounting	Single-Gang Box or Low Voltage Ring
	Connection Type	RJ-45 nLight Network Ports (2)
Environmental	Warrantied Operating Temperature	32°F to 140°F (0°C to 60°C) LT Option: -4°F to 140°F (-20°C to 60°C)
	Relative Humidity	Up to 90%, Non-Condensing
	Standards/ Ratings	RoHS
	Security	Complies with California Civil Code Title 1.81.26, Security of Connected Devices, approved under Senate Bill No. 327 (2018)

DATA RECEPTACLES

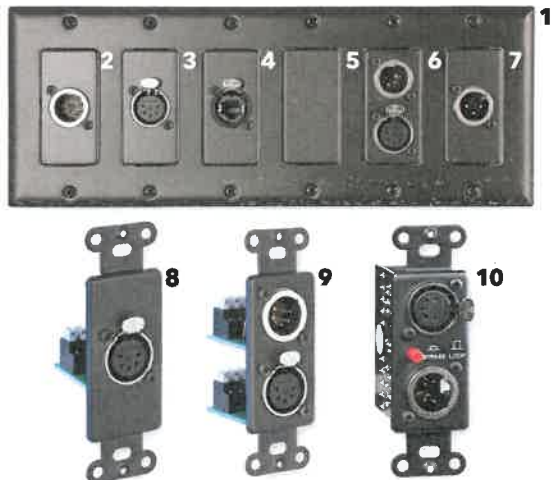

- Models shown:**
1. PWFPG G6 BL
 2. PWINS XLR5M [CSC5/IDC5] BL
 3. PWINS XLR5F [CSC5/IDC5] BL
 4. PWINS RJ45EC [PD/RJ45R] BL
 5. PWINS BLANK NONE BL
 6. PWINS XLR5M 2XLR5F [CSC5/IDC5] [2CSC5/2IDC5] BL
 7. PWINS XLR3M [CSC5/IDC5] BL
 8. PWINS XLR5F IDC5 BL
 9. PWINS XLR5M 2XLR5F IDC5 2IDC5 BL
 10. PWINS XLR5M 2XLR5F PASS CSC5 2CSC5 BL

OVERVIEW

Custom data receptacles that ship from stock.

Specify wall receptacle stations in nearly any configuration: Single receptacle inserts are available in three, four, or five-pin XLR connectors, in both male or female, and female RJ45 etherCON. Dual receptacle inserts are available in many popular configurations.

With pre-installed, locking front connectors and solderless compression-screw or insulation displacement contact (IDC) rear connectors, all inserts are ready for installation out of the box.

Available in attractive matte black, stainless steel and white finishes. Color-matched 1 to 6-gang faceplates (PWFPG [xxxx]) are available separately. All inserts are ordered individually.

Please note that we cannot provide engraving services.

FEATURES

- Receptacle inserts feature pre-installed, rugged, locking-style connectors
- Easy, modular assembly using standard backboxes
- Two-part pluggable connectors with rear compression screw, insulation displacement contact (IDC), or punch-down (RJ45 only) connectors means no soldering
- Field configurable
- Finishes available in matte black, stainless steel or white
- Connectors available optionally without insert plate (PWCON)

WARRANTY

3-year limited warranty. Complete warranty terms located at: <https://www.acuitybrands.com/support/warranty>

NOTE

Actual performance may differ as a result of end-user environment and application. Specifications subject to change without notice.

Notes

1. XLR 3-Pin, 4-Pin and 5-Pin Front Connectors must be paired with either CSC5 or IDC5 Rear Connectors.
2. RJ45 etherCON Front Connectors must be paired with either PD or RJ45R Rear Connectors
3. If ordering a Blank Plate, Rear Connector Type 1 must be NONE. Omit Connector 2 Type and Rear Connector 2 Type Columns.
4. If ordering a single-connector insert (no 2nd connector desired), omit Connector 2 Type and Rear Connector 2 Type Columns.
5. PASS Pass-Thru Insert is a unique part and available only as XLR5M 2XLR5F Front Connectors, and in BL Finish.

ORDERING INFORMATION

PWINS		EXAMPLE (1 Connector): PWINS RJ45EC PD SS EXAMPLE (2 Connectors): PWINS XLR5F 2RJ45EC IDC5 2IDC5 BL										
Series	Connector 1 Type	Connector 2 Type		Pass Thru	Rear Connector 1 Type		Rear Connector 2 Type		Finish			
PWINS Pathway Data Receptacle Inserts	XLR5F ¹	XLR 5-Pin Female	[EMPTY] ⁴	No 2 nd Connector	[EMPTY]	No Pass Thru	CSC5	5-Pin Compression-screw Connector	[EMPTY] ⁴	No 2 nd Rear Connector	BL	Matte Black
	XLR5M ¹	XLR 5-Pin Male	2XLR5F ¹	XLR 5-Pin Female	PASS ⁵	Pass Thru enabled	IDC5	5-Pin Insulation Displacement Contact Connector	2CSC5	5-Pin Compression-screw Connector	SS	Stainless Steel
	XLR3F ¹	XLR 3-Pin Female	2XLR5M ¹	XLR 5-Pin Male			PD	RJ45 Punch Down	2IDC5	5-Pin Insulation Displacement Contact Connector	WH	White
	XLR3M ¹	XLR 3-Pin Male	2XLR3F ¹	XLR 3-Pin Female			RJ45R	RJ45 Female (Rear)	2PD	RJ45 Punch Down		
	XLR4F ¹	XLR 4-Pin Female	2XLR3M ¹	XLR 3-Pin Male			NONE	No Rear Connector; Blank Plate	2RJ45R	RJ45 Female (Rear)		
	XLR4M ¹	XLR 4-Pin Male	2RJ45EC ²	RJ45 etherCON								
	RJ45EC ²	RJ45 etherCON										
	BLANK ³	No connector; Blank Plate										

SPECIFICATIONS

Mechanical

Dimensions	PWINS BLANK NONE	1.3" W x 4" H x 0.2" D (33mm W x 113mm H x 43mm D)
	All other Inserts	1.3" W x 4" H x 1.7" D (33mm W x 113mm H x 5mm D)
Weight	Single-Connector Configuration	1.2 oz (35 g)
	Dual-Connector Configuration	1.9 oz (55 g)
	PWINS BLANK NONE	0.5 oz (15 g)

WIRING

DMX512 / RDM PINOUT		
Purpose	XLR / Terminal Block Pin #	RJ45 PIN # and Wire Color
Shield / Common	1	7 - White / Brown
Data - (complement)	2	2 - Orange
Data + (true)	3	1 - White / Orange
Not Used	4	6 - Green
Not Used	5	3 - White / Green
Not Used - Do Not Connect	N/A	4 - Blue
Not Used - Do Not Connect	N/A	5 - White / Blue
Not Used - Do Not Connect	N/A	8 - Brown

DIMENSIONS

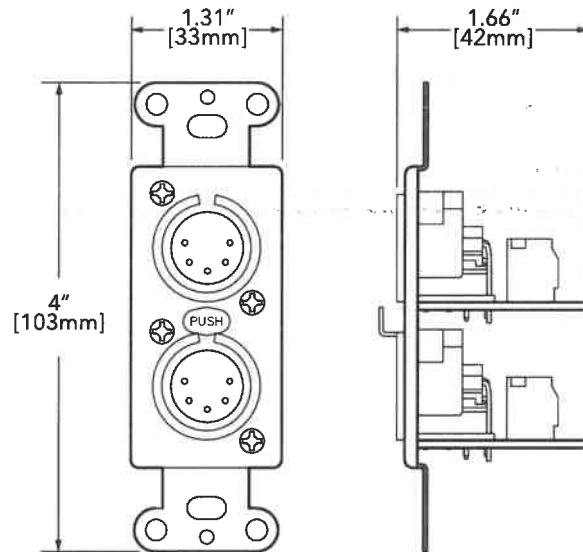

PWINS XLR5M 2XLR5F CSC5 2CSC5 [BL/SS/WH]
Shown.

Appearance will differ depending on
configuration.

REPEATER DIN-MOUNT DMX/RDM OPTO-SPLITTER



Models shown: **1. PWREP DIN P4 NONRDM**
2. PWREP DIN P4 RDM

WARRANTY

3-year limited warranty. Complete warranty terms located at:
<https://www.acuitybrands.com/support/warranty>

NOTE

Actual performance may differ as a result of end-user environment and application. Specifications subject to change without notice.

OVERVIEW

The Pathway DMX Repeater series of opto-splitters are an essential component of DMX distribution systems, permitting star-wiring configurations while isolating and protecting equipment from electrical faults.

The RDM model supports the bi-directional communication standard E1.20 Remote Device Management (RDM).

The Pathway DIN-mount DMX Repeaters provide the same robust features of our Rack-mount 8 port opto-splitters, but in a convenient, more compact, DIN-mountable form factor intended for permanent installs.

FEATURES

- 4 DMX512 Outputs [DMX Only model], or 4 Bi-directional DMX512/RDM Ports [RDM model]
- 1 DMX512 Input, 1 Passive DMX512 Thru [Non RDM model] or Active bi-directional DMX512/RDM Thru [RDM model]
- DMX line termination switch [DMX Only model]
- No fuses - self-resetting port protection recovers from voltage faults
- LED Indicators for Port Activity, Power, DMX Input, and Iso Power
- Data and power easily daisy-chained to other DIN units
- Mounts to standard 35mm DIN rail
- Includes both compression-screw and Insulation Displacement Contact (IDC) terminal block connectors
- Also available in Rack-mount (PWREP RM) and Wall-mount (PWREP WM) form factors, as well as Merger and Hub models available (PWREP DIN [xxxx] RDMHUB)

ORDERING INFORMATION

PWREP		EXAMPLE: PWREP DIN P4 RDM		
PWINS	DIN	P4		
Series	Form Factor	Port Quantity	Model	
PWREP Pathway DMX Repeater	DIN DIN-mount	P4 4 DMX Ports	NONRDM	DMX Only (4.5")
			RDM	E1.20 RDM Compliant (6.25")

Accessories	
PWPWR DIN TERM 50W 24VDC	Power Supply, DIN-mount, Compression Fit Terminal, 50 Watts, 24 Volts DC
PWENC SHELF HOR	DIN System Enclosure, 2-RU Shelf unit with 2x16.5", Horizontal Rails
PWENC SML VER	DIN System Enclosure, Small 10" x 13" x 4.5", Vertical Rails
PWENC MED VER	DIN System Enclosure, Medium 10" x 23" x 4.5", Vertical Rails
PWENC SML HOR	DIN System Enclosure, Small 10" x 13" x 4.5", Horizontal Rails
PWENC MED HOR	DIN System Enclosure, Medium 10" x 23" x 4.5", Horizontal Rails
PWENC LRG VER	DIN System Enclosure, Large 18.5" x 31.5" x 6.25", Vertical Rails
PWCON SPARE IDC5 Q4	Connector, Spare, 5-Pin Insulation Displacement Contact Connector, (Qty 4)
PWCON SPARE CSC5 Q4	Connector, Spare, 5-Pin Compression Screw Connector, (Qty 4)

SPECIFICATIONS

Electrical

Input Ratings 9-36VDC power input
6W maximum power consumption

Isolation & Fault Protection **PWREP DIN P4 NONRDM**
1500V isolation from DMX Input to DMX Outputs
250V fault protection on DMX ports

PWREP DIN P4 RDM
3000V isolation between DMX Ports
(1500V isolation from any DMX port and DMX.Thru)
250V fault protection on DMX ports

Regulatory Compliance CE

Mechanical

Dimensions **PWREP DIN P4 NONRDM**
4.5" W x 4" H x 1.85" D (114mm W x 103mm H x 47mm D)

PWREP DIN P4 RDM
6.25" W x 4" H x 1.85" D (159mm W x 103mm H x 47mm D)

Weight **PWREP DIN P4 NONRDM** 0.5 lbs (0.26 kg)
PWREP DIN P4 RDM 0.7 lbs (0.32 kg)

Environmental

Operating Temperature 14°F to 113°F (-10°C to 45°C)

Relative Humidity 5-95%, non-condensing

Standard Compliance RoHS 2011/65/EU + A1 2015/863

General

Compliance **PWREP DIN P4 NONRDM**
ANSI E1.11 DMX512-A R2013

PWREP DIN P4 RDM
ANSI E1.11 DMX512-A R2013
ANSI E1.20 RDM - Remote Device Management

PART NUMBER CROSS-REFERENCE

PREVIOUS		NEW
Part Number	Catalog Number	Description
1002	PWREP DIN P4 NONRDM	DMX Repeater, DIN-mount, 4-Ports, DMX Only (4.5")
1009	PWREP DIN P4 RDM	DMX Repeater, DIN-mount, 4-Ports, E1.20 RDM Compliant (6.25")

WIRING

DMX512 / RDM PINOUT		
Purpose	XLR / Terminal Block Pin #	RJ45 PIN # and Wire Color
Shield / Common	1	7 - White / Brown
Data - (complement)	2	2 - Orange
Data + (true)	3	1 - White / Orange
Not Used	4	6 - Green
Not Used	5	3 - White / Green
Not Used - Do Not Connect	N/A	4 - Blue
Not Used - Do Not Connect	N/A	5 - White / Blue
Not Used - Do Not Connect	N/A	8 - Brown

DIMENSIONS

PWREP DIN P4 NONRDM

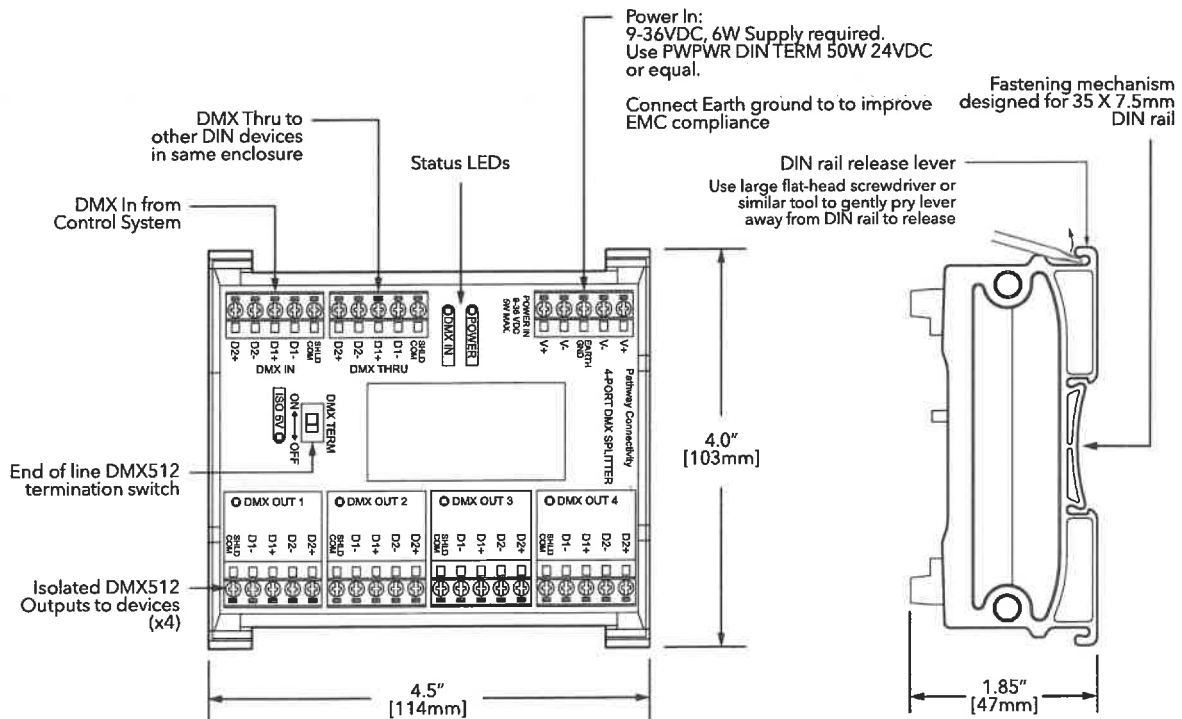

DIMENSIONS

PWREP DIN P4 RDM

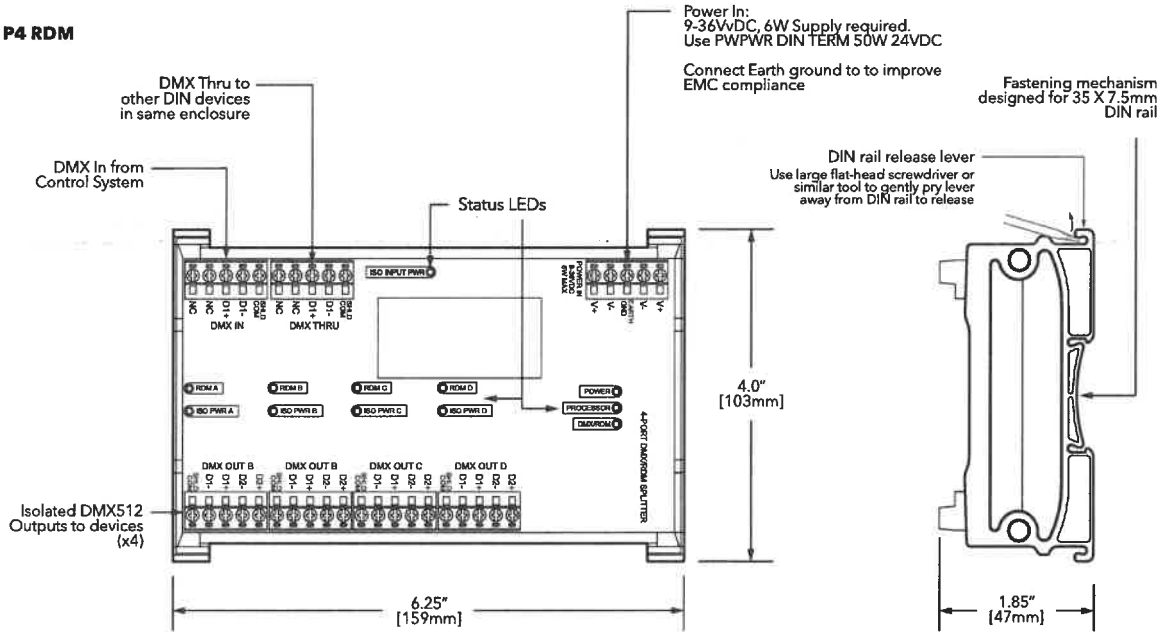

APPLICATION RISER

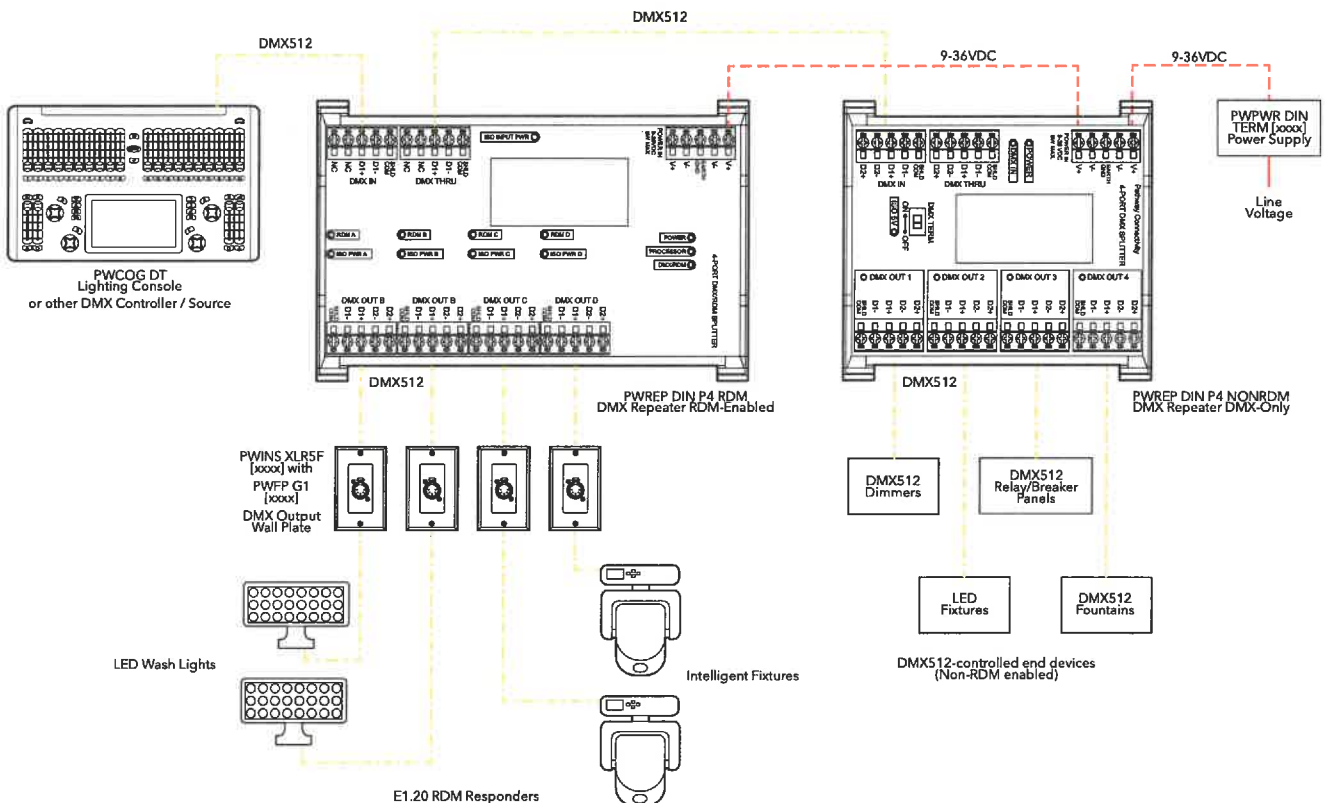

1-6 GANG FACEPLATES

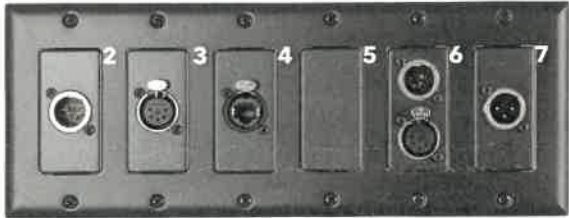

- Models shown:**
1. PWFP G6 BL
 2. PWINS XLR5M [CSC5/IDC5] BL
 3. PWINS XLR5F [CSC5/IDC5] BL
 4. PWINS RJ45EC [PD/RJ45R] BL
 5. PWINS BLANK NONE BL
 6. PWINS XLR5M 2XLR5F [CSC5/IDC5] [2CSC5/2IDC5] BL
 7. PWINS XLR3M [CSC5/IDC5] BL

OVERVIEW

Faceplates are available in 1-Gang through 6-Gang sizes, are made of stainless steel, and are available in three colors: White, Black and Unfinished Stainless Steel. These are ideal for high abuse areas such as backstage.

These will fit any of our Insert products including Vignette & NSB Wall Station Inserts (PWWSI [NPOE/N485] and PWWSI [VPOE/V485]), and XLR and RJ45 Data Receptacles (PWINS [xxxx]).

Please note that we cannot provide engraving services.

FEATURES

- 1-Gang through 6-Gang faceplates
- Constructed of 20 gauge 430 stainless steel
- Finishes available in matte black, stainless steel or white, with supplied matching hardware

WARRANTY

3-year limited warranty. Complete warranty terms located at: <https://www.acuitybrands.com/support/warranty>

NOTE

Actual performance may differ as a result of end-user environment and application. Specifications subject to change without notice.

ORDERING INFORMATION

PWFP		EXAMPLE: PWFP G6 BL	
PWINS			
Series	Width	Finish	
PWFP Pathway Faceplates	G1 1-Gang	BL	Matte Black
	G2 2-Gang	SS	Stainless Steel
	G3 3-Gang	WH	White
	G4 4-Gang		
	G5 5-Gang		
	G6 6-Gang		

SPECIFICATIONS

Mechanical

Dimensions

PWFP G1

2.75" W x 4.5" H x 0.2" D (70mm W x 114mm H x 5mm D)

PWFP G2

4.5" W x 4.5" H x 0.2" D (114mm W x 114mm H x 5mm D)

PWFP G3

6.375" W x 4.5" H x 0.2" D (162mm W x 114mm H x 5mm D)

PWFP G4

8.2" W x 4.5" H x 0.2" D (208mm W x 114mm H x 5mm D)

PWFP G5

10" W x 4.5" H x 0.2" D (254mm W x 114mm H x 5mm D)

PWFP G6

11.8" W x 4.5" H x 0.2" D (300mm W x 114mm H x 5mm D)

Weight

PWFP G1

1.5 oz (43 g)

PWFP G2

2.25 oz (64 g)

PWFP G3

3.2 oz (91 g)

PWFP G4

4 oz (113 g)

PWFP G5

5 oz (141 g)

PWFP G6

5.6 oz (160 g)

PART NUMBER CROSS-REFERENCE

PREVIOUS	NEW	
Part Number	Catalog Number	Description
5001 BL/SS/WH	PWFP G1 [BL/SS/WH]	Faceplate, 1 Gang, [Black/Stainless Steel/White]
5002 BL/SS/WH	PWFP G2 [BL/SS/WH]	Faceplate, 2 Gang, [Black/Stainless Steel/White]
5003 BL/SS/WH	PWFP G3 [BL/SS/WH]	Faceplate, 3 Gang, [Black/Stainless Steel/White]
5004 BL/SS/WH	PWFP G4 [BL/SS/WH]	Faceplate, 4 Gang, [Black/Stainless Steel/White]
5005 BL/SS/WH	PWFP G5 [BL/SS/WH]	Faceplate, 5 Gang, [Black/Stainless Steel/White]
5006 BL/SS/WH	PWFP G6 [BL/SS/WH]	Faceplate, 6 Gang, [Black/Stainless Steel/White]

DIMENSIONS

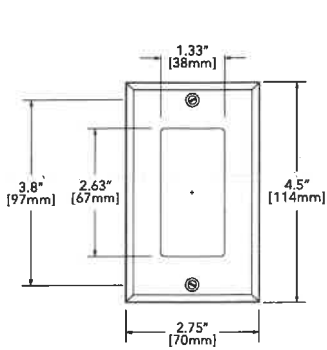

PWFPG1
1 Gang

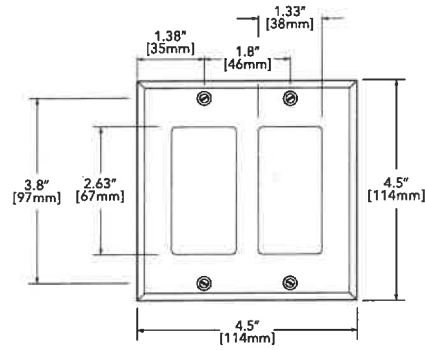

PWFPG2
2 Gang

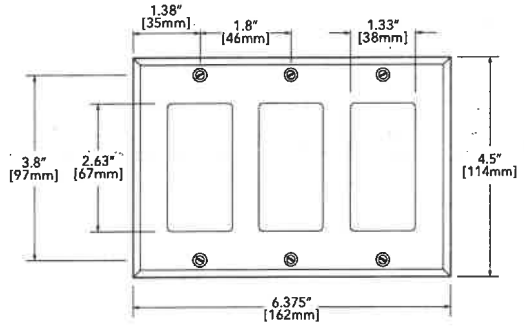

PWFPG3
3 Gang

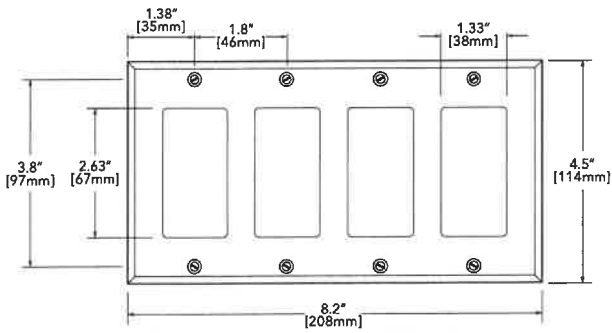

PWFPG4
4 Gang

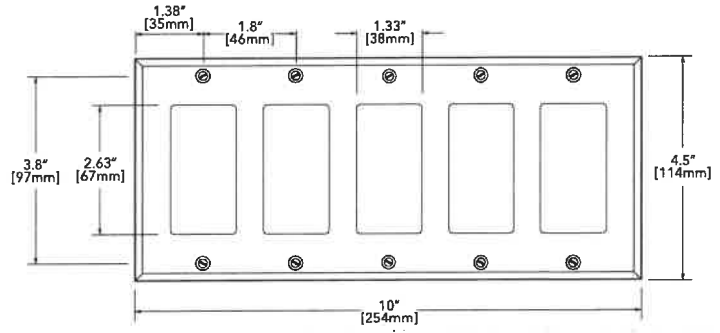

PWFPG5
5 Gang

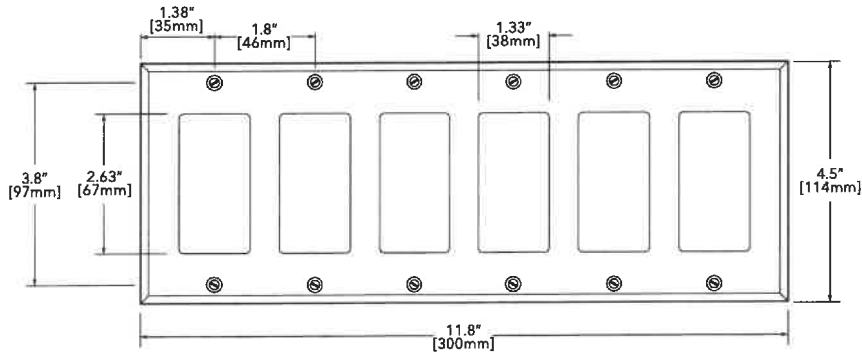

PWFPG6
6 Gang

DIN System Enclosure, Small, Horizontal Rails

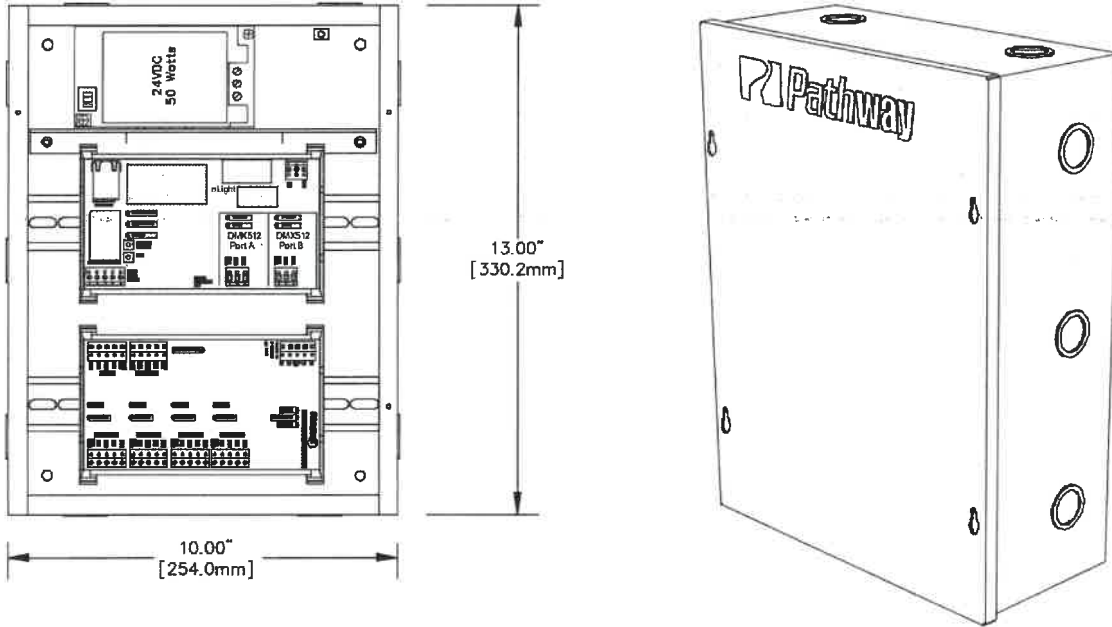

Pre-Assembled Catalog:

PWSA 50W 24VDC SML HOR 1NPWDMX 2REPRDM4

Field Assembly Bill Of Materials:

Catalog:	Description:
PWENC SML HOR	DIN System Enclosure, Small 10" x 13" x 4.5", Horizontal Rails
PWPWR DIN TERM 50W 24VDC	Power Supply, DIN-mount, Compression Fit Terminal, 50 Watts, 24 Volts DC
NPWDMX SNAPSHOT DIN	nLight to Pathway DMX Gateway, DIN-mount, 2-Ports, DMX/sACN Snapshot Controller (6.25")
PWREP DIN P4 RDM	DMX Repeater, DIN-mount, 4-Ports E1.20 RDM Compliant

OVERVIEW

The nLight Relay Panel family delivers cost-effective 0-10V dimming and switching for your building design needs. The panel communicates with an nLight network and supports up to 128 digital devices per nLight control zone. Offering a full range of panel sizes, the nLight Relay Panel is ideal for spaces that require full circuit control, with the optional flexibility of configuring single pole relays into a two or three-pole relays in the field.

Also included on each panel is a programmable input that can be connected to a photocell, for example, and a separate dry contact "alarm" input that overrides all relays until the contact is released.

nLIGHT OPERATION

The nLight Relay Panel is nLight-enabled, meaning it has the ability to communicate over an nLight network. When daisy-chain wired with other nLight-enabled sensors, power packs, or WallPods™ using CAT-5e cabling, an nLight control zone is created. Connecting the panel to an nLight network backbone and nLight® ECLYPSE™ system controller enables time-based control, remote programming and monitoring from SensorView™ software, and BMS integration capabilities.

The digital time clock (DTC) option allows for on-screen configuration and control of connected devices, while introducing scheduling to standalone panel. When connected to nLight backbone and nLight ECLYPSE system controllers the panels relinquish all time clock functionality.

FEATURES

- Communicates with an nLight network
- Up to 128 digital devices per nLight control zone - each nLight Relay Panel utilizes 9 device addresses per 8 relays/dimming outputs:
 - 1 address per relay/dimming output
 - 1 address for the programmable input
- All relays include local manual override lever
- All relays are individually programmable
- One 0-10V dimming output per relay
- Create and control up to 32 schedules – Normal & Holiday (DTC version)
- Astronomical Timeclock feature enables +/- Sunset or Sunrise settings and programmable Latitude/Longitude (DTC version)
- Programmable "dry contact/pull high" input (with provided 24VDC source)
 - Input is programmable to preset/profile scene, photosensor signal, wallpod toggle (maintain or momentary)
- Contact input for "alarm" override (requires maintain contact signal)
- All relays communicate with switch/occupancy/photocell channel 1 out of the box (programmable through SensorView)
- FCR type relays capable of being field configured to 2 and 3-pole relay configurations with included hardware:
 - 4/8 Relay Panel: 2x2-Pole and 1x3-Pole Hardware Included
 - 12/16 Relay Panel: 4x2-Pole and 2x3-Pole Hardware Included
 - 24/32/48 Relay Panel: 6x2-Pole and 3x3-Pole Hardware Included
- Supplies auxiliary 24VDC power and nLight network bus power (40mA per RJ45 port)
- Removable back plate for ease of installation
- UL 924 panel listing for Switching Emergency Circuits
- Optional field installed voltage barrier(s) for normal/emergency use, or mixed voltage use
- Remotely Configurable/Upgradeable

Buy American

This product is assembled in the USA and meets the Buy America(n) government procurement requirements under FAR, DFARS and DOT. Please refer to www.acuitybrands.com/resources/buy-american for additional information.

Warranty

Five-year limited warranty. This is the only warranty provided and no other statements in this specification sheet create any warranty of any kind. All other express and implied warranties are disclaimed. Complete warranty terms located at: www.acuitybrands.com/support/warranty/terms-and-conditions

Note: Actual performance may differ as a result of end-user environment and application. Specifications subject to change without notice.



Relay Panel



ORDERING INFORMATION

nLight RELAY PANEL		Example: ARP INTENC08 NLT 8FCR MVOLT SC SM							
Panel Size		Relay Quantity							
ARP INTENC08 NLT	8-Relay Enclosure	4SPR ¹	4-Single Pole Relays	32SPR ³	32-Single Pole Relays	16FCR ²	16-Field Configurable Relays		
ARP INTENC16 NLT	16-Relay Enclosure	8SPR ¹	8-Single Pole Relays	48SPR ⁴	48-Single Pole Relays	24FCR ³	24-Field Configurable Relays		
ARP INTENC32 NLT	32-Relay Enclosure	12SPR ²	12-Single Pole Relays	4FCR ¹	4-Field Configurable Relays	32FCR ³	32-Field Configurable Relays		
ARP INTENC48 NLT	48-Relay Enclosure	16SPR ²	16-Single Pole Relays	8FCR ¹	8-Field Configurable Relays	48FCR ⁴	48-Field Configurable Relays		
		24SPR ³	24-Single Pole Relays	12FCR ²	12-Field Configurable Relays				
Operating Voltage		Voltage Barrier		Door Type		Mounting		Clock Option	
MVOLT	120-277VAC	[blank]	No barriers	SC	Screw Cover	SM ⁷	Surface Mount	[blank]	No Clock
CNDV ⁵	120-277, 347VAC	1VB	1 Voltage Barrier	HLK ⁷	Hinge Locking	FM	Flush Mount	DTC	Digital Time Clock
		2VB	2 Voltage Barriers						
		3VB ⁶	3 Voltage Barriers						
		4VB ⁶	4 Voltage Barriers						

NOTE: If desired, panel enclosure and interior components can be ordered separately (typically for panel enclosure rough-in prior to final wiring and system programming). Contact your Acuity representative for ordering tree information.

1. Only available in 8-Relay Enclosure.
2. Only available in 16-Relay Enclosure.
3. Only available in 32-Relay Enclosure.
4. Only available in 48-Relay Enclosure.
5. Only available with xFCR Relay Option.
6. Only available in 32 or 48-Relay Enclosure Options.
7. 32/48 Enclosures only available in hinge locking surface mount.

Photosensor Accessories: Order as separate catalog number.

Series	Description	Recommended Application
ARPA PC	Simple switching (at ~1-3fc) with mechanically adjustable slide	Outdoor dusk to dawn, On/Off only
ARPA APS OL	Analog sensor (0-100FC) with switching/dimming thresholds remotely adjustable (via SensorView)	Outdoor dusk to dawn lighting, On/Off or On/Off/Dimming (where necessary)

Additional Accessories: Order as separate catalog number.

Series	Description
ARP FCR CONFIG HARDWARE BAG	Extra set of hardware to create 2 and 3-pole relays in the field (2x 2-pole relays, 1x 3-pole relay)
ARPA FCR40	Replacement FCR40 Relay
ARP BARRIER REPLACEMENT KIT	Additional voltage barrier for 4/8/12/16 relay panels
ARP32-48 VOLTAGE BARRIER	Additional voltage barrier for 24/32/48 relay panels

WIRING - SINGLE-POLE

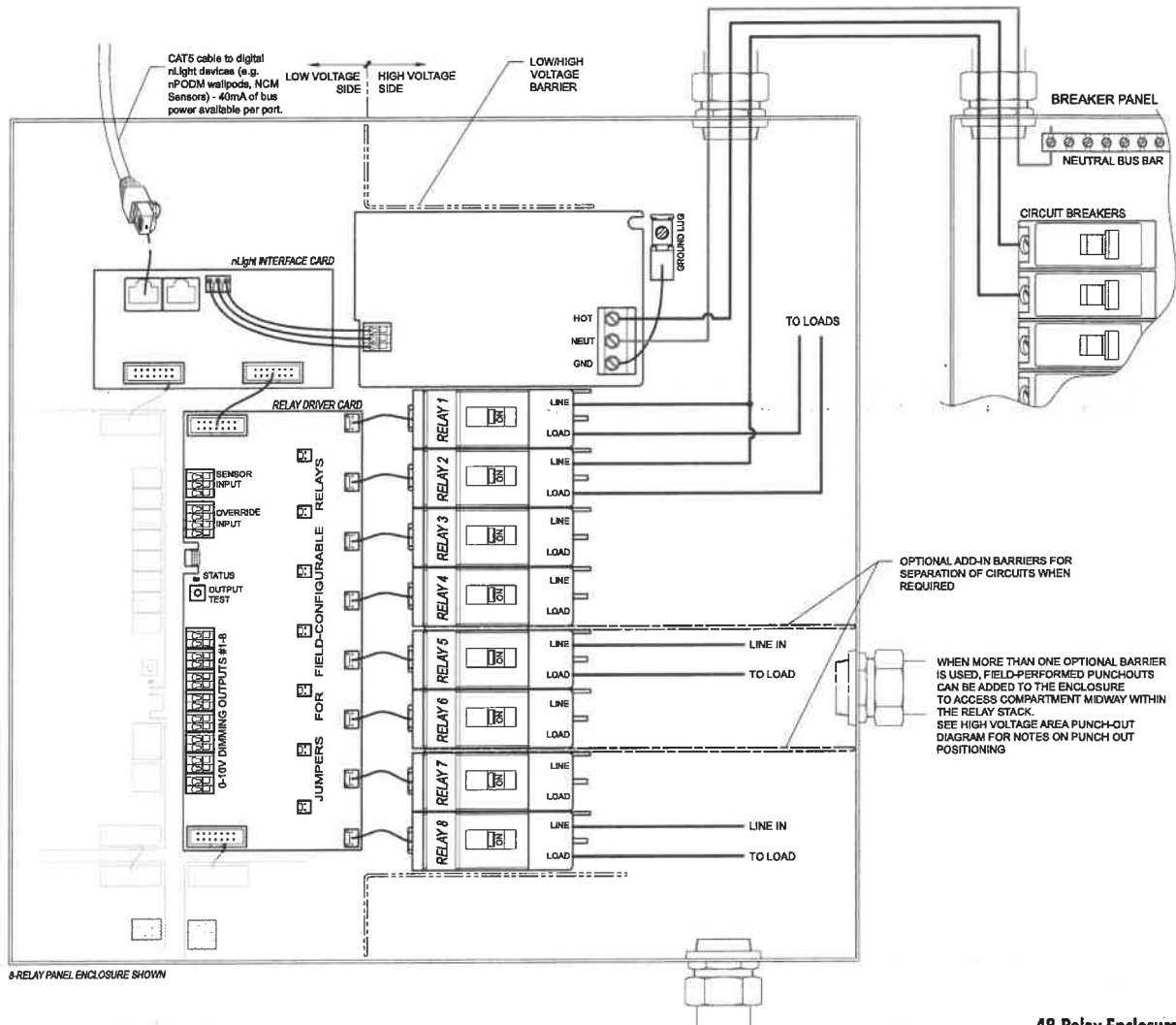

8-RELAY PANEL ENCLOSURE SHOWN



8-Relay Enclosure

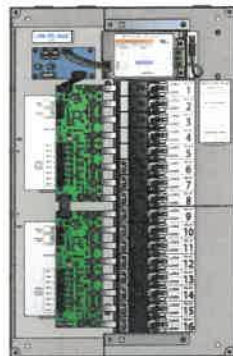

16-Relay Enclosure



32-Relay Enclosure

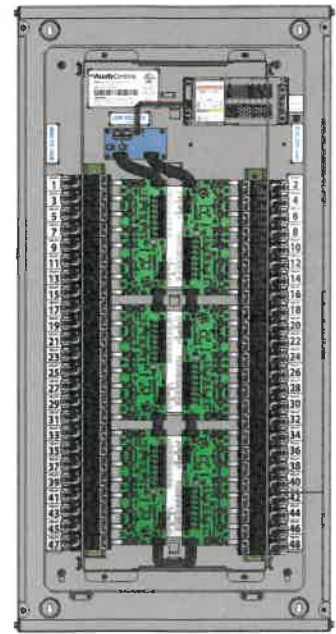

48-Relay Enclosure

Dead-Front removed
Shown with optional Circuit Separation Barrier

SPECIFICATIONS

ENCLOSURE DIMENSIONS

Note: Enclosure is NEMA 1 rated

8-Relay Enclosure

- BACKBOX ONLY: 14.25"H x 14.25"W x 4.00"D
- SURFACE MOUNT SCREW COVER (standard offering): 14.41"H x 14.41"W x 4.05"D
- FLUSH MOUNT SCREW COVER: 15.65"H x 15.65"W x 4.05"D (IN-WALL DEPTH: 4.0")

16 Relay Enclosure

- BACKBOX ONLY: 22.25"H x 14.25"W x 4.00"D
- SURFACE MOUNT SCREW COVER (standard offering): 22.45"H x 14.45"W x 4.06"D
- FLUSH MOUNT SCREW COVER: 23.65"H x 15.65"W x 4.06"D (IN-WALL DEPTH: 4.0")

32 Relay Enclosure

- BACKBOX ONLY: 32.10"H x 20.13"W x 6.00"D
- SURFACE MOUNT HINGED DOOR w/ KEYLOCK: 32.10"H x 20.13"W x 6.68"D

48 Relay Enclosure

- BACKBOX ONLY: 40.10"H x 20.13"W x 6.00"D
- SURFACE MOUNT HINGED DOOR w/ KEYLOCK: 40.10"H x 20.13"W x 6.68"D

Patent

- 10,129,950
- 9,691,578
- 9,368,306

RELAYS

"FCR" Type Relays - Field Configurable for 2-Pole and 3-Pole Relays

- Magnetic/Standard Ballast:
 - 40A @ 120-347VAC (Single-pole)
 - 40A @ 480VAC (Multi-pole)
- Electronic Ballast:
 - 16A @ 120-347VAC
- Tungsten:
 - 20A @ 120-277VAC
- Horsepower Ratings:
 - 2HP @ 120VAC
 - 3HP @ 240-277VAC
- DC:
 - 20A @ 48VDC
- SCCR:
 - 65kA @ 277/480VAC with: Screw Cover (SC) option for 8 & 16 relay enclosure
Hinge Locking (HLK) option for 32 & 48 relay enclosure
 - 14kA @ 277/480VAC with: Hinge Locking (HLK) option for 8 & 16 relay enclosure

"SPR" Type Relays

- Magnetic/Standard Ballast:
 - 20A @ 120-277VAC
- Electronic Ballast:
 - 16A @ 120-277VAC
- Tungsten:
 - 5000W @ 250VAC
- Horsepower Ratings:
 - 2HP @ 120VAC
- DC:
 - 20A @ 48VDC
- SCCR:
 - 5kA @ 277VAC

NLIGHT ADDRESSES PER PANEL

- (9) ARP04/08
 - (8) Relays/Dimming Outputs
 - (1) Programmable Input
- (18) ARP12/16
 - (16) Relays/Dimming Outputs
 - (2) Programmable Inputs
- (36) ARP24/32
 - (32) Relays/Dimming Outputs
 - (4) Programmable Inputs
- (54) ARP48
 - (48) Relays/Dimming Outputs
 - (6) Programmable Inputs

INPUTS (1 PER 8 RELAYS)

- (1) Programmable Input for contact closure or photosensor signal (see photosensor accessories above)
- (1) Override input (requires maintained signal)
- 24VDC/200mA auxiliary power available (per 8 relays)
- Connectors accept 16 to 24 AWG wire

OUTPUTS

- 0-10V Capable of Class 1 or Class 2 Wiring
- 100mA Sink Per Dimming Output
- Note:
 - Low trim default 1V, adjustable down to 0.7V
 - High trim default 10V, 10V max
 - Off mode: < 0.7V
- Connectors accept 16 to 24 AWG wire

POWER SUPPLY INPUTS

- 120-277VAC
- 347VAC Option
- 50/60 Hz
- Max 0.5 Amps for 8/16 relay enclosure
- Max 1.0 Amp for 32/48 relay enclosure

PROGRAMMING

- Via SensorView Software

ENVIRONMENT

- Ambient, 8 & 16 relay enclosure: 32-122F (0-50C)
- Ambient, 32 & 48 relay enclosure: 32-113F (0-45C)
- Relative Humidity: 90% non-condensing

STANDARDS

- UL and cUL 916 listed
- UL 924 listed (for emergency circuit use)
- UL 2043 (Plenum) Rated for Surface Mount Screw cover "SC SM" option (8 & 16 relay enclosure only)

BUS CONNECTOR

- (2) RJ45 connectors
- 40mA Bus Power per RJ45 (80mA total)

9.33



Agenda Item Details

Meeting	Jun 29, 2022 - RSD Regular Board Meeting
Category	9. Consent
Subject	9.33 Approval for Superintendent to receive and approve lowest responsive bid for Playground Structures Site Work at Rio Del Sol, Project No. 22-10L REBID
Access	Public
Type	Action (Consent)
Budget Source	Measure L Funds
Recommended Action	It is recommended that the Board approve the Superintendent to receive and approve the lowest responsible bid for the Playground Structures Site Work at Rio Del Sol, Project No. 22-10L..

Public Content

Speaker:
Wael Saleh, Assistant Superintendent, Business Services

Rationale:

At the January 19, 2022 Board Meeting, the Board approved Rio School District to go to bid for the Procurement of the Playground Equipment at Rio Del Sol. We are now requesting approval for the Superintendent to award the Site Work portion of the playground equipment/structures installation on site at Rio Del Sol K-8 STEAM School. We previously bid the playground structures project which entailed both the supply of play structure equipment and installation including all site work at Rio Del Sol on June 15, 2022 in which no bids were received. The Rio School District reached out to legal counsel for direction due to no bids being received. Legal counsel stated that the Rio School District can now solicit select contractors and move forward with the bid and award of RSD Project 22-10L RE-BID, Rio Del Sol Playground Structure. The playground equipment and installation for this project was previously approved to be awarded by the Superintendent at the January 19, 2022 Regular Board Meeting in which the award is going to Dave Bang & Associates for Concept No. 1.

We request the Board allow the Superintendent to receive and review bids and award the lowest bidder for the site work only.

20220622_MANDATORY REGISTRATION WITH THE DEPARTMENT OF INDUSTRIA.pdf (492 KB)

20220622113327.pdf (234 KB)

Administrative Content

Executive Content

Our adopted rules of Parliamentary Procedure, Robert's Rules, provide for a consent agenda listing several items for approval of the Board by a single motion. Most of the items listed under the consent agenda have gone through Board subcommittee review and recommendation. Documentation concerning these items has been provided to all Board members and the public in advance to assure an extensive and thorough review. Items may be removed from the consent agenda at the request of any board member.

SECTION 00010

NOTICE TO CONTRACTORS CALLING FOR BIDS

NOTICE IS HEREBY GIVEN that Rio School District of Ventura County, California ("District"), acting by and through its Board of Trustees ("Board") will receive at the stated location, up to but not later than the stated time, sealed bids for the award of a contract for the named project, which bids shall then be opened and publicly read aloud.

SCHOOL DISTRICT: Rio School District

PROJECT: Rio Del Sol Steam School Playground Structures RSD (SITE WORK PORTION ONLY-EQUIPMENT SUPPLY & INSTALL BY DISTRICT)

PROJECT NO.: RSD Project #22-10L REBID

MANDATORY PRE-BID JOB WALK: UPON REQUEST Rio Del Sol K-8 STEAM School 3001 N. Ventura Road, Oxnard, Ca. 93036

CONTRACTORS LICENSE CLASSIFICATION: (A) General Engineering & (C27) Landscaping In accordance with the provisions of Business and Professions Code Section 7028.15 and Public Contract Code Section 3300, the District requires that the bidder possess the appropriate license for the work to be performed at the time the bid is submitted. Appropriate licenses are noted above; more than one license may be required. This list in no way relieves the contractor from fulfillment of any legal requirement or licensing necessary for performance of its work.

TIME, DATE & PLACE TO SUBMIT BIDS: Bids must be received not later than **TO BE DETERMINED BY DISTRICT**, at the Rio School District administrative offices, 1800 Solar, 3rd Floor, Oxnard, CA 93036.

OBTAIN/EXAMINE DOCUMENTS: Plans may be obtained after **June 27TH, 2022**, by contacting the District Representative, Balfour Beatty, at (805)266-0671 or via email at KHenderson@balfourbeattyus.com or Ftrevino@Balfourbeattyus.com. Plans will be distributed electronically by Balfour Beatty. Plan holders are responsible for all fees associated with the reproduction of documents pertaining to the Project, including original plan set, addenda and any shipping costs.

PREVAILING WAGES: The Department of Industrial Relations, State of California ("DIR"), has determined the general prevailing rates of per diem wages applicable to this work, including holiday and overtime work and employer payments for health and welfare, pension, vacation and similar purposes. The DIR's schedule of rates is available on the Internet at http://www.dir.ca.gov/OPRL/statistics_and_databases.html or through the Business Services Department of the Rio School District, 1800 Solar, 3rd Floor, Oxnard, California 93036, and will be made available to any interested party upon request.

MANDATORY REGISTRATION WITH THE DEPARTMENT OF INDUSTRIAL RELATIONS: Senate Bill 854 requires ALL contractors/subcontractors submitting bids on public works projects to be registered with the DIR for purposes of labor compliance. No bid will be accepted by the District from any contractor/subcontractor who is not registered with the DIR at the time the bid is submitted. Any bidding contractor/subcontractor submitting a bid without being registered with the

DIR at the time of bid will have their bid rejected as being non-responsive. **Bidding contractors and subcontractors must submit proof of DIR registration with their bid.**

PLEASE BE ADVISED, this project is estimated to exceed **\$25,000, or \$15,000** for alteration, demolition, repair or maintenance, and, therefore, is subject to the DIR compliance monitoring and enforcement requirements set forth in California Code of Regulations, Title 8, Chapter 8, Subchapter 4.5. (See also Cal. Labor Code § 1771.5.) Therefore, the contractor and all subcontractors for this project must furnish certified payroll records to the DIR's Compliance Monitoring Unit at least monthly, or within ten (10) days of any separate request by the Compliance Monitoring Unit, in the manner required by the Compliance Monitoring Unit.

REQUIRED FORMS: All bidding contractors must submit the following items with their bid:

1. 00210 Bid Form
2. 00215 Designation of Subcontractors
3. 00218 Contractors Registration Certification (DIR)
4. 00220 Non-Collusion Affidavit
5. 00222 Certification of Prevailing Wage
6. 00230 Contractor's Statement of Experience
7. 00240 Acknowledgment of Bidding Practices Regarding Indemnity
8. 00300 Bid Bond

All forms must be filled in completely, signed and returned with bid. Contract award will be based on lowest responsive and responsible bidder. The Board reserves the right to reject any and all bids to waive any irregularities or informalities in any bids or in the bidding process.

INQUIRIES:

For further information contact:

Rio School District
Wael Saleh, Asst. Superintendent of Business Services
(805) 485-3111

or

Balfour Beatty Construction
Keith Henderson, Senior Project Manager/District Representative
(805) 616-8552

TO BE PUBLISHED: NOT APPLICABLE DUE TO REBID FROM NO PREVIOUS RESPONSE TO PUBLIC ADVERTISEMENT AND REQUEST TO BID. NO CONTRACTORS RESPONDED, REBID.

END OF SECTION



Agenda Item Details

Meeting	Jan 19, 2022 - RSD Regular Board Meeting
Category	9. Discussion/Action
Subject	9.3 Approval to Bid Rio del Sol Playground Equipment and Authorize the Superintendent to Award Bids
Access	Public
Type	Action
Budgeted	Yes
Budget Source	CFD funds
Recommended Action	It is recommended that the Board Approve the District to go out to Bid for the Rio del Sol Playground Equipment and Authorize the Superintendent to Award Bid.

Public Content

Speaker: Wael Saleh, Assistant Superintendent of Business Services, Veronica Rauschenberger, Director of School and Systems Improvement, and Dr. Ryan Emery, Principal, Rio del Sol School

Rationale:

Rio Del Sol currently does not have a playground on campus. Rio Del Sol formed a committee, consisting of parents, staff, and site administration, who met in November 2021 to look over concept ideas from local vendors. A presentation of design concepts was shared and discussed at the November 10, 2021 meeting. The general consensus is that the Rio del Sol community prefers concept 1 with concept 2 being a secondary option. Both concepts are attached.

Consensus:

The committee liked both proposals but there was a clear preference to the design of concept 1 (attached). The team discussed and liked the layout, structure, and design and felt that it was 'kid friendly' and brought in the natural element of Rio del Sol.

The approximate cost for Concept 1 is \$315,000 plus soft costs, and the approximate cost for Concept 2 is \$220,000 plus soft costs.

[9.4 Attachment.pdf \(875 KB\)](#)

Administrative Content

Executive Content

Motion & Voting

It is recommended that the Board Approve the District to go out to Bid for the Rio del Sol Playground Equipment both options and bring bids to the Governing Board for final approval.

Motion by Eleanor Torres, second by Linda Armas.

Final Resolution: Motion Carries

Yes: Eleanor Torres, Linda Armas, Kristine Anderson

9.33



Agenda Item Details

Meeting	Jun 29, 2022 - RSD Regular Board Meeting
Category	9. Consent
Subject	Approval of the Contract Renewal with Hip Hop Mindset FY 2022/2023
Access	Public
Type	Action (Consent)
Fiscal Impact	Yes
Dollar Amount	52,900.00
Budget Source	LCAP
Recommended Action	Staff recommends approval of the contract renewal with HipHop Mindset FY 2022/2023

Public Content

Speaker: John Puglisi, Superintendent

Rationale:

Hip Hop Mindset will continue to provide the students with dance classes at all sites.

[HipHop2223.pdf \(349 KB\)](#)

Administrative Content

Executive Content

Our adopted rules of Parliamentary Procedure, Robert's Rules, provide for a consent agenda listing several items for approval of the Board by a single motion. Most of the items listed under the consent agenda have gone through Board subcommittee review and recommendation. Documentation concerning these items has been provided to all Board members and the public in advance to assure an extensive and thorough review. Items may be removed from the consent agenda at the request of any board member.



SHORT FORM SERVICES AGREEMENT

This Agreement is intended to be used for low cost, low risk, short-term services.

This Services Agreement (the "Agreement") is made and entered into this 15 day of June 2022 by and between Rio School District (hereinafter referred to as "District") and Hip Hop Mindset, (hereinafter referred to as "Provider.")

Hip Hop Mindset
 Provider _____ Telephone Number _____

 Street Address _____ Fax Number _____

 City, State, Zip code _____ E-mail Address _____

 Tax Identification or Social Security Number _____ Business License Number (if applicable) _____

SERVICES

Dance Instruction, Production, Dance Showcases

Description of Services

<u>August 2022 - June 2023</u>	<u>8:00AM - 3:00pm</u>	<u>Rio School District School Sites</u>
Date(s) of Service	Hour(s) of Service	Location

FEES

- Compensation for Services \$52,990.00
- Other Ancillary Cost, as applicable \$ _____
- Total not to Exceed \$ _____
- W-9 received

PAYMENT. District will pay Provider after receipt of an invoice, net 30 days.

CONDITIONS. Provider will have no obligation to provide services until District returns a signed copy of this Agreement.

NATURE OF RELATIONSHIP. The parties agree the relationship created by this Agreement is that of independent contractor.

AUTHORITY. Provider represents and warrants that Provider has all requisite power and authority to conduct its business and to execute, deliver, and perform this Agreement.

BINDING EFFECT. This Agreement shall inure to the benefit and shall be binding upon all of the parties to this Agreement, and their respective successors in interest or assigns.

TERMINATION OR AMENDMENT. This Agreement may be terminated or amended in writing at any time by mutual written consent of all of the parties to this Agreement, and may be terminated by either party for any reason by giving the other party 30 days advance written notice.

NON-DISCRIMINATION AND EQUAL EMPLOYMENT OPPORTUNITY. Provider represents and agrees that it does not and shall not discriminate against any employee or applicant for employment because of race, religion, color, sex, or national origin.

GOVERNING LAW AND VENUES. This Agreement shall be interpreted in accordance with the laws of the State of California. If any action is brought to interpret or enforce any term of this Agreement, the action shall be brought in state or federal court situated in the County of Ventura, State of California.

ARBITRATION. Any dispute arising under this Agreement, including, without limitation, all disputes relating in any manner to the performance or enforcement of this Agreement shall be resolved by binding arbitration in Ventura County pursuant to the rules of the American Arbitration Association.

ATTORNEYS FEES. In the event of any action or proceeding to interpret or enforce the terms of this Agreement, the prevailing party, as determined by the court or arbitrator, shall be entitled to recover its reasonable attorneys fees and costs incurred in connection with such actions or proceeding.

INDEMNIFICATION. Provider agrees to defend, indemnify, and hold harmless District, its officers, agents, employees, and/or volunteers from any and all claims, demands, losses, damages and expenses, including legal fees and costs, or other obligations or claims arising out of any liability or damage to person or property, or any other loss, sustained or claimed to have been sustained arising out of activities of the Provider or those of any of its officers, agents, employees, or subcontractors of Provider, whether such act or omission is authorized by this Agreement or not. Provider shall also pay for any and all damage to the Real and Personal Property of the District, or loss or theft of such Property, done or caused by such persons. District assumes no responsibility whatsoever for any property placed on District premises by Provider, Provider's agents, employees or subcontractors. Provider further hereby waives any and all rights of subrogation that it may have against the District. The provisions of this Agreement do not apply to any damage or losses caused solely by the negligence of the District or any of its officers, agents, employees, and/or volunteers.

INSURANCE. Provider, at its own cost and expense, shall procure and maintain during the term of this Agreement, policies of insurance for the following types of coverage:

- **Workers' Compensation Insurance.** Provider shall procure and maintain, during the term of this Agreement, Workers' Compensation Insurance, as required by California law, on all of its employees engaged in work related to the performance of this Agreement. In the case of any activities which are hired or subcontracted, Provider shall require all vendors and subcontractors to provide Workers' Compensation Insurance for all of the vendor's and/or subcontractor's employees to be engaged in such activities unless such employees are covered by the protection afforded by the Provider's Workers' Compensation Insurance.
- **Commercial General Liability Insurance.** Provider shall procure and maintain, during the term of this Agreement, not less than the following General Liability Insurance coverage in the amounts of \$1,000,000 per occurrence and \$2,000,000 aggregate.

Commercial General Liability insurance shall include products/completed operations, broad form property damage, and personal and advertising injury coverage.

Any and all vendors and subcontractors hired by Provider in connection with the activities described in this Agreement shall maintain such insurance unless the Provider's insurance covers the subcontractor and its employees.

- **Automobile Liability.** If vehicles will be driven on district property, Provider shall procure and maintain, during the full term of this Agreement following Automobile Liability Insurance with the following minimum coverage limits:
 - Personal vehicles: \$500,000.00 combined single limit or
\$100,000.00 per person / \$300,000.00 per accident
 - Commercial vehicles: \$1,000,000.00 combined single limit
- **Other Coverage as Dictated by the District.** Provider shall procure and maintain, during the term of this Agreement, Abuse and Molestation coverage in the amounts of \$1,000,000 per occurrence and \$2,000,000 aggregate.

Certificates of Insurance. Provider and any and all vendors and subcontractors working for Provider shall provide certificates of insurance to the District as evidence of the insurance coverage required herein, not less than 15 days prior to commencing the proposed activity, and at any other time upon the request of the District. Certificates of such insurance shall be filed with the District on or before commencement of the services under this Agreement.

Provider's and any and all Provider subcontractor's Commercial General Liability insurance and Abuse and Molestation coverage shall name the District, its employees, and school board members as additional insureds.

Insurance written on a "claims made" basis is to be renewed by the Provider and all Provider subcontractors for a period of three (3) years following termination of this Agreement. Such insurance must have the same coverage and

limits as the policy that was in effect during the term of this agreement, and will cover the Provider for all the claims made.

Failure to Procure Insurance. Failure on the part of Provider, or any of its subcontractors, to procure or maintain required insurance shall constitute a material breach of contract under which the District may immediately terminate this agreement.

ACKNOWLEDGEMENT AND AGREEMENT

I have read this agreement and agree to its terms

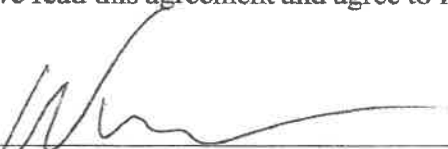

Provider Signature

06/15/2022

Date

SITE AGREEMENT

Site Administrator Signature

Date

DISTRICT APPROVAL

District Administrator Signature

Date

