



## Project Manual

# Asbestos Abatement Specification

Roosevelt Middle School

680 E. 24<sup>th</sup> Avenue  
Eugene, Oregon 97405

Eugene School District 4J

**Faxed or Electronically Submitted Quotes Will Not Be Accepted**

January 2016  
Project No. 410.566.001

**DOCUMENT 00 01 01**  
**TITLE PAGE**

**PROJECT MANUAL:**

Roosevelt Middle School  
680 E. 24<sup>th</sup> Avenue  
Eugene, Oregon 97405  
C.I.P. Project No. 410.566.001

**OWNER:**

Eugene School District 4J  
715 West 4<sup>th</sup> Ave.  
Eugene, Oregon 97402  
Project Manager: Douglas Lemonds  
(541) 790-7432 Office  
lemonds@4j.lane.edu

**ENVIRONMENTAL CONSULTANT:**

PBS Engineering + Environmental  
2645 Willamette Street, Suite A  
Eugene, Oregon 97405  
Project Manager: Jeff Heeren  
EPA Accredited Project Designer  
Accreditation #: PDR-15-4941A  
(541) 686-8684 Office  
jeff.heeren@pbsenv.com

**DATE:** January 2016

**DOCUMENT 00 01 10**  
**PROJECT MANUAL TABLE OF CONTENTS**  
Roosevelt Middle School  
410.566.001  
January 2016

The following is a list of all Divisions, Sections, and Drawings which are included in the Project Manual

<b>INTRODUCTORY PAGES</b>	<b>PAGES</b>
Cover Page	1
Document 00 01 01 Title Page	1
Document 00 01 10 Table of Contents	2

<b>DIVISION 00 BIDDING AND CONTRACT REQUIREMENTS</b>	
Document 00 11 13 Invitation To Bid	1
Document 00 21 13 Instructions to Bidders, AIA Document A701	7
Document 00 22 13 Supplementary Instructions to Bidders	5
Document 00 41 13 Bid Form	4
Document 00 45 22 First Tier Subcontractor Disclosure Form	1
Document 00 52 13 Form of Agreement, AIA Form A101	1
Document 00 72 13 General Conditions, AIA Document A201	41
Document 00 73 00 Supplementary Conditions	15
Document 00 73 43 Prevailing Wage Rates for Public Contracts in Oregon Effective January 1, 2016	1

<b>DIVISION 01 GENERAL REQUIREMENTS</b>	
Section 01 11 00 Summary of Work	9
Section 01 25 00 Contract Modification Procedures (CR/PO Form)	4
Section 01 29 00 Payment Procedures	3
Section 01 31 00 Project Management and Coordination	8
Section 01 33 00 Submittal Procedures	3
Section 01 40 00 Quality Requirements	4
Section 01 50 00 Temporary Facilities and Controls	7
Section 01 60 00 Product Requirements (Substitution Request Form)	5
Section 01 73 00 Execution Requirements	7
Section 01 73 29 Cutting and Patching	4
Section 01 77 00 Closeout Procedures	5

<b>DIVISION 02 TECHNICAL SPECIFICATIONS</b>	
Section 02 20 80 Asbestos Abatement Procedures	12

<b>DRAWINGS ASBESTOS ABATEMENT</b>	
HM 1 Abatement Phasing Plan	
HM 2 Phase 1 Part 1 Flooring Materials Abatement Plan	
HM 3 Phase 1 Part 2 Flooring Materials Abatement Plan	
HM 4 Phase 1 Part 1 Thermal System Insulation Abatement Plan	
HM 5 Phase 1 Part 2 Thermal System Insulation Abatement Plan	
HM 6 Phase 1 Part 1 Miscellaneous Materials Abatement Plan	
HM 7 Phase 1 Part 2 Miscellaneous Materials Abatement Plan	

HM 8	Phase 1 Part 1 Roofing Materials Abatement Plan
HM 9	Phase 1 Part 2 Roofing Materials Abatement Plan



**DOCUMENT 00 11 13**  
**INVITATION TO BID**

Sealed bids will be received by Kathi Hernandez, Facilities Management Assistant, for the Roosevelt Middle School Asbestos Abatement project on February 4, 2016 until the Deadline for Bid Submission at 2:00 pm, at the Eugene School District 4J Facilities Management Office, 715 West Fourth Avenue, Eugene, Oregon 97402. The Bids will be opened publicly and read aloud immediately after the deadline for submission of bids. Late Bids will not be considered.

Briefly, the work is described as removal and disposal of all asbestos-containing materials and mercury vapor light tubes at Roosevelt Middle School. This project is scheduled to be performed in one mobilization. The asbestos-containing building materials scheduled for removal include; vinyl floor tile and mastic, sheet vinyl flooring, pipe insulation, gypsum board walls and ceilings, cement asbestos products, window glazing compound, roofing materials and other miscellaneous asbestos containing materials.

Beginning January 14, 2016 Prime Bidders, Sub-bidders and Suppliers may obtain bidding documents at the following hyperlink: <http://www.4j.lane.edu/bids/>. Hard copies are not provided by the School District. It is the responsibility of all Prime Bidders, Sub-bidders, and Suppliers to obtain Bidding Documents and all Addenda from the hyperlink.

Bidders and Suppliers may also obtain bidding documents from Central Print and Reprographic Services, 45 West 5th Ave, Eugene, Oregon, by paying the cost of reproduction. It is the responsibility of those obtaining Bidding Documents in this manner to obtain any and all addenda from the hyperlink or the Plan Centers.

Bidding Documents may be examined at the following locations:

- Eugene Builder's Exchange, 2460 W. 11th, Eugene, OR 97402
- Central Oregon Builders Exchange, 1902 NE 4<sup>th</sup> Street, Bend, OR 97701
- McGraw Hill Construction, 3461 NW Yeon Ave., Portland, OR 97210
- Daily Journal of Commerce Plan Center, 921 S.W. Washington St., Ste 210, Portland, OR 97205-2810
- Douglas County Plan Center, 3076 NE Diamond Lake Blvd, Roseburg, OR 97470
- Oregon Contractor Plan Center, 5468 SE International Way, Milwaukie, OR 97222
- Reed Construction Data, 30 Technology Parkway South, Ste 500, Norcross, GA 90092
- Salem Contractor's Exchange, 2256 Judson Street SE, Salem, OR 97309
- Willamette Valley Bid Center, 33862 SE Eastgate Circle, Corvallis, OR 97333

A mandatory pre-bid conference and walk-through has been scheduled for January 18, 2016, at 10:30 am. The location of the conference will be at Roosevelt Middle School located at 680 E. 24<sup>th</sup> Avenue, Eugene, Oregon. All Prime Bidders wishing to submit a bid are required to attend this conference. Statements made by the District's representatives at the conference are not binding upon the District unless confirmed by Written Addendum. Pre-qualification of bidders is not required.

Each Bid must be submitted on the prescribed form and accompanied by a Surety Bond, Cashiers Check, or Certified Check, executed in favor of Eugene School District 4J, in the amount not less than ten percent (10%) of the total bid, based upon the total bid amount for those items bid upon.

Either with the Bid or within two working hours of the Deadline for Submission of Bids, bidders shall submit, on the form provided, information first-tier subcontractors furnishing labor or labor and materials, as provided in ORS 279C.370. Bids for which disclosure forms are required, but not submitted, will be rejected.

No bid for a construction contract will be received or considered unless the Bidder is registered with the Construction Contractors Board or licensed by the State Landscape Contractors Board at the time the Bid is made, as required by OAR 137-049-0230. A license to work with asbestos-containing materials under ORS 468A.720 is required for this project.

For every bid \$100,000 or greater, all Contractors and Subcontractors shall have a public works bond, in the amount of \$30,000, filed with the Construction Contractors' Board (CCB), before starting work on the project, unless exempt. A copy of the Contractor' BOLI Public Works Bond shall be provided with the executed contract documents.

Each Bid shall contain a statement indicating whether the Bidder is a "resident bidder", as defined in ORS 279A.120.

Each Bid shall contain a statement that the "Contractor agrees to be bound by and will comply with the provisions of ORS 279C.800 through 279C.870 regarding payment of Prevailing Wages".

## INVITATION TO BID – SECTION 01 11 13

Contractor shall certify nondiscrimination in obtaining required subcontractors, in accordance with ORS 279A.110(4).

Eugene School District 4J reserves the right to (1) reject any or all Bids not in compliance with all public bidding procedures and requirements, (2) postpone award of the Contract for a period not to exceed sixty (60) days from the date of bid opening, (3) waive informalities in the Bids, and (4) select the Bid which appears to be in the best interest of the District.

Date: January 12, 2016

By: Kathi Hernandez, Facilities Management Assistant

Published: Register Guard, Daily Journal of Commerce, ORPIN (Oregon Procurement Information Network)

Posted: Eugene School District 4J Administration Office  
200 North Monroe  
Eugene, OR 97402

**DOCUMENT 00 21 13**  
**INSTRUCTIONS TO BIDDERS**

**PART 1 GENERAL**

**STANDARD FORM**

Instructions to Bidders - AIA Document A701, 1997 Edition, immediately following are part of this Project Manual.

END OF DOCUMENT 00 21 13

# AIA<sup>®</sup> Document A701<sup>™</sup> – 1997

## *Instructions to Bidders*

for the following PROJECT:

*(Name and location or address)*

THE OWNER:

*(Name, legal status and address)*

THE ARCHITECT:

*(Name, legal status and address)*

### TABLE OF ARTICLES

1	DEFINITIONS
2	BIDDER'S REPRESENTATIONS
3	BIDDING DOCUMENTS
4	BIDDING PROCEDURES
5	CONSIDERATION OF BIDS
6	POST-BID INFORMATION
7	PERFORMANCE BOND AND PAYMENT BOND
8	FORM OF AGREEMENT BETWEEN OWNER AND CONTRACTOR

### ADDITIONS AND DELETIONS:

The author of this document has added information needed for its completion. The author may also have revised the text of the original AIA standard form. An *Additions and Deletions Report* that notes added information as well as revisions to the standard form text is available from the author and should be reviewed. A vertical line in the left margin of this document indicates where the author has added necessary information and where the author has added to or deleted from the original AIA text.

This document has important legal consequences. Consultation with an attorney is encouraged with respect to its completion or modification.



## ARTICLE 1 DEFINITIONS

§ 1.1 Bidding Documents include the Bidding Requirements and the proposed Contract Documents. The Bidding Requirements consist of the Advertisement or Invitation to Bid, Instructions to Bidders, Supplementary Instructions to Bidders, the bid form, and other sample bidding and contract forms. The proposed Contract Documents consist of the form of Agreement between the Owner and Contractor, Conditions of the Contract (General, Supplementary and other Conditions), Drawings, Specifications and all Addenda issued prior to execution of the Contract.

§ 1.2 Definitions set forth in the General Conditions of the Contract for Construction, AIA Document A201, or in other Contract Documents are applicable to the Bidding Documents.

§ 1.3 Addenda are written or graphic instruments issued by the Architect prior to the execution of the Contract which modify or interpret the Bidding Documents by additions, deletions, clarifications or corrections.

§ 1.4 A Bid is a complete and properly executed proposal to do the Work for the sums stipulated therein, submitted in accordance with the Bidding Documents.

§ 1.5 The Base Bid is the sum stated in the Bid for which the Bidder offers to perform the Work described in the Bidding Documents as the base, to which Work may be added or from which Work may be deleted for sums stated in Alternate Bids.

§ 1.6 An Alternate Bid (or Alternate) is an amount stated in the Bid to be added to or deducted from the amount of the Base Bid if the corresponding change in the Work, as described in the Bidding Documents, is accepted.

§ 1.7 A Unit Price is an amount stated in the Bid as a price per unit of measurement for materials, equipment or services or a portion of the Work as described in the Bidding Documents.

§ 1.8 A Bidder is a person or entity who submits a Bid and who meets the requirements set forth in the Bidding Documents.

§ 1.9 A Sub-bidder is a person or entity who submits a bid to a Bidder for materials, equipment or labor for a portion of the Work.

## ARTICLE 2 BIDDER'S REPRESENTATIONS

§ 2.1 The Bidder by making a Bid represents that:

§ 2.1.1 The Bidder has read and understands the Bidding Documents or Contract Documents, to the extent that such documentation relates to the Work for which the Bid is submitted, and for other portions of the Project, if any, being bid concurrently or presently under construction.

§ 2.1.2 The Bid is made in compliance with the Bidding Documents.

§ 2.1.3 The Bidder has visited the site, become familiar with local conditions under which the Work is to be performed and has correlated the Bidder's personal observations with the requirements of the proposed Contract Documents.

§ 2.1.4 The Bid is based upon the materials, equipment and systems required by the Bidding Documents without exception.

## ARTICLE 3 BIDDING DOCUMENTS

### § 3.1 COPIES

§ 3.1.1 Bidders may obtain complete sets of the Bidding Documents from the issuing office designated in the Advertisement or Invitation to Bid in the number and for the deposit sum, if any, stated therein. The deposit will be refunded to Bidders who submit a bona fide Bid and return the Bidding Documents in good condition within ten days after receipt of Bids. The cost of replacement of missing or damaged documents will be deducted from the deposit. A Bidder receiving a Contract award may retain the Bidding Documents and the Bidder's deposit will be refunded.

§ 3.1.2 Bidding Documents will not be issued directly to Sub-bidders unless specifically offered in the Advertisement or Invitation to Bid, or in supplementary instructions to bidders.



§ 3.1.3 Bidders shall use complete sets of Bidding Documents in preparing Bids; neither the Owner nor Architect assumes responsibility for errors or misinterpretations resulting from the use of incomplete sets of Bidding Documents.

§ 3.1.4 The Owner and Architect may make copies of the Bidding Documents available on the above terms for the purpose of obtaining Bids on the Work. No license or grant of use is conferred by issuance of copies of the Bidding Documents.

### § 3.2 INTERPRETATION OR CORRECTION OF BIDDING DOCUMENTS

§ 3.2.1 The Bidder shall carefully study and compare the Bidding Documents with each other, and with other work being bid concurrently or presently under construction to the extent that it relates to the Work for which the Bid is submitted, shall examine the site and local conditions, and shall at once report to the Architect errors, inconsistencies or ambiguities discovered.

§ 3.2.2 Bidders and Sub-bidders requiring clarification or interpretation of the Bidding Documents shall make a written request which shall reach the Architect at least seven days prior to the date for receipt of Bids.

§ 3.2.3 Interpretations, corrections and changes of the Bidding Documents will be made by Addendum. Interpretations, corrections and changes of the Bidding Documents made in any other manner will not be binding, and Bidders shall not rely upon them.

### § 3.3 SUBSTITUTIONS

§ 3.3.1 The materials, products and equipment described in the Bidding Documents establish a standard of required function, dimension, appearance and quality to be met by any proposed substitution.

§ 3.3.2 No substitution will be considered prior to receipt of Bids unless written request for approval has been received by the Architect at least ten days prior to the date for receipt of Bids. Such requests shall include the name of the material or equipment for which it is to be substituted and a complete description of the proposed substitution including drawings, performance and test data, and other information necessary for an evaluation. A statement setting forth changes in other materials, equipment or other portions of the Work, including changes in the work of other contracts that incorporation of the proposed substitution would require, shall be included. The burden of proof of the merit of the proposed substitution is upon the proposer. The Architect's decision of approval or disapproval of a proposed substitution shall be final.

§ 3.3.3 If the Architect approves a proposed substitution prior to receipt of Bids, such approval will be set forth in an Addendum. Bidders shall not rely upon approvals made in any other manner.

§ 3.3.4 No substitutions will be considered after the Contract award unless specifically provided for in the Contract Documents.

### § 3.4 ADDENDA

§ 3.4.1 Addenda will be transmitted to all who are known by the issuing office to have received a complete set of Bidding Documents.

§ 3.4.2 Copies of Addenda will be made available for inspection wherever Bidding Documents are on file for that purpose.

§ 3.4.3 Addenda will be issued no later than four days prior to the date for receipt of Bids except an Addendum withdrawing the request for Bids or one which includes postponement of the date for receipt of Bids.

§ 3.4.4 Each Bidder shall ascertain prior to submitting a Bid that the Bidder has received all Addenda issued, and the Bidder shall acknowledge their receipt in the Bid.

## ARTICLE 4 BIDDING PROCEDURES

### § 4.1 PREPARATION OF BIDS

§ 4.1.1 Bids shall be submitted on the forms included with the Bidding Documents.



§ 4.1.2 All blanks on the bid form shall be legibly executed in a non-erasable medium.

§ 4.1.3 Sums shall be expressed in both words and figures. In case of discrepancy, the amount written in words shall govern.

§ 4.1.4 Interlineations, alterations and erasures must be initialed by the signer of the Bid.

§ 4.1.5 All requested Alternates shall be bid. If no change in the Base Bid is required, enter "No Change."

§ 4.1.6 Where two or more Bids for designated portions of the Work have been requested, the Bidder may, without forfeiture of the bid security, state the Bidder's refusal to accept award of less than the combination of Bids stipulated by the Bidder. The Bidder shall make no additional stipulations on the bid form nor qualify the Bid in any other manner.

§ 4.1.7 Each copy of the Bid shall state the legal name of the Bidder and the nature of legal form of the Bidder. The Bidder shall provide evidence of legal authority to perform within the jurisdiction of the Work. Each copy shall be signed by the person or persons legally authorized to bind the Bidder to a contract. A Bid by a corporation shall further give the state of incorporation and have the corporate seal affixed. A Bid submitted by an agent shall have a current power of attorney attached certifying the agent's authority to bind the Bidder.

#### § 4.2 BID SECURITY

§ 4.2.1 Each Bid shall be accompanied by a bid security in the form and amount required if so stipulated in the Instructions to Bidders. The Bidder pledges to enter into a Contract with the Owner on the terms stated in the Bid and will, if required, furnish bonds covering the faithful performance of the Contract and payment of all obligations arising thereunder. Should the Bidder refuse to enter into such Contract or fail to furnish such bonds if required, the amount of the bid security shall be forfeited to the Owner as liquidated damages, not as a penalty. The amount of the bid security shall not be forfeited to the Owner in the event the Owner fails to comply with Section 6.2.

§ 4.2.2 If a surety bond is required, it shall be written on AIA Document A310, Bid Bond, unless otherwise provided in the Bidding Documents, and the attorney-in-fact who executes the bond on behalf of the surety shall affix to the bond a certified and current copy of the power of attorney.

§ 4.2.3 The Owner will have the right to retain the bid security of Bidders to whom an award is being considered until either (a) the Contract has been executed and bonds, if required, have been furnished, or (b) the specified time has elapsed so that Bids may be withdrawn or (c) all Bids have been rejected.

#### § 4.3 SUBMISSION OF BIDS

§ 4.3.1 All copies of the Bid, the bid security, if any, and any other documents required to be submitted with the Bid shall be enclosed in a sealed opaque envelope. The envelope shall be addressed to the party receiving the Bids and shall be identified with the Project name, the Bidder's name and address and, if applicable, the designated portion of the Work for which the Bid is submitted. If the Bid is sent by mail, the sealed envelope shall be enclosed in a separate mailing envelope with the notation "SEALED BID ENCLOSED" on the face thereof.

§ 4.3.2 Bids shall be deposited at the designated location prior to the time and date for receipt of Bids. Bids received after the time and date for receipt of Bids will be returned unopened.

§ 4.3.3 The Bidder shall assume full responsibility for timely delivery at the location designated for receipt of Bids.

§ 4.3.4 Oral, telephonic, telegraphic, facsimile or other electronically transmitted bids will not be considered.

#### § 4.4 MODIFICATION OR WITHDRAWAL OF BID

§ 4.4.1 A Bid may not be modified, withdrawn or canceled by the Bidder during the stipulated time period following the time and date designated for the receipt of Bids, and each Bidder so agrees in submitting a Bid.

§ 4.4.2 Prior to the time and date designated for receipt of Bids, a Bid submitted may be modified or withdrawn by notice to the party receiving Bids at the place designated for receipt of Bids. Such notice shall be in writing over the



signature of the Bidder. Written confirmation over the signature of the Bidder shall be received, and date- and time-stamped by the receiving party on or before the date and time set for receipt of Bids. A change shall be so worded as not to reveal the amount of the original Bid.

§ 4.4.3 Withdrawn Bids may be resubmitted up to the date and time designated for the receipt of Bids provided that they are then fully in conformance with these Instructions to Bidders.

§ 4.4.4 Bid security, if required, shall be in an amount sufficient for the Bid as resubmitted.

## ARTICLE 5 CONSIDERATION OF BIDS

### § 5.1 OPENING OF BIDS

At the discretion of the Owner, if stipulated in the Advertisement or Invitation to Bid, the properly identified Bids received on time will be publicly opened and will be read aloud. An abstract of the Bids may be made available to Bidders.

### § 5.2 REJECTION OF BIDS

The Owner shall have the right to reject any or all Bids. A Bid not accompanied by a required bid security or by other data required by the Bidding Documents, or a Bid which is in any way incomplete or irregular is subject to rejection.

### § 5.3 ACCEPTANCE OF BID (AWARD)

§ 5.3.1 It is the intent of the Owner to award a Contract to the lowest qualified Bidder provided the Bid has been submitted in accordance with the requirements of the Bidding Documents and does not exceed the funds available. The Owner shall have the right to waive informalities and irregularities in a Bid received and to accept the Bid which, in the Owner's judgment, is in the Owner's own best interests.

§ 5.3.2 The Owner shall have the right to accept Alternates in any order or combination, unless otherwise specifically provided in the Bidding Documents, and to determine the low Bidder on the basis of the sum of the Base Bid and Alternates accepted.

## ARTICLE 6 POST-BID INFORMATION

### § 6.1 CONTRACTOR'S QUALIFICATION STATEMENT

Bidders to whom award of a Contract is under consideration shall submit to the Architect, upon request, a properly executed AIA Document A305, Contractor's Qualification Statement, unless such a Statement has been previously required and submitted as a prerequisite to the issuance of Bidding Documents.

### § 6.2 OWNER'S FINANCIAL CAPABILITY

The Owner shall, at the request of the Bidder to whom award of a Contract is under consideration and no later than seven days prior to the expiration of the time for withdrawal of Bids, furnish to the Bidder reasonable evidence that financial arrangements have been made to fulfill the Owner's obligations under the Contract. Unless such reasonable evidence is furnished, the Bidder will not be required to execute the Agreement between the Owner and Contractor.

### § 6.3 SUBMITTALS

§ 6.3.1 The Bidder shall, as soon as practicable or as stipulated in the Bidding Documents, after notification of selection for the award of a Contract, furnish to the Owner through the Architect in writing:

- .1 a designation of the Work to be performed with the Bidder's own forces;
- .2 names of the manufacturers, products, and the suppliers of principal items or systems of materials and equipment proposed for the Work; and
- .3 names of persons or entities (including those who are to furnish materials or equipment fabricated to a special design) proposed for the principal portions of the Work.

§ 6.3.2 The Bidder will be required to establish to the satisfaction of the Architect and Owner the reliability and responsibility of the persons or entities proposed to furnish and perform the Work described in the Bidding Documents.

§ 6.3.3 Prior to the execution of the Contract, the Architect will notify the Bidder in writing if either the Owner or Architect, after due investigation, has reasonable objection to a person or entity proposed by the Bidder. If the Owner or Architect has reasonable objection to a proposed person or entity, the Bidder may, at the Bidder's option, (1)



withdraw the Bid or (2) submit an acceptable substitute person or entity with an adjustment in the Base Bid or Alternate Bid to cover the difference in cost occasioned by such substitution. The Owner may accept the adjusted bid price or disqualify the Bidder. In the event of either withdrawal or disqualification, bid security will not be forfeited.

§ 6.3.4 Persons and entities proposed by the Bidder and to whom the Owner and Architect have made no reasonable objection must be used on the Work for which they were proposed and shall not be changed except with the written consent of the Owner and Architect.

## **ARTICLE 7 PERFORMANCE BOND AND PAYMENT BOND**

### **§ 7.1 BOND REQUIREMENTS**

§ 7.1.1 If stipulated in the Bidding Documents, the Bidder shall furnish bonds covering the faithful performance of the Contract and payment of all obligations arising thereunder. Bonds may be secured through the Bidder's usual sources.

§ 7.1.2 If the furnishing of such bonds is stipulated in the Bidding Documents, the cost shall be included in the Bid. If the furnishing of such bonds is required after receipt of bids and before execution of the Contract, the cost of such bonds shall be added to the Bid in determining the Contract Sum.

§ 7.1.3 If the Owner requires that bonds be secured from other than the Bidder's usual sources, changes in cost will be adjusted as provided in the Contract Documents.

### **§ 7.2 TIME OF DELIVERY AND FORM OF BONDS**

§ 7.2.1 The Bidder shall deliver the required bonds to the Owner not later than three days following the date of execution of the Contract. If the Work is to be commenced prior thereto in response to a letter of intent, the Bidder shall, prior to commencement of the Work, submit evidence satisfactory to the Owner that such bonds will be furnished and delivered in accordance with this Section 7.2.1.

§ 7.2.2 Unless otherwise provided, the bonds shall be written on AIA Document A312, Performance Bond and Payment Bond. Both bonds shall be written in the amount of the Contract Sum.

§ 7.2.3 The bonds shall be dated on or after the date of the Contract.

§ 7.2.4 The Bidder shall require the attorney-in-fact who executes the required bonds on behalf of the surety to affix thereto a certified and current copy of the power of attorney.

## **ARTICLE 8 FORM OF AGREEMENT BETWEEN OWNER AND CONTRACTOR**

Unless otherwise required in the Bidding Documents, the Agreement for the Work will be written on AIA Document A101, Standard Form of Agreement Between Owner and Contractor Where the Basis of Payment Is a Stipulated Sum.

**DOCUMENT 00 22 13**  
**SUPPLEMENTARY INSTRUCTIONS TO BIDDERS**

**PART 1 GENERAL**

The following Supplementary Instructions to Bidders modify, change from or add to AIA Document A701 Instruction To Bidders, 2007 Edition. Where any Article of the Instructions to Bidders is modified or any paragraph, subparagraph, or clause thereof is modified or deleted by these Supplementary Instructions to Bidders, the unaltered provisions of that Article, paragraph, subparagraph, or clause shall remain in effect.

**1.1 ARTICLE 2 BIDDER'S REPRESENTATIONS**

**A. Add the following subparagraphs to 2.1.3:**

2.1.3.1 Bidders are required to attend any mandatory pre-bid conferences or tours as stated in the Advertisement for Bids. Bidders not attending this pre-bid conference and tour shall be disqualified from bidding. Bidders will be required to sign in at the project site prior to the conference or tour.

2.1.3.2 Bidders are encouraged to visit the site(s) to become familiar with existing conditions. The Owner is not responsible and shall not bear financial burden for oversights made by the Bidder for failure to inspect sites prior to submitting a bid.

2.1.3.3 In all cases, persons wishing to examine the area of work must sign in at the school office prior to visiting the work area. Prior to leaving the school, sign-out at the office is required.

2.1.3.4 If access is required at times when the school office is not staffed, contact the Facilities Office, 541-790-7417, for assistance.

**B. Add the following paragraph 2.1.5:**

2.1.5 The Bidder certifies by signing the Bid that the Bidder has a drug-testing program in place for its employees that includes, at a minimum, the following:

- .1 A written employee drug-testing program,
- .2 Required drug testing for all new Subject Employees, or alternatively, requiring testing of Subject Employees every six months on a random selection basis,
- .3 Required testing of a Subject Employee when the Contractor has reasonable cause to believe the Subject Employee is under the influence of drugs, and
- .4 Required testing of a Subject Employee when the Subject Employee is involved in: (I) an incident causing an injury requiring treatment by a physician, or (ii) an incident resulting in damage to property or equipment.

A drug-testing program that meets the above requirements will be deemed a "Qualifying Employee Drug-testing Program". For purposes of this rule an employee is a "Subject Employee" only if that employee will be working on the Project job site; and

That if awarded the Public Improvement Contract, the Bidder will execute a contract in which the Contractor shall represent and warrant to the District that the Qualifying Employee Drug-testing Program is in place at the time of contract execution and will continue in full force and effect for the duration of the Public Improvement Contract; and that the Contract will condition the Agency's performance obligation upon the Contractor's compliance with this representation and warranty; and

That the Public Improvement Contract shall contain Contractor's covenant requiring each subcontractor providing labor for the Project to:

- .1 Demonstrate to the Contractor that it has a Qualifying Employee Drug-testing Program for the subcontractor's Subject Employees, and represent and warrant to the Contractor that the Qualifying Employee Drug-testing Program is in place at the time of subcontract execution and will continue in full force and effect for the duration of the subcontract; or
- .2 Require the subcontractor's Subject Employees to participate in the Contractor's Qualifying Employee Drug-testing Program for the duration of the subcontract.

## SUPPLEMENTARY INSTRUCTIONS TO BIDDERS – DOCUMENT 00 22 13

### 1.2 ARTICLE 3 BIDDING DOCUMENTS

#### A. 3.3 SUBSTITUTIONS

##### 1. Add the following:

3.3.2.1 All requests for approval must be submitted in duplicate on "Substitution Request Form". Include a self-addressed stamped envelope. Requests received by Architect less than ten (10) days prior to bid will not be considered.

#### B. 3.4 ADDENDA

##### 1. Delete paragraph 3.4.1 and substitute the following:

3.4.1 Addenda will be issued to plan centers listed in the Advertisement for Bids and all firms listed on the Planholder List.

### 1.3 ARTICLE 4 BIDDING PROCEDURES

#### A. 4.1 PREPARATION OF BIDS

##### 1. Add the following Paragraphs:

4.1.8 Bidders shall certify to non-collusion practices on the form included as part of the Bid Form, to be submitted with the Bid Form.

.1 A Non-Collusion Affidavit is required for any contract awarded pursuant to the bid. According to the Oregon Public Contracts and Purchasing Laws, a public contracting agency may reject any or all bids upon a finding of the agency that it is in the public interest to do so (ORS 279C.395). This agency finds that it is in the public interest to require the completion of this affidavit by potential contractors.

.2 The Non-Collusion Affidavit must be executed by the member, officer or employee of the bidder who makes the final decision on prices and the amount quoted in the bid.

.3 Bid rigging and other efforts to restrain competition, and the making of false sworn statements in connection with the submission of bids are unlawful and may be subject to criminal prosecution. The person who signs the Affidavit should examine it carefully before signing and assure himself or herself that each statement is true and accurate, making diligent inquiry, as necessary, of all other persons employed by or associated with the bidder with responsibilities for the preparation approval or submission of the bid.

.4 In the case of a bid submitted by a joint venture, each party to the venture must be identified in the bid documents, and an Affidavit must be submitted separately on behalf of each party.

.5 The term "complementary bid" as used in the Affidavit has the meaning commonly associated with the term in the bidding process, and includes the knowing submission of bids higher than the bid of another firm, any intentionally high or noncompetitive bid, and any other form of bid submitted for the purpose of giving a false appearance of competition.

.6 Failure to file an Affidavit in compliance with these instructions will result in disqualification of the bid.

4.1.9 Bidders shall certify to non-discrimination in employment practices on the form, included as part of the Bid Form, to be submitted with the Bid Form. By submitting its bid, the Bidder certifies conformance to the applicable federal acts, executive orders, and Oregon statutes and regulations concerning affirmative action toward equal employment opportunities. All information and reports required by the federal or Oregon state governments having responsibility for the enforcement of such laws shall be supplied to the Owner in compliance with such acts, regulation, and orders.

.1 Failure to file an Affidavit in compliance with these instructions will result in disqualification of the bid.

4.1.10 Bidder shall indicate, on the Bid Form where provided, the bidder's status as a "resident" or "non-resident" in accordance with ORS 279C.365 and ORS 279A.120.

4.1.11 First-Tier Subcontractor Disclosure:

.1 Within two working hours after the date and time of the deadline when the bids are due, a Bidder shall submit to the District a disclosure of the first-tier subcontractors that will be furnishing labor or will be furnishing labor and materials in connection with the public improvement; and will have a contract value that is equal to or greater than 5% of the project bid or \$15,000, whichever is greater, or \$350,000, regardless of the percentage of the total project bid.

.2 The disclosure of first-tier subcontractors shall include the name of each subcontractor, the category of work that the subcontractor would be performing, and the dollar value of each subcontract.

.3 The first-tier subcontractor disclosure applies only to public improvements with a contract value of more than \$100,000.

.4 The District will consider the bid of any contractor that does not submit a required subcontractor disclosure to the District to be a non-responsive bid. A non-responsive Bid will not be considered for Award.

.5 Contractor shall certify that all subcontractors performing Work are registered with the Construction Contractors Board or licensed by the State Landscape Contractors Board in accordance with ORS 701.035 to 701.055 before the subcontractors commence work under the Contract.

**B. 4.2 BID SECURITY**

1. Delete paragraphs 4.2.2 and 4.2.3 and substitute the following:

4.2.2 Each Bid shall be accompanied by a surety bond, cashiers check, or certified check, executed in favor of Eugene School District 4J, in the amount not less than ten percent (10%) of the total bid, based upon the total bid amount for those items bid upon. Should the Bidder refuse to enter into such Contract or fail to furnish Performance and Labor and Materials Payment Bonds and Certificates of Insurance as required by the Supplementary Conditions within ten (10) working days after contract forms are provided to the Bidder, the amount of the Bid Security may be forfeited to the Owner as liquidated damages, not as a penalty.

.1 The Surety Bond shall be written by a Bonding Company authorized and licensed by the Oregon Insurance Commissioner. The bonding company must be listed on the most current US Government Treasury List, Department Circular 570, or approved PRIOR TO BID SUBMISSION by the Eugene School District 4J's Risk Manager. The Bond shall be on a AIA Document A310, most current edition. The Attorney-in-Fact who executes the Bond on behalf of the Surety shall affix to the Bond, a certified copy of a power of attorney.

.2 The Owner will have the right to retain the Bid Security of Bidders until either; a) the Contract has been executed and Bonds have been furnished, or b) the specified time has elapsed so that Bids may be withdrawn, or c) all Bids have been rejected.

**C. 4.4 MODIFICATION OR WITHDRAWAL OF BID**

1. Delete paragraph 4.4.1 and substitute the following:

4.4.1 A Bid may not be withdrawn or canceled by the Bidder following the time and date designated for the receipt of bids to the expiration of a 60 day period. The Bid for that sixty days is irrevocable and each Bidder so agrees in submitting a Bid.

**1.4 ARTICLE 6 POST-BID INFORMATION**

A. Delete Paragraph 6.1.

B. Modify paragraph 6.3.1 as follows:

In the first sentence delete the phrase "as soon as practicable" and add "within 48 hours."

C. Add the following:

6.3.1.4 Where asbestos abatement is required, Contractor or appropriate subcontractor shall be licensed by the Department of Environmental Quality to perform "asbestos abatement work", per OAR 340-248-0120,

**SUPPLEMENTARY INSTRUCTIONS TO BIDDERS – DOCUMENT 00 22 13**

Adopted 1/25/90, and meet requirements of AHERA as specified in the Federal Register, 40 CFR part 763. Bidder shall submit evidence of licensing to Owner.

**1.5 ARTICLE 7 PERFORMANCE BOND AND PAYMENT BOND**

**A. 7.1 BOND REQUIREMENTS**

1. Delete paragraphs 7.1.1, 7.1.2 and 7.1.3 and add the following:

7.1.1 Unless otherwise stated in the solicitation document, prior to execution of the Agreement, the successful Bidder shall furnish a separate Performance Bond and a Labor Bond and Materials Payment Bond that in all respects conform to the requirements of ORS 279C.380 covering faithful performance of the Contract, and the payment of all obligations arising thereunder, each in an amount equal to one hundred percent (100%) of the Contract sum. The duration of the performance bond shall match the length of the project warranty.

7.1.2 Bonds shall be submitted on AIA Document A312, latest edition.

7.1.3 The surety issuing such bonds shall be duly authorized and licensed to issue bonds in the State of Oregon. The bonds shall be executed by an attorney-in-fact, principal or other authorized representative for the surety company, showing the Oregon agent for service, and bears the seal of the surety company. Where the bond is executed by a person outside the state of Oregon, his authority to execute bonds shall be shown. The Bonds shall be fully executed, payable to the Owner.

7.1.4 The cost of furnishing such bonds shall be included in the Bid.

**B. BOLI Public Works Bond:**

1. Add the following:

Pursuant to ORS 279C.836, for any contract awarded where the contract price is \$100,000.00 or greater, the Contractor and every subcontractor shall have a Public Works bond filed with the Construction Contractors Board before starting work on the project. This bond is in addition to performance bond and payment bond requirements. A copy of the Contractor's BOLI Public Works Bond shall be provided with the executed contract.

**1.2 TIME OF DELIVERY AND FORM OF BONDS**

A. Delete paragraph 7.2.1 and substitute the following:

7.2.1 The successful Bidder will be provided with contract forms through the Architect. These forms shall be executed and delivered to the Owner, along with Performance Bond and Labor and Material Payment Bond, within ten (10) days after receiving forms.

B. Add the following article:

**ARTICLE 9 MISCELLANEOUS PROVISIONS**

**9.1 ADMINISTRATIVE RULES**

All bidders are required to comply with the provisions of Oregon Revised Statutes and 4J Board Policy. Attention is directed to ORS 244, Government Ethics; ORS 279A and 279C, Public Contracting Code; Oregon Administrative Rules, Chapter 137, Divisions 46, 48 and 49; and 4J Board Policy DJC.

**9.2 PROTEST OF BID**

Protests of bid specifications or contract terms shall be presented to the Owner in writing five (5) calendar days prior to bid opening. Such protest or request for change shall include the reason for protest or request, and any proposed changes to specifications or terms. No protest against award because of the content of bid specifications or contract terms shall be considered after the deadline established for submitting such protest.

**9.3 PROTEST OF AWARD**

Any actual bidder or proposer who is adversely affected by the Owner's notice of award of the contract to another bidder or proposer on the same solicitation shall have seventy two (72) hours from the notice of award to submit to the Owner, a written protest of the notice of award. In order to be an adversely affected or aggrieved bidder or proposer with a right to submit a written protest, a bidder or proposer must itself claim to

**SUPPLEMENTARY INSTRUCTIONS TO BIDDERS – DOCUMENT 00 22 13**

be eligible for award of the contract as the lowest responsible bidder or best proposer and must be next in line for award.

**9.4 FINAL AWARD**

The written notice of award of the contract shall constitute a final decision of the Owner to award the contract if no written protest of the notice of award is filed with the Owner within the designated time.

END OF DOCUMENT 00 22 13

**DOCUMENT 00 41 13**  
**BID FORM**

**BID FOR:** Roosevelt Middle School

**CIP Number:** 410.566.001

**Submitted to:** Facilities Management  
Eugene School District 4J  
715 West Fourth Avenue  
Eugene, Oregon 97402

**Bid Deadline:** 2:00 pm  
February 4, 2016

Submitted by: \_\_\_\_\_  
(Company Name)

**BASE BID**

The undersigned proposes to furnish all material, equipment, and labor required for the complete project, and to perform all work in strict accordance with the Contract Documents for the lump sum prices indicated below with completion occurring on or prior to the dates indicated:

**BASE BID PACKAGE:**

Bid: \_\_\_\_\_ \$ \_\_\_\_\_  
(Words) (Figures)

The undersigned agrees, if awarded the Contract, to substantially complete all Base Bid Package work on or before the dates specified in Section 01 11 00.

**BID SECURITY**

Accompanying herewith is Bid Security, which is not less than ten percent (10%) of the total amount of the Base Bid plus additive alternates.

**STIPULATIONS**

The undersigned acknowledges the liquidated damages provision included in the Supplementary Conditions.

The undersigned agrees, if awarded the contract, to comply with the provisions of Oregon Revised Statutes 279C.800 through 279C.870 pertaining to the payment of prevailing rates of wage.

The undersigned agrees, if awarded the Contract, to execute and deliver to the Owner within ten (10) working days after receiving contract forms, a signed Agreement and a satisfactory Performance Bond and Payment Bond each in an amount equal to 100 percent (100%) of the Contract Sum.

For every Agreement of \$100,000 or greater in value, all Contractors and Subcontractors shall have a public works bond in the amount of \$30,000, filed with the Construction Contractors' Board (CCB), in compliance with ORS 279C.836, before starting work on the project unless exempt. Contractor agrees to provide a copy of the Contractor's BOLI Public Works bond with the signed Agreement as Specified in the Supplementary Conditions.

The undersigned agrees that the Bid Security accompanying this proposal is the measure of liquidated damages which the Owner will sustain by the failure of the undersigned to execute and deliver the above named agreement and bonds; and that if the undersigned defaults in executing that agreement within ten (10) days after forms are provided or providing the bonds, then the Bid Security shall become the property of the Owner; but if this proposal is not accepted within sixty (60) days of the time set for the opening of bids, or if the undersigned executes and delivers said agreement and bonds, the Bid Security shall be returned.

By submitting this Bid, the Bidder certifies that the Bidder:

- a) has available the appropriate financial, material, equipment, facility and personnel resources and expertise, or the ability to obtain the resources and expertise, necessary to meet all contractual responsibilities;
- b) has a satisfactory record of past performance;
- c) has a satisfactory record of integrity, and is not disqualified under ORS 279C.440;
- d) is qualified legally to contract with the Owner; and
- e) will promptly supply all necessary information in connection with any inquiry the Owner may make concerning the responsibility of the Bidder.

**BID FORM – DOCUMENT 00 41 13**

Prior to award of a Contract, the Bidder shall submit appropriate documentation to allow the Owner to determine whether or not the Bidder is “responsible” according to the above criteria.

The contractor agrees with the provisions of Oregon Revised Statutes 279C.505, which requires that the contractor shall demonstrate it has established a drug-testing program for employees and will require each subcontractor providing labor for the Project to do the same.

The undersigned has received addenda numbers \_\_\_\_\_ to \_\_\_\_\_ inclusive and has included their provisions in the above Bid amounts.

The undersigned has visited the site to become familiar with conditions under which the Work is to be performed and has correlated the Bidder's personal observations with the requirements of the proposed Contract Documents.

The undersigned certifies that the Bidder is a \_\_\_\_\_ Bidder under ORS. ("Resident" or "Non-resident", to be filled in by Bidder)

Names of Firm: \_\_\_\_\_

Street Address: \_\_\_\_\_  
(City) (State) (Zip)

Telephone Number: \_\_\_\_\_ FAX Number: \_\_\_\_\_

Email Address: \_\_\_\_\_

Signed By: \_\_\_\_\_ Printed Name: \_\_\_\_\_  
(Signature of Authorized Official. If bid is from a partnership, one of the partners must sign bid).

Date Signed: \_\_\_\_\_

Official Capacity: \_\_\_\_\_

If corporation, attest: \_\_\_\_\_ Date: \_\_\_\_\_  
(Secretary of Corporation)

SEAL (If Corporate) \_\_\_\_\_ Corporation  
\_\_\_\_\_ Partnership  
\_\_\_\_\_ Individual

Enclosed: Bid Security



**NON-DISCRIMINATION REQUIREMENT**

Contractor certifies that the Contractor has not discriminated against minorities, women or emerging small business enterprises in obtaining any required subcontracts.

The Contractor agrees not to discriminate against any client, employee, or applicant for employment or for services, because of race, color, religion, sex, national origin, physical or mental handicap, sexual orientation or age, unless based upon bona fide occupational qualifications, and that they are otherwise in compliance with all federal, state and local laws prohibiting discrimination, with regard to, but not limited to, the following: Employment upgrading, demotion or transfer; Recruitment or recruitment advertising; Layoffs or termination; Rates of pay or other forms of compensation; Selection for training; Rendition of services. It is further understood that any vendor who is in violation of this clause shall be barred forthwith from receiving awards of any purchase order from the School District, unless a satisfactory showing is made that discriminatory practices have terminated and that a recurrence of such acts is unlikely.

FIRM NAME: \_\_\_\_\_

ADDRESS: \_\_\_\_\_

TELEPHONE: \_\_\_\_\_

BY: \_\_\_\_\_  
(Company or Firm Officer)

BY: \_\_\_\_\_  
(Type or Print Name)

NON-COLLUSION AFFIDAVIT

STATE OF \_\_\_\_\_)

County of \_\_\_\_\_)

I state that I am \_\_\_\_\_ of \_\_\_\_\_  
(Title) (Name of Firm)

and that I am authorized to make this affidavit on behalf of my firm, and its owners, directors, and officers. I am the person responsible in my firm for the price(s) and the amount of this bid.

I state that:

(1) The price(s) and amount of this bid have been arrived at independently and without consultation, communication or agreement with any other contractor, bidder or potential bidder, except as disclosed on the attached appendix.

(2) That neither the price(s) nor the amount of this bid, and neither the approximate price(s) nor approximate amount of this bid, have been disclosed to any other firm or person who is a bidder or potential bidder, and they will not be disclosed before bid opening.

(3) No attempt has been made or will be made to induce any firm or person to refrain from bidding on this contract, or to submit a bid higher than this bid, or to submit any intentionally high or noncompetitive bid or other form of complementary bid.

(4) The bid of my firm is made in good faith and not pursuant to any agreement or discussion with, or inducement from, any firm or person to submit a complementary or noncompetitive bid.

(5) \_\_\_\_\_, its affiliates, subsidiaries, officers, directors and  
(Name of my Firm)

employees are not currently under investigation by any governmental agency and have not in the last four years been convicted of or found liable for any act prohibited by State or Federal law in any jurisdiction, involving conspiracy or collusion with respect to bidding on any public contract, except as described on the attached appendix.

I state that \_\_\_\_\_ understands and acknowledges that the above representations  
(Name of my Firm)

are material and important, and will be relied on by School District 4J in awarding the contract(s) for which this bid is submitted. I understand and my firm understands that any misstatement in this affidavit is and shall be treated as fraudulent concealment from School District 4J of the true facts relating to the submission of bids for this contract.

\_\_\_\_\_  
(Authorized Signature)

Sworn to and subscribed before me this \_\_\_\_\_ day of \_\_\_\_\_, 20

\_\_\_\_\_  
(Notary Public for Oregon)

My Commission Expires: \_\_\_\_\_

END OF BID FORM

**DOCUMENT 00 45 22**  
**FIRST-TIER SUBCONTRACTOR DISCLOSURE FORM**

**PROJECT:** Roosevelt Middle School

**CIP NUMBER:** 410.566.001

**TO:** Kathi Hernandez, Facilities Management Assistant  
Eugene School District 4J  
715 West Fourth Avenue  
Eugene, Oregon 97402

**BID SUBMISSION DEADLINE: Date:** February 4, 2016

**Time:** 2:00 pm

**SUBMITTAL REQUIREMENTS**

Subcontractor disclosure is required on all public improvement contracts greater than \$100,000.

This form must be submitted at the location specified in the Invitation to Bid on the advertised bid closing date and within two working hours after the advertised bid closing time.

List below the name of each subcontractor that will be furnishing labor or labor and materials, and that is required to be disclosed, the category of work that the subcontractor will be performing, and the dollar value of the subcontract. Enter "NONE" if there are no subcontractors that need to be disclosed. (ATTACH ADDITIONAL SHEETS IF NEEDED.)

SUBCONTRACTOR	DOLLAR VALUE	CATEGORY OF WORK
_____	_____	_____
_____	_____	_____
_____	_____	_____

The above listed first- tier subcontractor(s) are providing labor, or labor and material, with a Dollar Value equal to or greater than:

- a) 5% of the total Contract Price, but at least \$15,000. [If the Dollar Value is less than \$15,000 do not list the subcontractor above.]
- b) \$350,000 regardless of the percentage of the total Contract Price

Failure to submit this form by the disclosure deadline will result in a non-responsive bid. A non-responsive bid will not be considered for award.

**Form submitted by (Bidder Name):** \_\_\_\_\_

**Contact Name:** \_\_\_\_\_ **Phone:** \_\_\_\_\_

**Signature:** \_\_\_\_\_

END OF DOCUMENT 00 45 22

**DOCUMENT 00 52 13**  
**FORM OF AGREEMENT**

**PART 1 GENERAL**

**STANDARD FORM**

The form of Agreement will be executed on AIA Form A101, Standard Form of Agreement Between Owner and Contractor, 2007 edition, which is included by reference. The document, as edited by Owner, is available for review at <http://www.4j.lane.edu/bids/>.

END OF DOCUMENT 00 52 13

**DOCUMENT 00 72 13  
GENERAL CONDITIONS**

**PART 1 GENERAL**

**STANDARD FORM**

General Conditions of the Contract for Construction AIA Document A201, 2007 edition, immediately following, are part of these specifications.

The Contractor and all Subcontractors shall read and be governed by them.

**CONFLICTS**

In the case of conflicts between the General Conditions and these Specifications, the Specifications govern.

END OF DOCUMENT 00 72 13

# DRAFT AIA<sup>®</sup> Document A201<sup>™</sup> - 2007

## General Conditions of the Contract for Construction

for the following PROJECT:

(Name and location or address)

«test»

« »

THE OWNER:

(Name, legal status and address)

« »« »

« »

THE ARCHITECT:

(Name, legal status and address)

« »« »

« »

### TABLE OF ARTICLES

- |    |  |
|----|--|
| 1  | GENERAL PROVISIONS                               |
| 2  | OWNER  |
| 3  | CONTRACTOR                                       |
| 4  | ARCHITECT  |
| 5  | SUBCONTRACTORS                                   |
| 6  | CONSTRUCTION BY OWNER OR BY SEPARATE CONTRACTORS |
| 7  | CHANGES IN THE WORK                              |
| 8  | TIME   |
| 9  | PAYMENTS AND COMPLETION                          |
| 10 | PROTECTION OF PERSONS AND PROPERTY               |
| 11 | INSURANCE AND BONDS                              |
| 12 | UNCOVERING AND CORRECTION OF WORK                |
| 13 | MISCELLANEOUS PROVISIONS                         |
| 14 | TERMINATION OR SUSPENSION OF THE CONTRACT        |
| 15 | CLAIMS AND DISPUTES                              |

#### ADDITIONS AND DELETIONS:

The author of this document has added information needed for its completion. The author may also have revised the text of the original AIA standard form. An *Additions and Deletions Report* that notes added information as well as revisions to the standard form text is available from the author and should be reviewed.

This document has important legal consequences. Consultation with an attorney is encouraged with respect to its completion or modification.

**ELECTRONIC COPYING** of any portion of this AIA<sup>®</sup> Document to another electronic file is prohibited and constitutes a violation of copyright laws as set forth in the footer of this document.

## INDEX

(Topics and numbers in bold are section headings.)

### **Acceptance of Nonconforming Work**

9.6.6, 9.9.3, **12.3**

Acceptance of Work

9.6.6, 9.8.2, 9.9.3, 9.10.1, 9.10.3, **12.3**

### **Access to Work**

**3.16**, 6.2.1, 12.1

Accident Prevention

10

Acts and Omissions

3.2, 3.3.2, 3.12.8, 3.18, 4.2.3, 8.3.1, 9.5.1, 10.2.5, 10.2.8, 13.4.2, 13.7, 14.1, 15.2

Addenda

1.1.1, 3.11

Additional Costs, Claims for

3.7.4, 3.7.5, 6.1.1, 7.3.7.5, 10.3, 15.1.4

### **Additional Inspections and Testing**

9.4.2, 9.8.3, 12.2.1, **13.5**

Additional Insured

11.1.4

### **Additional Time, Claims for**

3.2.4, 3.7.4, 3.7.5, 3.10.2, 8.3.2, **15.1.5**

### **Administration of the Contract**

3.1.3, **4.2**, 9.4, 9.5

Advertisement or Invitation to Bid

1.1.1

Aesthetic Effect

4.2.13

### **Allowances**

**3.8**, 7.3.8

All-risk Insurance

11.3.1, 11.3.1.1

### **Applications for Payment**

4.2.5, 7.3.9, 9.2, **9.3**, 9.4, 9.5.1, 9.6.3, 9.7, 9.10, 11.1.3

Approvals

2.1.1, 2.2.2, 2.4, 3.1.3, 3.10.2, 3.12.8, 3.12.9, 3.12.10, 4.2.7, 9.3.2, 13.5.1

### **Arbitration**

8.3.1, 11.3.10, 13.1, 15.3.2, **15.4**

## **ARCHITECT**

**4**

**Architect**, Definition of

**4.1.1**

Architect, Extent of Authority

2.4, 3.12.7, 4.1, 4.2, 5.2, 6.3, 7.1.2, 7.3.7, 7.4, 9.2, 9.3.1, 9.4, 9.5, 9.6.3, 9.8, 9.10.1, 9.10.3, 12.1, 12.2.1, 13.5.1, 13.5.2, 14.2.2, 14.2.4, 15.1.3, 15.2.1

Architect, Limitations of Authority and

Responsibility

2.1.1, 3.12.4, 3.12.8, 3.12.10, 4.1.2, 4.2.1, 4.2.2, 4.2.3, 4.2.6, 4.2.7, 4.2.10, 4.2.12, 4.2.13, 5.2.1, 7.4, 9.4.2, 9.5.3, 9.6.4, 15.1.3, 15.2

Architect's Additional Services and Expenses

2.4, 11.3.1.1, 12.2.1, 13.5.2, 13.5.3, 14.2.4

Architect's Administration of the Contract

3.1.3, 4.2, 3.7.4, 15.2, 9.4.1, 9.5

Architect's Approvals

2.4, 3.1.3, 3.5, 3.10.2, 4.2.7

Architect's Authority to Reject Work

3.5, 4.2.6, 12.1.2, 12.2.1

Architect's Copyright

1.1.7, 1.5

Architect's Decisions

3.7.4, 4.2.6, 4.2.7, 4.2.11, 4.2.12, 4.2.13, 4.2.14, 6.3, 7.3.7, 7.3.9, 8.1.3, 8.3.1, 9.2, 9.4.1, 9.5, 9.8.4, 9.9.1, 13.5.2, 15.2, 15.3

Architect's Inspections

3.7.4, 4.2.2, 4.2.9, 9.4.2, 9.8.3, 9.9.2, 9.10.1, 13.5

Architect's Instructions

3.2.4, 3.3.1, 4.2.6, 4.2.7, 13.5.2

Architect's Interpretations

4.2.11, 4.2.12

Architect's Project Representative

4.2.10

Architect's Relationship with Contractor

1.1.2, 1.5, 3.1.3, 3.2.2, 3.2.3, 3.2.4, 3.3.1, 3.4.2, 3.5, 3.7.4, 3.7.5, 3.9.2, 3.9.3, 3.10, 3.11, 3.12, 3.16, 3.18, 4.1.2, 4.1.3, 4.2, 5.2, 6.2.2, 7, 8.3.1, 9.2, 9.3, 9.4, 9.5, 9.7, 9.8, 9.9, 10.2.6, 10.3, 11.3.7, 12, 13.4.2, 13.5, 15.2

Architect's Relationship with Subcontractors

1.1.2, 4.2.3, 4.2.4, 4.2.6, 9.6.3, 9.6.4, 11.3.7

Architect's Representations

9.4.2, 9.5.1, 9.10.1

Architect's Site Visits

3.7.4, 4.2.2, 4.2.9, 9.4.2, 9.5.1, 9.9.2, 9.10.1, 13.5

Asbestos

10.3.1

Attorneys' Fees

3.18.1, 9.10.2, 10.3.3

Award of Separate Contracts

6.1.1, 6.1.2

### **Award of Subcontracts and Other Contracts for Portions of the Work**

**5.2**

### **Basic Definitions**

**1.1**

Bidding Requirements

1.1.1, 5.2.1, 11.4.1

Binding Dispute Resolution

9.7, 11.3.9, 11.3.10, 13.1, 15.2.5, 15.2.6.1, 15.3.1, 15.3.2, 15.4.1

### **Boiler and Machinery Insurance**

**11.3.2**

Bonds, Lien

7.3.7.4, 9.10.2, 9.10.3

### **Bonds, Performance, and Payment**

7.3.7.4, 9.6.7, 9.10.3, 11.3.9, **11.4**



Building Permit  
3.7.1  
**Capitalization**  
**1.3**  
Certificate of Substantial Completion  
9.8.3, 9.8.4, 9.8.5  
**Certificates for Payment**  
4.2.1, 4.2.5, 4.2.9, 9.3.3, 9.4, 9.5, 9.6.1, 9.6.6, 9.7,  
9.10.1, 9.10.3, 14.1.1.3, 14.2.4, 15.1.3  
Certificates of Inspection, Testing or Approval  
13.5.4  
Certificates of Insurance  
9.10.2, 11.1.3  
**Change Orders**  
1.1.1, 2.4, 3.4.2, 3.7.4, 3.8.2.3, 3.11, 3.12.8, 4.2.8,  
5.2.3, 7.1.2, 7.1.3, 7.2, 7.3.2, 7.3.6, 7.3.9, 7.3.10,  
8.3.1, 9.3.1.1, 9.10.3, 10.3.2, 11.3.1.2, 11.3.4, 11.3.9,  
12.1.2, 15.1.3  
**Change Orders, Definition of**  
**7.2.1**  
**CHANGES IN THE WORK**  
2.2.1, 3.11, 4.2.8, 7, 7.2.1, 7.3.1, 7.4, 8.3.1, 9.3.1.1,  
11.3.9  
**Claims, Definition of**  
**15.1.1**  
**CLAIMS AND DISPUTES**  
3.2.4, 6.1.1, 6.3, 7.3.9, 9.3.3, 9.10.4, 10.3.3, 15, 15.4  
Claims and Timely Assertion of Claims  
15.4.1  
**Claims for Additional Cost**  
3.2.4, 3.7.4, 6.1.1, 7.3.9, 10.3.2, 15.1.4  
**Claims for Additional Time**  
3.2.4, 3.7.4, 6.1.1, 8.3.2, 10.3.2, 15.1.5  
**Concealed or Unknown Conditions, Claims for**  
**3.7.4**  
Claims for Damages  
3.2.4, 3.18, 6.1.1, 8.3.3, 9.5.1, 9.6.7, 10.3.3, 11.1.1,  
11.3.5, 11.3.7, 14.1.3, 14.2.4, 15.1.6  
Claims Subject to Arbitration  
15.3.1, 15.4.1  
**Cleaning Up**  
**3.15, 6.3**  
Commencement of the Work, Conditions Relating to  
2.2.1, 3.2.2, 3.4.1, 3.7.1, 3.10.1, 3.12.6, 5.2.1, 5.2.3,  
6.2.2, 8.1.2, 8.2.2, 8.3.1, 11.1, 11.3.1, 11.3.6, 11.4.1,  
15.1.4  
**Commencement of the Work, Definition of**  
**8.1.2**  
**Communications Facilitating Contract**  
**Administration**  
3.9.1, 4.2.4  
Completion, Conditions Relating to  
3.4.1, 3.11, 3.15, 4.2.2, 4.2.9, 8.2, 9.4.2, 9.8, 9.9.1,  
9.10, 12.2, 13.7, 14.1.2  
**COMPLETION, PAYMENTS AND**  
**9**

Completion, Substantial  
4.2.9, 8.1.1, 8.1.3, 8.2.3, 9.4.2, 9.8, 9.9.1, 9.10.3,  
12.2, 13.7  
Compliance with Laws  
1.6, 3.2.3, 3.6, 3.7, 3.12.10, 3.13, 4.1.1, 9.6.4, 10.2.2,  
11.1, 11.3, 13.1, 13.4, 13.5.1, 13.5.2, 13.6, 14.1.1,  
14.2.1.3, 15.2.8, 15.4.2, 15.4.3  
Concealed or Unknown Conditions  
3.7.4, 4.2.8, 8.3.1, 10.3  
Conditions of the Contract  
1.1.1, 6.1.1, 6.1.4  
Consent, Written  
3.4.2, 3.7.4, 3.12.8, 3.14.2, 4.1.2, 9.3.2, 9.8.5, 9.9.1,  
9.10.2, 9.10.3, 11.3.1, 13.2, 13.4.2, 15.4.4.2  
**Consolidation or Joinder**  
**15.4.4**  
**CONSTRUCTION BY OWNER OR BY**  
**SEPARATE CONTRACTORS**  
1.1.4, 6  
**Construction Change Directive, Definition of**  
**7.3.1**  
**Construction Change Directives**  
1.1.1, 3.4.2, 3.12.8, 4.2.8, 7.1.1, 7.1.2, 7.1.3, 7.3,  
9.3.1.1  
Construction Schedules, Contractor's  
3.10, 3.12.1, 3.12.2, 6.1.3, 15.1.5.2  
**Contingent Assignment of Subcontracts**  
**5.4, 14.2.2.2**  
**Continuing Contract Performance**  
**15.1.3**  
**Contract, Definition of**  
**1.1.2**  
**CONTRACT, TERMINATION OR**  
**SUSPENSION OF THE**  
5.4.1.1, 11.3.9, 14  
Contract Administration  
3.1.3, 4, 9.4, 9.5  
Contract Award and Execution, Conditions Relating  
to  
3.7.1, 3.10, 5.2, 6.1, 11.1.3, 11.3.6, 11.4.1  
Contract Documents, Copies Furnished and Use of  
1.5.2, 2.2.5, 5.3  
**Contract Documents, Definition of**  
**1.1.1**  
**Contract Sum**  
3.7.4, 3.8, 5.2.3, 7.2, 7.3, 7.4, 9.1, 9.4.2, 9.5.1.4,  
9.6.7, 9.7, 10.3.2, 11.3.1, 14.2.4, 14.3.2, 15.1.4,  
15.2.5  
**Contract Sum, Definition of**  
**9.1**  
Contract Time  
3.7.4, 3.7.5, 3.10.2, 5.2.3, 7.2.1.3, 7.3.1, 7.3.5, 7.4,  
8.1.1, 8.2.1, 8.3.1, 9.5.1, 9.7, 10.3.2, 12.1.1, 14.3.2,  
15.1.5.1, 15.2.5  
**Contract Time, Definition of**  
**8.1.1**



## **CONTRACTOR**

**3**

**Contractor, Definition of**

**3.1, 6.1.2**

**Contractor's Construction Schedules**

**3.10, 3.12.1, 3.12.2, 6.1.3, 15.1.5.2**

**Contractor's Employees**

**3.3.2, 3.4.3, 3.8.1, 3.9, 3.18.2, 4.2.3, 4.2.6, 10.2, 10.3, 11.1.1, 11.3.7, 14.1, 14.2.1.1**

**Contractor's Liability Insurance**

**11.1**

**Contractor's Relationship with Separate Contractors and Owner's Forces**

**3.12.5, 3.14.2, 4.2.4, 6, 11.3.7, 12.1.2, 12.2.4**

**Contractor's Relationship with Subcontractors**

**1.2.2, 3.3.2, 3.18.1, 3.18.2, 5, 9.6.2, 9.6.7, 9.10.2, 11.3.1.2, 11.3.7, 11.3.8**

**Contractor's Relationship with the Architect**

**1.1.2, 1.5, 3.1.3, 3.2.2, 3.2.3, 3.2.4, 3.3.1, 3.4.2, 3.5, 3.7.4, 3.10, 3.11, 3.12, 3.16, 3.18, 4.1.3, 4.2, 5.2, 6.2.2, 7, 8.3.1, 9.2, 9.3, 9.4, 9.5, 9.7, 9.8, 9.9, 10.2.6, 10.3, 11.3.7, 12, 13.5, 15.1.2, 15.2.1**

**Contractor's Representations**

**3.2.1, 3.2.2, 3.5, 3.12.6, 6.2.2, 8.2.1, 9.3.3, 9.8.2**

**Contractor's Responsibility for Those Performing the Work**

**3.3.2, 3.18, 5.3, 6.1.3, 6.2, 9.5.1, 10.2.8**

**Contractor's Review of Contract Documents**

**3.2**

**Contractor's Right to Stop the Work**

**9.7**

**Contractor's Right to Terminate the Contract**

**14.1, 15.1.6**

**Contractor's Submittals**

**3.10, 3.11, 3.12.4, 4.2.7, 5.2.1, 5.2.3, 9.2, 9.3, 9.8.2, 9.8.3, 9.9.1, 9.10.2, 9.10.3, 11.1.3, 11.4.2**

**Contractor's Superintendent**

**3.9, 10.2.6**

**Contractor's Supervision and Construction**

**Procedures**

**1.2.2, 3.3, 3.4, 3.12.10, 4.2.2, 4.2.7, 6.1.3, 6.2.4, 7.1.3, 7.3.5, 7.3.7, 8.2, 10, 12, 14, 15.1.3**

**Contractual Liability Insurance**

**11.1.1.8, 11.2**

**Coordination and Correlation**

**1.2, 3.2.1, 3.3.1, 3.10, 3.12.6, 6.1.3, 6.2.1**

**Copies Furnished of Drawings and Specifications**

**1.5, 2.2.5, 3.11**

**Copyrights**

**1.5, 3.17**

**Correction of Work**

**2.3, 2.4, 3.7.3, 9.4.2, 9.8.2, 9.8.3, 9.9.1, 12.1.2, 12.2**

**Correlation and Intent of the Contract Documents**

**1.2**

**Cost, Definition of**

**7.3.7**

**Costs**

**2.4, 3.2.4, 3.7.3, 3.8.2, 3.15.2, 5.4.2, 6.1.1, 6.2.3, 7.3.3.3, 7.3.7, 7.3.8, 7.3.9, 9.10.2, 10.3.2, 10.3.6, 11.3, 12.1.2, 12.2.1, 12.2.4, 13.5, 14**

**Cutting and Patching**

**3.14, 6.2.5**

**Damage to Construction of Owner or Separate Contractors**

**3.14.2, 6.2.4, 10.2.1.2, 10.2.5, 10.4, 11.1.1, 11.3, 12.2.4**

**Damage to the Work**

**3.14.2, 9.9.1, 10.2.1.2, 10.2.5, 10.4, 11.3.1, 12.2.4**

**Damages, Claims for**

**3.2.4, 3.18, 6.1.1, 8.3.3, 9.5.1, 9.6.7, 10.3.3, 11.1.1, 11.3.5, 11.3.7, 14.1.3, 14.2.4, 15.1.6**

**Damages for Delay**

**6.1.1, 8.3.3, 9.5.1.6, 9.7, 10.3.2**

**Date of Commencement of the Work, Definition of**

**8.1.2**

**Date of Substantial Completion, Definition of**

**8.1.3**

**Day, Definition of**

**8.1.4**

**Decisions of the Architect**

**3.7.4, 4.2.6, 4.2.7, 4.2.11, 4.2.12, 4.2.13, 15.2, 6.3, 7.3.7, 7.3.9, 8.1.3, 8.3.1, 9.2, 9.4, 9.5.1, 9.8.4, 9.9.1, 13.5.2, 14.2.2, 14.2.4, 15.1, 15.2**

**Decisions to Withhold Certification**

**9.4.1, 9.5, 9.7, 14.1.1.3**

**Defective or Nonconforming Work, Acceptance, Rejection and Correction of**

**2.3, 2.4, 3.5, 4.2.6, 6.2.5, 9.5.1, 9.5.2, 9.6.6, 9.8.2, 9.9.3, 9.10.4, 12.2.1**

**Definitions**

**1.1, 2.1.1, 3.1.1, 3.5, 3.12.1, 3.12.2, 3.12.3, 4.1.1, 15.1.1, 5.1, 6.1.2, 7.2.1, 7.3.1, 8.1, 9.1, 9.8.1**

**Delays and Extensions of Time**

**3.2, 3.7.4, 5.2.3, 7.2.1, 7.3.1, 7.4, 8.3, 9.5.1, 9.7, 10.3.2, 10.4, 14.3.2, 15.1.5, 15.2.5**

**Disputes**

**6.3, 7.3.9, 15.1, 15.2**

**Documents and Samples at the Site**

**3.11**

**Drawings, Definition of**

**1.1.5**

**Drawings and Specifications, Use and Ownership of**

**3.11**

**Effective Date of Insurance**

**8.2.2, 11.1.2**

**Emergencies**

**10.4, 14.1.1.2, 15.1.4**

**Employees, Contractor's**

**3.3.2, 3.4.3, 3.8.1, 3.9, 3.18.2, 4.2.3, 4.2.6, 10.2, 10.3.3, 11.1.1, 11.3.7, 14.1, 14.2.1.1**



Equipment, Labor, Materials or  
1.1.3, 1.1.6, 3.4, 3.5, 3.8.2, 3.8.3, 3.12, 3.13, 3.15.1,  
4.2.6, 4.2.7, 5.2.1, 6.2.1, 7.3.7, 9.3.2, 9.3.3, 9.5.1.3,  
9.10.2, 10.2.1, 10.2.4, 14.2.1.1, 14.2.1.2  
Execution and Progress of the Work  
1.1.3, 1.2.1, 1.2.2, 2.2.3, 2.2.5, 3.1, 3.3.1, 3.4.1, 3.5,  
3.7.1, 3.10.1, 3.12, 3.14, 4.2, 6.2.2, 7.1.3, 7.3.5, 8.2,  
9.5.1, 9.9.1, 10.2, 10.3, 12.2, 14.2, 14.3.1, 15.1.3  
Extensions of Time  
3.2.4, 3.7.4, 5.2.3, 7.2.1, 7.3, 7.4, 9.5.1, 9.7, 10.3.2,  
10.4, 14.3, 15.1.5, 15.2.5  
**Failure of Payment**  
9.5.1.3, 9.7, 9.10.2, 13.6, 14.1.1.3, 14.2.1.2  
Faulty Work  
(See Defective or Nonconforming Work)  
**Final Completion and Final Payment**  
4.2.1, 4.2.9, 9.8.2, 9.10, 11.1.2, 11.1.3, 11.3.1, 11.3.5,  
12.3, 14.2.4, 14.4.3  
Financial Arrangements, Owner's  
2.2.1, 13.2.2, 14.1.1.4  
Fire and Extended Coverage Insurance  
11.3.1.1  
**GENERAL PROVISIONS**  
**1**  
**Governing Law**  
**13.1**  
Guarantees (See Warranty)  
**Hazardous Materials**  
10.2.4, 10.3  
Identification of Subcontractors and Suppliers  
5.2.1  
**Indemnification**  
3.17, 3.18, 9.10.2, 10.3.3, 10.3.5, 10.3.6, 11.3.1.2,  
11.3.7  
**Information and Services Required of the Owner**  
2.1.2, 2.2, 3.2.2, 3.12.4, 3.12.10, 6.1.3, 6.1.4, 6.2.5,  
9.6.1, 9.6.4, 9.9.2, 9.10.3, 10.3.3, 11.2, 11.4, 13.5.1,  
13.5.2, 14.1.1.4, 14.1.4, 15.1.3  
**Initial Decision**  
**15.2**  
**Initial Decision Maker, Definition of**  
1.1.8  
Initial Decision Maker, Decisions  
14.2.2, 14.2.4, 15.2.1, 15.2.2, 15.2.3, 15.2.4, 15.2.5  
Initial Decision Maker, Extent of Authority  
14.2.2, 14.2.4, 15.1.3, 15.2.1, 15.2.2, 15.2.3, 15.2.4,  
15.2.5  
**Injury or Damage to Person or Property**  
**10.2.8, 10.4**  
Inspections  
3.1.3, 3.3.3, 3.7.1, 4.2.2, 4.2.6, 4.2.9, 9.4.2, 9.8.3,  
9.9.2, 9.10.1, 12.2.1, 13.5  
Instructions to Bidders  
1.1.1  
Instructions to the Contractor  
3.2.4, 3.3.1, 3.8.1, 5.2.1, 7, 8.2.2, 12, 13.5.2

**Instruments of Service, Definition of**  
**1.1.7**  
Insurance  
3.18.1, 6.1.1, 7.3.7, 9.3.2, 9.8.4, 9.9.1, 9.10.2, 11  
**Insurance, Boiler and Machinery**  
**11.3.2**  
**Insurance, Contractor's Liability**  
**11.1**  
Insurance, Effective Date of  
8.2.2, 11.1.2  
**Insurance, Loss of Use**  
**11.3.3**  
**Insurance, Owner's Liability**  
**11.2**  
**Insurance, Property**  
10.2.5, 11.3  
Insurance, Stored Materials  
9.3.2  
**INSURANCE AND BONDS**  
**11**  
Insurance Companies, Consent to Partial Occupancy  
9.9.1  
Intent of the Contract Documents  
1.2.1, 4.2.7, 4.2.12, 4.2.13, 7.4  
**Interest**  
**13.6**  
**Interpretation**  
1.2.3, 1.4, 4.1.1, 5.1, 6.1.2, 15.1.1  
Interpretations, Written  
4.2.11, 4.2.12, 15.1.4  
Judgment on Final Award  
15.4.2  
**Labor and Materials, Equipment**  
1.1.3, 1.1.6, 3.4, 3.5, 3.8.2, 3.8.3, 3.12, 3.13, 3.15.1,  
4.2.6, 4.2.7, 5.2.1, 6.2.1, 7.3.7, 9.3.2, 9.3.3, 9.5.1.3,  
9.10.2, 10.2.1, 10.2.4, 14.2.1.1, 14.2.1.2  
Labor Disputes  
8.3.1  
Laws and Regulations  
1.5, 3.2.3, 3.6, 3.7, 3.12.10, 3.13, 4.1.1, 9.6.4, 9.9.1,  
10.2.2, 11.1.1, 11.3, 13.1, 13.4, 13.5.1, 13.5.2, 13.6,  
14, 15.2.8, 15.4  
Liens  
2.1.2, 9.3.3, 9.10.2, 9.10.4, 15.2.8  
Limitations, Statutes of  
12.2.5, 13.7, 15.4.1.1  
Limitations of Liability  
2.3, 3.2.2, 3.5, 3.12.10, 3.17, 3.18.1, 4.2.6, 4.2.7,  
4.2.12, 6.2.2, 9.4.2, 9.6.4, 9.6.7, 10.2.5, 10.3.3,  
11.1.2, 11.2, 11.3.7, 12.2.5, 13.4.2  
Limitations of Time  
2.1.2, 2.2, 2.4, 3.2.2, 3.10, 3.11, 3.12.5, 3.15.1, 4.2.7,  
5.2, 5.3, 5.4.1, 6.2.4, 7.3, 7.4, 8.2, 9.2, 9.3.1, 9.3.3,  
9.4.1, 9.5, 9.6, 9.7, 9.8, 9.9, 9.10, 11.1.3, 11.3.1.5,  
11.3.6, 11.3.10, 12.2, 13.5, 13.7, 14, 15  
**Loss of Use Insurance**  
**11.3.3**



Material Suppliers  
1.5, 3.12.1, 4.2.4, 4.2.6, 5.2.1, 9.3, 9.4.2, 9.6, 9.10.5

**Materials, Hazardous**  
10.2.4, **10.3**

Materials, Labor, Equipment and  
1.1.3, 1.1.6, 1.5.1, 3.4.1, 3.5, 3.8.2, 3.8.3, 3.12, 3.13,  
3.15.1, 4.2.6, 4.2.7, 5.2.1, 6.2.1, 7.3.7, 9.3.2, 9.3.3,  
9.5.1.3, 9.10.2, 10.2.1.2, 10.2.4, 14.2.1.1, 14.2.1.2

Means, Methods, Techniques, Sequences and  
Procedures of Construction  
3.3.1, 3.12.10, 4.2.2, 4.2.7, 9.4.2

Mechanic's Lien  
2.1.2, 15.2.8

**Mediation**  
8.3.1, 10.3.5, 10.3.6, 15.2.1, 15.2.5, 15.2.6, **15.3**,  
15.4.1

**Minor Changes in the Work**  
1.1.1, 3.12.8, 4.2.8, 7.1, **7.4**

**MISCELLANEOUS PROVISIONS**  
**13**

**Modifications, Definition of**  
**1.1.1**  
Modifications to the Contract  
1.1.1, 1.1.2, 3.11, 4.1.2, 4.2.1, 5.2.3, 7, 8.3.1, 9.7,  
10.3.2, 11.3.1

**Mutual Responsibility**  
**6.2**

**Nonconforming Work, Acceptance of**  
9.6.6, 9.9.3, **12.3**

Nonconforming Work, Rejection and Correction of  
2.3, 2.4, 3.5, 4.2.6, 6.2.4, 9.5.1, 9.8.2, 9.9.3, 9.10.4,  
12.2.1

Notice  
2.2.1, 2.3, 2.4, 3.2.4, 3.3.1, 3.7.2, 3.12.9, 5.2.1, 9.7,  
9.10, 10.2.2, 11.1.3, 12.2.2.1, 13.3, 13.5.1, 13.5.2,  
14.1, 14.2, 15.2.8, 15.4.1

**Notice, Written**  
2.3, 2.4, 3.3.1, 3.9.2, 3.12.9, 3.12.10, 5.2.1, 9.7, 9.10,  
10.2.2, 10.3, 11.1.3, 11.3.6, 12.2.2.1, **13.3**, 14, 15.2.8,  
15.4.1

**Notice of Claims**  
3.7.4, 10.2.8, **15.1.2**, 15.4

Notice of Testing and Inspections  
13.5.1, 13.5.2

Observations, Contractor's  
3.2, 3.7.4

Occupancy  
2.2.2, 9.6.6, 9.8, 11.3.1.5

Orders, Written  
1.1.1, 2.3, 3.9.2, 7, 8.2.2, 11.3.9, 12.1, 12.2.2.1,  
13.5.2, 14.3.1

**OWNER**  
**2**

**Owner, Definition of**  
**2.1.1**

**Owner, Information and Services Required of the**  
2.1.2, **2.2**, 3.2.2, 3.12.10, 6.1.3, 6.1.4, 6.2.5, 9.3.2,  
9.6.1, 9.6.4, 9.9.2, 9.10.3, 10.3.3, 11.2, 11.3, 13.5.1,  
13.5.2, 14.1.1.4, 14.1.4, 15.1.3

Owner's Authority  
1.5, 2.1.1, 2.3, 2.4, 3.4.2, 3.8.1, 3.12.10, 3.14.2, 4.1.2,  
4.1.3, 4.2.4, 4.2.9, 5.2.1, 5.2.4, 5.4.1, 6.1, 6.3, 7.2.1,  
7.3.1, 8.2.2, 8.3.1, 9.3.1, 9.3.2, 9.5.1, 9.6.4, 9.9.1,  
9.10.2, 10.3.2, 11.1.3, 11.3.3, 11.3.10, 12.2.2, 12.3,  
13.2.2, 14.3, 14.4, 15.2.7

Owner's Financial Capability  
2.2.1, 13.2.2, 14.1.1.4

**Owner's Liability Insurance**  
**11.2**

Owner's Relationship with Subcontractors  
1.1.2, 5.2, 5.3, 5.4, 9.6.4, 9.10.2, 14.2.2

**Owner's Right to Carry Out the Work**  
2.4, 14.2.2

**Owner's Right to Clean Up**  
**6.3**

**Owner's Right to Perform Construction and to  
Award Separate Contracts**  
**6.1**

**Owner's Right to Stop the Work**  
**2.3**

Owner's Right to Suspend the Work  
14.3

Owner's Right to Terminate the Contract  
14.2

**Ownership and Use of Drawings, Specifications  
and Other Instruments of Service**  
1.1.1, 1.1.6, 1.1.7, **1.5**, 2.2.5, 3.2.2, 3.11, 3.17, 4.2.12,  
5.3

**Partial Occupancy or Use**  
9.6.6, **9.9**, 11.3.1.5

**Patching, Cutting and**  
**3.14**, 6.2.5

Patents  
3.17

**Payment, Applications for**  
4.2.5, 7.3.9, 9.2, **9.3**, 9.4, 9.5, 9.6.3, 9.7, 9.8.5, 9.10.1,  
14.2.3, 14.2.4, 14.4.3

**Payment, Certificates for**  
4.2.5, 4.2.9, 9.3.3, **9.4**, 9.5, 9.6.1, 9.6.6, 9.7, 9.10.1,  
9.10.3, 13.7, 14.1.1.3, 14.2.4

**Payment, Failure of**  
9.5.1.3, **9.7**, 9.10.2, 13.6, 14.1.1.3, 14.2.1.2

Payment, Final  
4.2.1, 4.2.9, 9.8.2, 9.10, 11.1.2, 11.1.3, 11.4.1, 12.3,  
13.7, 14.2.4, 14.4.3

**Payment Bond, Performance Bond and**  
**7.3.7.4**, 9.6.7, 9.10.3, **11.4**

**Payments, Progress**  
9.3, **9.6**, 9.8.5, 9.10.3, 13.6, 14.2.3, 15.1.3

**PAYMENTS AND COMPLETION**  
**9**

Payments to Subcontractors  
 5.4.2, 9.5.1.3, 9.6.2, 9.6.3, 9.6.4, 9.6.7, 14.2.1.2  
 PCB  
 10.3.1  
**Performance Bond and Payment Bond**  
 7.3.7.4, 9.6.7, 9.10.3, 11.4  
**Permits, Fees, Notices and Compliance with Laws**  
 2.2.2, 3.7, 3.13, 7.3.7.4, 10.2.2  
**PERSONS AND PROPERTY, PROTECTION**  
**OF**  
**10**  
 Polychlorinated Biphenyl  
 10.3.1  
**Product Data, Definition of**  
**3.12.2**  
**Product Data and Samples, Shop Drawings**  
 3.11, 3.12, 4.2.7  
**Progress and Completion**  
 4.2.2, 8.2, 9.8, 9.9.1, 14.1.4, 15.1.3  
**Progress Payments**  
 9.3, 9.6, 9.8.5, 9.10.3, 13.6, 14.2.3, 15.1.3  
**Project, Definition of**  
**1.1.4**  
 Project Representatives  
 4.2.10  
**Property Insurance**  
 10.2.5, 11.3  
**PROTECTION OF PERSONS AND PROPERTY**  
**10**  
 Regulations and Laws  
 1.5, 3.2.3, 3.6, 3.7, 3.12.10, 3.13, 4.1.1, 9.6.4, 9.9.1,  
 10.2.2, 11.1, 11.4, 13.1, 13.4, 13.5.1, 13.5.2, 13.6, 14,  
 15.2.8, 15.4  
 Rejection of Work  
 3.5, 4.2.6, 12.2.1  
 Releases and Waivers of Liens  
 9.10.2  
 Representations  
 3.2.1, 3.5, 3.12.6, 6.2.2, 8.2.1, 9.3.3, 9.4.2, 9.5.1,  
 9.8.2, 9.10.1  
 Representatives  
 2.1.1, 3.1.1, 3.9, 4.1.1, 4.2.1, 4.2.2, 4.2.10, 5.1.1,  
 5.1.2, 13.2.1  
 Responsibility for Those Performing the Work  
 3.3.2, 3.18, 4.2.3, 5.3, 6.1.3, 6.2, 6.3, 9.5.1, 10  
 Retainage  
 9.3.1, 9.6.2, 9.8.5, 9.9.1, 9.10.2, 9.10.3  
**Review of Contract Documents and Field**  
**Conditions by Contractor**  
**3.2, 3.12.7, 6.1.3**  
 Review of Contractor's Submittals by Owner and  
 Architect  
 3.10.1, 3.10.2, 3.11, 3.12, 4.2, 5.2, 6.1.3, 9.2, 9.8.2  
 Review of Shop Drawings, Product Data and  
 Samples by Contractor  
 3.12

**Rights and Remedies**  
 1.1.2, 2.3, 2.4, 3.5, 3.7.4, 3.15.2, 4.2.6, 5.3, 5.4, 6.1,  
 6.3, 7.3.1, 8.3, 9.5.1, 9.7, 10.2.5, 10.3, 12.2.2, 12.2.4,  
 13.4, 14, 15.4  
**Royalties, Patents and Copyrights**  
**3.17**  
 Rules and Notices for Arbitration  
 15.4.1  
**Safety of Persons and Property**  
**10.2, 10.4**  
**Safety Precautions and Programs**  
 3.3.1, 4.2.2, 4.2.7, 5.3, 10.1, 10.2, 10.4  
**Samples, Definition of**  
**3.12.3**  
**Samples, Shop Drawings, Product Data and**  
**3.11, 3.12, 4.2.7**  
**Samples at the Site, Documents and**  
**3.11**  
**Schedule of Values**  
**9.2, 9.3.1**  
 Schedules, Construction  
 3.10, 3.12.1, 3.12.2, 6.1.3, 15.1.5.2  
 Separate Contracts and Contractors  
 1.1.4, 3.12.5, 3.14.2, 4.2.4, 4.2.7, 6, 8.3.1, 12.1.2  
**Shop Drawings, Definition of**  
**3.12.1**  
**Shop Drawings, Product Data and Samples**  
**3.11, 3.12, 4.2.7**  
**Site, Use of**  
**3.13, 6.1.1, 6.2.1**  
 Site Inspections  
 3.2.2, 3.3.3, 3.7.1, 3.7.4, 4.2, 9.4.2, 9.10.1, 13.5  
 Site Visits, Architect's  
 3.7.4, 4.2.2, 4.2.9, 9.4.2, 9.5.1, 9.9.2, 9.10.1, 13.5  
 Special Inspections and Testing  
 4.2.6, 12.2.1, 13.5  
**Specifications, Definition of**  
**1.1.6**  
**Specifications**  
 1.1.1, 1.1.6, 1.2.2, 1.5, 3.11, 3.12.10, 3.17, 4.2.14  
 Statute of Limitations  
 13.7, 15.4.1.1  
 Stopping the Work  
 2.3, 9.7, 10.3, 14.1  
 Stored Materials  
 6.2.1, 9.3.2, 10.2.1.2, 10.2.4  
**Subcontractor, Definition of**  
**5.1.1**  
**SUBCONTRACTORS**  
**5**  
 Subcontractors, Work by  
 1.2.2, 3.3.2, 3.12.1, 4.2.3, 5.2.3, 5.3, 5.4, 9.3.1.2,  
 9.6.7  
**Subcontractual Relations**  
**5.3, 5.4, 9.3.1.2, 9.6, 9.10, 10.2.1, 14.1, 14.2.1**



Submittals  
3.10, 3.11, 3.12, 4.2.7, 5.2.1, 5.2.3, 7.3.7, 9.2, 9.3,  
9.8, 9.9.1, 9.10.2, 9.10.3, 11.1.3  
Submittal Schedule  
3.10.2, 3.12.5, 4.2.7  
**Subrogation, Waivers of**  
6.1.1, 11.3.7  
**Substantial Completion**  
4.2.9, 8.1.1, 8.1.3, 8.2.3, 9.4.2, 9.8, 9.9.1, 9.10.3,  
12.2, 13.7  
**Substantial Completion, Definition of**  
9.8.1  
Substitution of Subcontractors  
5.2.3, 5.2.4  
Substitution of Architect  
4.1.3  
Substitutions of Materials  
3.4.2, 3.5, 7.3.8  
**Sub-subcontractor, Definition of**  
5.1.2  
Subsurface Conditions  
3.7.4  
**Successors and Assigns**  
13.2  
**Superintendent**  
3.9, 10.2.6  
**Supervision and Construction Procedures**  
1.2.2, 3.3, 3.4, 3.12.10, 4.2.2, 4.2.7, 6.1.3, 6.2.4,  
7.1.3, 7.3.7, 8.2, 8.3.1, 9.4.2, 10, 12, 14, 15.1.3  
Surety  
5.4.1.2, 9.8.5, 9.10.2, 9.10.3, 14.2.2, 15.2.7  
Surety, Consent of  
9.10.2, 9.10.3  
Surveys  
2.2.3  
**Suspension by the Owner for Convenience**  
14.3  
Suspension of the Work  
5.4.2, 14.3  
Suspension or Termination of the Contract  
5.4.1.1, 14  
**Taxes**  
3.6, 3.8.2.1, 7.3.7.4  
**Termination by the Contractor**  
14.1, 15.1.6  
**Termination by the Owner for Cause**  
5.4.1.1, 14.2, 15.1.6  
**Termination by the Owner for Convenience**  
14.4  
Termination of the Architect  
4.1.3  
Termination of the Contractor  
14.2.2  
**TERMINATION OR SUSPENSION OF THE CONTRACT**  
14

**Tests and Inspections**  
3.1.3, 3.3.3, 4.2.2, 4.2.6, 4.2.9, 9.4.2, 9.8.3, 9.9.2,  
9.10.1, 10.3.2, 11.4.1, 12.2.1, 13.5  
**TIME**  
8  
**Time, Delays and Extensions of**  
3.2.4, 3.7.4, 5.2.3, 7.2.1, 7.3.1, 7.4, 8.3, 9.5.1, 9.7,  
10.3.2, 10.4, 14.3.2, 15.1.5, 15.2.5  
Time Limits  
2.1.2, 2.2, 2.4, 3.2.2, 3.10, 3.11, 3.12.5, 3.15.1, 4.2,  
5.2, 5.3, 5.4, 6.2.4, 7.3, 7.4, 8.2, 9.2, 9.3.1, 9.3.3,  
9.4.1, 9.5, 9.6, 9.7, 9.8, 9.9, 9.10, 11.1.3, 12.2, 13.5,  
13.7, 14, 15.1.2, 15.4  
**Time Limits on Claims**  
3.7.4, 10.2.8, 13.7, 15.1.2  
Title to Work  
9.3.2, 9.3.3  
**Transmission of Data in Digital Form**  
1.6  
**UNCOVERING AND CORRECTION OF WORK**  
12  
**Uncovering of Work**  
12.1  
Unforeseen Conditions, Concealed or Unknown  
3.7.4, 8.3.1, 10.3  
Unit Prices  
7.3.3.2, 7.3.4  
Use of Documents  
1.1.1, 1.5, 2.2.5, 3.12.6, 5.3  
**Use of Site**  
3.13, 6.1.1, 6.2.1  
**Values, Schedule of**  
9.2, 9.3.1  
Waiver of Claims by the Architect  
13.4.2  
Waiver of Claims by the Contractor  
9.10.5, 13.4.2, 15.1.6  
Waiver of Claims by the Owner  
9.9.3, 9.10.3, 9.10.4, 12.2.2.1, 13.4.2, 14.2.4, 15.1.6  
Waiver of Consequential Damages  
14.2.4, 15.1.6  
Waiver of Liens  
9.10.2, 9.10.4  
**Waivers of Subrogation**  
6.1.1, 11.3.7  
**Warranty**  
3.5, 4.2.9, 9.3.3, 9.8.4, 9.9.1, 9.10.4, 12.2.2, 13.7  
Weather Delays  
15.1.5.2  
**Work, Definition of**  
1.1.3  
Written Consent  
1.5.2, 3.4.2, 3.7.4, 3.12.8, 3.14.2, 4.1.2, 9.3.2, 9.8.5,  
9.9.1, 9.10.2, 9.10.3, 11.4.1, 13.2, 13.4.2, 15.4.4.2  
Written Interpretations  
4.2.11, 4.2.12

Written Notice

2.3, 2.4, 3.3.1, 3.9, 3.12.9, 3.12.10, 5.2.1, 8.2.2, 9.7,  
9.10, 10.2.2, 10.3, 11.1.3, 12.2.2, 12.2.4, 13.3, 14,  
15.4.1

Written Orders

1.1.1, 2.3, 3.9, 7, 8.2.2, 12.1, 12.2, 13.5.2, 14.3.1,  
15.1.2

DRAFT



## **ARTICLE 1 GENERAL PROVISIONS**

### **§ 1.1 BASIC DEFINITIONS**

#### **§ 1.1.1 THE CONTRACT DOCUMENTS**

The Contract Documents are enumerated in the Agreement between the Owner and Contractor (hereinafter the Agreement) and consist of the Agreement, Conditions of the Contract (General, Supplementary and other Conditions), Drawings, Specifications, Addenda issued prior to execution of the Contract, other documents listed in the Agreement and Modifications issued after execution of the Contract. A Modification is (1) a written amendment to the Contract signed by both parties, (2) a Change Order, (3) a Construction Change Directive or (4) a written order for a minor change in the Work issued by the Architect. Unless specifically enumerated in the Agreement, the Contract Documents do not include the advertisement or invitation to bid, Instructions to Bidders, sample forms, other information furnished by the Owner in anticipation of receiving bids or proposals, the Contractor's bid or proposal, or portions of Addenda relating to bidding requirements.

#### **§ 1.1.2 THE CONTRACT**

The Contract Documents form the Contract for Construction. The Contract represents the entire and integrated agreement between the parties hereto and supersedes prior negotiations, representations or agreements, either written or oral. The Contract may be amended or modified only by a Modification. The Contract Documents shall not be construed to create a contractual relationship of any kind (1) between the Contractor and the Architect or the Architect's consultants, (2) between the Owner and a Subcontractor or a Sub-subcontractor, (3) between the Owner and the Architect or the Architect's consultants or (4) between any persons or entities other than the Owner and the Contractor. The Architect shall, however, be entitled to performance and enforcement of obligations under the Contract intended to facilitate performance of the Architect's duties.

#### **§ 1.1.3 THE WORK**

The term "Work" means the construction and services required by the Contract Documents, whether completed or partially completed, and includes all other labor, materials, equipment and services provided or to be provided by the Contractor to fulfill the Contractor's obligations. The Work may constitute the whole or a part of the Project.

#### **§ 1.1.4 THE PROJECT**

The Project is the total construction of which the Work performed under the Contract Documents may be the whole or a part and which may include construction by the Owner and by separate contractors.

#### **§ 1.1.5 THE DRAWINGS**

The Drawings are the graphic and pictorial portions of the Contract Documents showing the design, location and dimensions of the Work, generally including plans, elevations, sections, details, schedules and diagrams.

#### **§ 1.1.6 THE SPECIFICATIONS**

The Specifications are that portion of the Contract Documents consisting of the written requirements for materials, equipment, systems, standards and workmanship for the Work, and performance of related services.

#### **§ 1.1.7 INSTRUMENTS OF SERVICE**

Instruments of Service are representations, in any medium of expression now known or later developed, of the tangible and intangible creative work performed by the Architect and the Architect's consultants under their respective professional services agreements. Instruments of Service may include, without limitation, studies, surveys, models, sketches, drawings, specifications, and other similar materials.

#### **§ 1.1.8 INITIAL DECISION MAKER**

The Initial Decision Maker is the person identified in the Agreement to render initial decisions on Claims in accordance with Section 15.2 and certify termination of the Agreement under Section 14.2.2.

### **§ 1.2 CORRELATION AND INTENT OF THE CONTRACT DOCUMENTS**

**§ 1.2.1** The intent of the Contract Documents is to include all items necessary for the proper execution and completion of the Work by the Contractor. The Contract Documents are complementary, and what is required by one shall be as binding as if required by all; performance by the Contractor shall be required only to the extent consistent with the Contract Documents and reasonably inferable from them as being necessary to produce the indicated results.



**§ 1.2.2** Organization of the Specifications into divisions, sections and articles, and arrangement of Drawings shall not control the Contractor in dividing the Work among Subcontractors or in establishing the extent of Work to be performed by any trade.

**§ 1.2.3** Unless otherwise stated in the Contract Documents, words that have well-known technical or construction industry meanings are used in the Contract Documents in accordance with such recognized meanings.

### **§ 1.3 CAPITALIZATION**

Terms capitalized in these General Conditions include those that are (1) specifically defined, (2) the titles of numbered articles or (3) the titles of other documents published by the American Institute of Architects.

### **§ 1.4 INTERPRETATION**

In the interest of brevity the Contract Documents frequently omit modifying words such as “all” and “any” and articles such as “the” and “an,” but the fact that a modifier or an article is absent from one statement and appears in another is not intended to affect the interpretation of either statement.

### **§ 1.5 OWNERSHIP AND USE OF DRAWINGS, SPECIFICATIONS AND OTHER INSTRUMENTS OF SERVICE**

**§ 1.5.1** The Architect and the Architect’s consultants shall be deemed the authors and owners of their respective Instruments of Service, including the Drawings and Specifications, and will retain all common law, statutory and other reserved rights, including copyrights. The Contractor, Subcontractors, Sub-subcontractors, and material or equipment suppliers shall not own or claim a copyright in the Instruments of Service. Submittal or distribution to meet official regulatory requirements or for other purposes in connection with this Project is not to be construed as publication in derogation of the Architect’s or Architect’s consultants’ reserved rights.

**§ 1.5.2** The Contractor, Subcontractors, Sub-subcontractors and material or equipment suppliers are authorized to use and reproduce the Instruments of Service provided to them solely and exclusively for execution of the Work. All copies made under this authorization shall bear the copyright notice, if any, shown on the Instruments of Service. The Contractor, Subcontractors, Sub-subcontractors, and material or equipment suppliers may not use the Instruments of Service on other projects or for additions to this Project outside the scope of the Work without the specific written consent of the Owner, Architect and the Architect’s consultants.

### **§ 1.6 TRANSMISSION OF DATA IN DIGITAL FORM**

If the parties intend to transmit Instruments of Service or any other information or documentation in digital form, they shall endeavor to establish necessary protocols governing such transmissions, unless otherwise already provided in the Agreement or the Contract Documents.

## **ARTICLE 2 OWNER**

### **§ 2.1 GENERAL**

**§ 2.1.1** The Owner is the person or entity identified as such in the Agreement and is referred to throughout the Contract Documents as if singular in number. The Owner shall designate in writing a representative who shall have express authority to bind the Owner with respect to all matters requiring the Owner’s approval or authorization. Except as otherwise provided in Section 4.2.1, the Architect does not have such authority. The term “Owner” means the Owner or the Owner’s authorized representative.

**§ 2.1.2** The Owner shall furnish to the Contractor within fifteen days after receipt of a written request, information necessary and relevant for the Contractor to evaluate, give notice of or enforce mechanic’s lien rights. Such information shall include a correct statement of the record legal title to the property on which the Project is located, usually referred to as the site, and the Owner’s interest therein.

### **§ 2.2 INFORMATION AND SERVICES REQUIRED OF THE OWNER**

**§ 2.2.1** Prior to commencement of the Work, the Contractor may request in writing that the Owner provide reasonable evidence that the Owner has made financial arrangements to fulfill the Owner’s obligations under the Contract. Thereafter, the Contractor may only request such evidence if (1) the Owner fails to make payments to the Contractor as the Contract Documents require; (2) a change in the Work materially changes the Contract Sum; or (3) the Contractor identifies in writing a reasonable concern regarding the Owner’s ability to make payment when due. The Owner shall furnish such evidence as a condition precedent to commencement or continuation of the Work or



the portion of the Work affected by a material change. After the Owner furnishes the evidence, the Owner shall not materially vary such financial arrangements without prior notice to the Contractor.

§ 2.2.2 Except for permits and fees that are the responsibility of the Contractor under the Contract Documents, including those required under Section 3.7.1, the Owner shall secure and pay for necessary approvals, easements, assessments and charges required for construction, use or occupancy of permanent structures or for permanent changes in existing facilities.

§ 2.2.3 The Owner shall furnish surveys describing physical characteristics, legal limitations and utility locations for the site of the Project, and a legal description of the site. The Contractor shall be entitled to rely on the accuracy of information furnished by the Owner but shall exercise proper precautions relating to the safe performance of the Work.

§ 2.2.4 The Owner shall furnish information or services required of the Owner by the Contract Documents with reasonable promptness. The Owner shall also furnish any other information or services under the Owner's control and relevant to the Contractor's performance of the Work with reasonable promptness after receiving the Contractor's written request for such information or services.

§ 2.2.5 Unless otherwise provided in the Contract Documents, the Owner shall furnish to the Contractor one copy of the Contract Documents for purposes of making reproductions pursuant to Section 1.5.2.

### § 2.3 OWNER'S RIGHT TO STOP THE WORK

If the Contractor fails to correct Work that is not in accordance with the requirements of the Contract Documents as required by Section 12.2 or repeatedly fails to carry out Work in accordance with the Contract Documents, the Owner may issue a written order to the Contractor to stop the Work, or any portion thereof, until the cause for such order has been eliminated; however, the right of the Owner to stop the Work shall not give rise to a duty on the part of the Owner to exercise this right for the benefit of the Contractor or any other person or entity, except to the extent required by Section 6.1.3.

### § 2.4 OWNER'S RIGHT TO CARRY OUT THE WORK

If the Contractor defaults or neglects to carry out the Work in accordance with the Contract Documents and fails within a ten-day period after receipt of written notice from the Owner to commence and continue correction of such default or neglect with diligence and promptness, the Owner may, without prejudice to other remedies the Owner may have, correct such deficiencies. In such case an appropriate Change Order shall be issued deducting from payments then or thereafter due the Contractor the reasonable cost of correcting such deficiencies, including Owner's expenses and compensation for the Architect's additional services made necessary by such default, neglect or failure. Such action by the Owner and amounts charged to the Contractor are both subject to prior approval of the Architect. If payments then or thereafter due the Contractor are not sufficient to cover such amounts, the Contractor shall pay the difference to the Owner.

## ARTICLE 3 CONTRACTOR

### § 3.1 GENERAL

§ 3.1.1 The Contractor is the person or entity identified as such in the Agreement and is referred to throughout the Contract Documents as if singular in number. The Contractor shall be lawfully licensed, if required in the jurisdiction where the Project is located. The Contractor shall designate in writing a representative who shall have express authority to bind the Contractor with respect to all matters under this Contract. The term "Contractor" means the Contractor or the Contractor's authorized representative.

§ 3.1.2 The Contractor shall perform the Work in accordance with the Contract Documents.

§ 3.1.3 The Contractor shall not be relieved of obligations to perform the Work in accordance with the Contract Documents either by activities or duties of the Architect in the Architect's administration of the Contract, or by tests, inspections or approvals required or performed by persons or entities other than the Contractor.



### **§ 3.2 REVIEW OF CONTRACT DOCUMENTS AND FIELD CONDITIONS BY CONTRACTOR**

**§ 3.2.1** Execution of the Contract by the Contractor is a representation that the Contractor has visited the site, become generally familiar with local conditions under which the Work is to be performed and correlated personal observations with requirements of the Contract Documents.

**§ 3.2.2** Because the Contract Documents are complementary, the Contractor shall, before starting each portion of the Work, carefully study and compare the various Contract Documents relative to that portion of the Work, as well as the information furnished by the Owner pursuant to Section 2.2.3, shall take field measurements of any existing conditions related to that portion of the Work, and shall observe any conditions at the site affecting it. These obligations are for the purpose of facilitating coordination and construction by the Contractor and are not for the purpose of discovering errors, omissions, or inconsistencies in the Contract Documents; however, the Contractor shall promptly report to the Architect any errors, inconsistencies or omissions discovered by or made known to the Contractor as a request for information in such form as the Architect may require. It is recognized that the Contractor's review is made in the Contractor's capacity as a contractor and not as a licensed design professional, unless otherwise specifically provided in the Contract Documents.

**§ 3.2.3** The Contractor is not required to ascertain that the Contract Documents are in accordance with applicable laws, statutes, ordinances, codes, rules and regulations, or lawful orders of public authorities, but the Contractor shall promptly report to the Architect any nonconformity discovered by or made known to the Contractor as a request for information in such form as the Architect may require.

**§ 3.2.4** If the Contractor believes that additional cost or time is involved because of clarifications or instructions the Architect issues in response to the Contractor's notices or requests for information pursuant to Sections 3.2.2 or 3.2.3, the Contractor shall make Claims as provided in Article 15. If the Contractor fails to perform the obligations of Sections 3.2.2 or 3.2.3, the Contractor shall pay such costs and damages to the Owner as would have been avoided if the Contractor had performed such obligations. If the Contractor performs those obligations, the Contractor shall not be liable to the Owner or Architect for damages resulting from errors, inconsistencies or omissions in the Contract Documents, for differences between field measurements or conditions and the Contract Documents, or for nonconformities of the Contract Documents to applicable laws, statutes, ordinances, codes, rules and regulations, and lawful orders of public authorities.

### **§ 3.3 SUPERVISION AND CONSTRUCTION PROCEDURES**

**§ 3.3.1** The Contractor shall supervise and direct the Work, using the Contractor's best skill and attention. The Contractor shall be solely responsible for, and have control over, construction means, methods, techniques, sequences and procedures and for coordinating all portions of the Work under the Contract, unless the Contract Documents give other specific instructions concerning these matters. If the Contract Documents give specific instructions concerning construction means, methods, techniques, sequences or procedures, the Contractor shall evaluate the jobsite safety thereof and, except as stated below, shall be fully and solely responsible for the jobsite safety of such means, methods, techniques, sequences or procedures. If the Contractor determines that such means, methods, techniques, sequences or procedures may not be safe, the Contractor shall give timely written notice to the Owner and Architect and shall not proceed with that portion of the Work without further written instructions from the Architect. If the Contractor is then instructed to proceed with the required means, methods, techniques, sequences or procedures without acceptance of changes proposed by the Contractor, the Owner shall be solely responsible for any loss or damage arising solely from those Owner-required means, methods, techniques, sequences or procedures.

**§ 3.3.2** The Contractor shall be responsible to the Owner for acts and omissions of the Contractor's employees, Subcontractors and their agents and employees, and other persons or entities performing portions of the Work for, or on behalf of, the Contractor or any of its Subcontractors.

**§ 3.3.3** The Contractor shall be responsible for inspection of portions of Work already performed to determine that such portions are in proper condition to receive subsequent Work.

### **§ 3.4 LABOR AND MATERIALS**

**§ 3.4.1** Unless otherwise provided in the Contract Documents, the Contractor shall provide and pay for labor, materials, equipment, tools, construction equipment and machinery, water, heat, utilities, transportation, and other



facilities and services necessary for proper execution and completion of the Work, whether temporary or permanent and whether or not incorporated or to be incorporated in the Work.

**§ 3.4.2** Except in the case of minor changes in the Work authorized by the Architect in accordance with Sections 3.12.8 or 7.4, the Contractor may make substitutions only with the consent of the Owner, after evaluation by the Architect and in accordance with a Change Order or Construction Change Directive.

**§ 3.4.3** The Contractor shall enforce strict discipline and good order among the Contractor's employees and other persons carrying out the Work. The Contractor shall not permit employment of unfit persons or persons not properly skilled in tasks assigned to them.

### **§ 3.5 WARRANTY**

The Contractor warrants to the Owner and Architect that materials and equipment furnished under the Contract will be of good quality and new unless the Contract Documents require or permit otherwise. The Contractor further warrants that the Work will conform to the requirements of the Contract Documents and will be free from defects, except for those inherent in the quality of the Work the Contract Documents require or permit. Work, materials, or equipment not conforming to these requirements may be considered defective. The Contractor's warranty excludes remedy for damage or defect caused by abuse, alterations to the Work not executed by the Contractor, improper or insufficient maintenance, improper operation, or normal wear and tear and normal usage. If required by the Architect, the Contractor shall furnish satisfactory evidence as to the kind and quality of materials and equipment.

### **§ 3.6 TAXES**

The Contractor shall pay sales, consumer, use and similar taxes for the Work provided by the Contractor that are legally enacted when bids are received or negotiations concluded, whether or not yet effective or merely scheduled to go into effect.

### **§ 3.7 PERMITS, FEES, NOTICES AND COMPLIANCE WITH LAWS**

**§ 3.7.1** Unless otherwise provided in the Contract Documents, the Contractor shall secure and pay for the building permit as well as for other permits, fees, licenses, and inspections by government agencies necessary for proper execution and completion of the Work that are customarily secured after execution of the Contract and legally required at the time bids are received or negotiations concluded.

**§ 3.7.2** The Contractor shall comply with and give notices required by applicable laws, statutes, ordinances, codes, rules and regulations, and lawful orders of public authorities applicable to performance of the Work.

**§ 3.7.3** If the Contractor performs Work knowing it to be contrary to applicable laws, statutes, ordinances, codes, rules and regulations, or lawful orders of public authorities, the Contractor shall assume appropriate responsibility for such Work and shall bear the costs attributable to correction.

**§ 3.7.4 Concealed or Unknown Conditions.** If the Contractor encounters conditions at the site that are (1) subsurface or otherwise concealed physical conditions that differ materially from those indicated in the Contract Documents or (2) unknown physical conditions of an unusual nature, that differ materially from those ordinarily found to exist and generally recognized as inherent in construction activities of the character provided for in the Contract Documents, the Contractor shall promptly provide notice to the Owner and the Architect before conditions are disturbed and in no event later than 21 days after first observance of the conditions. The Architect will promptly investigate such conditions and, if the Architect determines that they differ materially and cause an increase or decrease in the Contractor's cost of, or time required for, performance of any part of the Work, will recommend an equitable adjustment in the Contract Sum or Contract Time, or both. If the Architect determines that the conditions at the site are not materially different from those indicated in the Contract Documents and that no change in the terms of the Contract is justified, the Architect shall promptly notify the Owner and Contractor in writing, stating the reasons. If either party disputes the Architect's determination or recommendation, that party may proceed as provided in Article 15.

**§ 3.7.5** If, in the course of the Work, the Contractor encounters human remains or recognizes the existence of burial markers, archaeological sites or wetlands not indicated in the Contract Documents, the Contractor shall immediately suspend any operations that would affect them and shall notify the Owner and Architect. Upon receipt of such notice, the Owner shall promptly take any action necessary to obtain governmental authorization required to resume



the operations. The Contractor shall continue to suspend such operations until otherwise instructed by the Owner but shall continue with all other operations that do not affect those remains or features. Requests for adjustments in the Contract Sum and Contract Time arising from the existence of such remains or features may be made as provided in Article 15.

### **§ 3.8 ALLOWANCES**

**§ 3.8.1** The Contractor shall include in the Contract Sum all allowances stated in the Contract Documents. Items covered by allowances shall be supplied for such amounts and by such persons or entities as the Owner may direct, but the Contractor shall not be required to employ persons or entities to whom the Contractor has reasonable objection.

**§ 3.8.2** Unless otherwise provided in the Contract Documents,

- .1 Allowances shall cover the cost to the Contractor of materials and equipment delivered at the site and all required taxes, less applicable trade discounts;
- .2 Contractor's costs for unloading and handling at the site, labor, installation costs, overhead, profit and other expenses contemplated for stated allowance amounts shall be included in the Contract Sum but not in the allowances; and
- .3 Whenever costs are more than or less than allowances, the Contract Sum shall be adjusted accordingly by Change Order. The amount of the Change Order shall reflect (1) the difference between actual costs and the allowances under Section 3.8.2.1 and (2) changes in Contractor's costs under Section 3.8.2.2.

**§ 3.8.3** Materials and equipment under an allowance shall be selected by the Owner with reasonable promptness.

### **§ 3.9 SUPERINTENDENT**

**§ 3.9.1** The Contractor shall employ a competent superintendent and necessary assistants who shall be in attendance at the Project site during performance of the Work. The superintendent shall represent the Contractor, and communications given to the superintendent shall be as binding as if given to the Contractor.

**§ 3.9.2** The Contractor, as soon as practicable after award of the Contract, shall furnish in writing to the Owner through the Architect the name and qualifications of a proposed superintendent. The Architect may reply within 14 days to the Contractor in writing stating (1) whether the Owner or the Architect has reasonable objection to the proposed superintendent or (2) that the Architect requires additional time to review. Failure of the Architect to reply within the 14 day period shall constitute notice of no reasonable objection.

**§ 3.9.3** The Contractor shall not employ a proposed superintendent to whom the Owner or Architect has made reasonable and timely objection. The Contractor shall not change the superintendent without the Owner's consent, which shall not unreasonably be withheld or delayed.

### **§ 3.10 CONTRACTOR'S CONSTRUCTION SCHEDULES**

**§ 3.10.1** The Contractor, promptly after being awarded the Contract, shall prepare and submit for the Owner's and Architect's information a Contractor's construction schedule for the Work. The schedule shall not exceed time limits current under the Contract Documents, shall be revised at appropriate intervals as required by the conditions of the Work and Project, shall be related to the entire Project to the extent required by the Contract Documents, and shall provide for expeditious and practicable execution of the Work.

**§ 3.10.2** The Contractor shall prepare a submittal schedule, promptly after being awarded the Contract and thereafter as necessary to maintain a current submittal schedule, and shall submit the schedule(s) for the Architect's approval. The Architect's approval shall not unreasonably be delayed or withheld. The submittal schedule shall (1) be coordinated with the Contractor's construction schedule, and (2) allow the Architect reasonable time to review submittals. If the Contractor fails to submit a submittal schedule, the Contractor shall not be entitled to any increase in Contract Sum or extension of Contract Time based on the time required for review of submittals.

**§ 3.10.3** The Contractor shall perform the Work in general accordance with the most recent schedules submitted to the Owner and Architect.



### **§ 3.11 DOCUMENTS AND SAMPLES AT THE SITE**

The Contractor shall maintain at the site for the Owner one copy of the Drawings, Specifications, Addenda, Change Orders and other Modifications, in good order and marked currently to indicate field changes and selections made during construction, and one copy of approved Shop Drawings, Product Data, Samples and similar required submittals. These shall be available to the Architect and shall be delivered to the Architect for submittal to the Owner upon completion of the Work as a record of the Work as constructed.

### **§ 3.12 SHOP DRAWINGS, PRODUCT DATA AND SAMPLES**

**§ 3.12.1** Shop Drawings are drawings, diagrams, schedules and other data specially prepared for the Work by the Contractor or a Subcontractor, Sub-subcontractor, manufacturer, supplier or distributor to illustrate some portion of the Work.

**§ 3.12.2** Product Data are illustrations, standard schedules, performance charts, instructions, brochures, diagrams and other information furnished by the Contractor to illustrate materials or equipment for some portion of the Work.

**§ 3.12.3** Samples are physical examples that illustrate materials, equipment or workmanship and establish standards by which the Work will be judged.

**§ 3.12.4** Shop Drawings, Product Data, Samples and similar submittals are not Contract Documents. Their purpose is to demonstrate the way by which the Contractor proposes to conform to the information given and the design concept expressed in the Contract Documents for those portions of the Work for which the Contract Documents require submittals. Review by the Architect is subject to the limitations of Section 4.2.7. Informational submittals upon which the Architect is not expected to take responsive action may be so identified in the Contract Documents. Submittals that are not required by the Contract Documents may be returned by the Architect without action.

**§ 3.12.5** The Contractor shall review for compliance with the Contract Documents, approve and submit to the Architect Shop Drawings, Product Data, Samples and similar submittals required by the Contract Documents in accordance with the submittal schedule approved by the Architect or, in the absence of an approved submittal schedule, with reasonable promptness and in such sequence as to cause no delay in the Work or in the activities of the Owner or of separate contractors.

**§ 3.12.6** By submitting Shop Drawings, Product Data, Samples and similar submittals, the Contractor represents to the Owner and Architect that the Contractor has (1) reviewed and approved them, (2) determined and verified materials, field measurements and field construction criteria related thereto, or will do so and (3) checked and coordinated the information contained within such submittals with the requirements of the Work and of the Contract Documents.

**§ 3.12.7** The Contractor shall perform no portion of the Work for which the Contract Documents require submittal and review of Shop Drawings, Product Data, Samples or similar submittals until the respective submittal has been approved by the Architect.

**§ 3.12.8** The Work shall be in accordance with approved submittals except that the Contractor shall not be relieved of responsibility for deviations from requirements of the Contract Documents by the Architect's approval of Shop Drawings, Product Data, Samples or similar submittals unless the Contractor has specifically informed the Architect in writing of such deviation at the time of submittal and (1) the Architect has given written approval to the specific deviation as a minor change in the Work, or (2) a Change Order or Construction Change Directive has been issued authorizing the deviation. The Contractor shall not be relieved of responsibility for errors or omissions in Shop Drawings, Product Data, Samples or similar submittals by the Architect's approval thereof.

**§ 3.12.9** The Contractor shall direct specific attention, in writing or on resubmitted Shop Drawings, Product Data, Samples or similar submittals, to revisions other than those requested by the Architect on previous submittals. In the absence of such written notice, the Architect's approval of a resubmission shall not apply to such revisions.

**§ 3.12.10** The Contractor shall not be required to provide professional services that constitute the practice of architecture or engineering unless such services are specifically required by the Contract Documents for a portion of the Work or unless the Contractor needs to provide such services in order to carry out the Contractor's responsibilities for construction means, methods, techniques, sequences and procedures. The Contractor shall not be



required to provide professional services in violation of applicable law. If professional design services or certifications by a design professional related to systems, materials or equipment are specifically required of the Contractor by the Contract Documents, the Owner and the Architect will specify all performance and design criteria that such services must satisfy. The Contractor shall cause such services or certifications to be provided by a properly licensed design professional, whose signature and seal shall appear on all drawings, calculations, specifications, certifications, Shop Drawings and other submittals prepared by such professional. Shop Drawings and other submittals related to the Work designed or certified by such professional, if prepared by others, shall bear such professional's written approval when submitted to the Architect. The Owner and the Architect shall be entitled to rely upon the adequacy, accuracy and completeness of the services, certifications and approvals performed or provided by such design professionals, provided the Owner and Architect have specified to the Contractor all performance and design criteria that such services must satisfy. Pursuant to this Section 3.12.10, the Architect will review, approve or take other appropriate action on submittals only for the limited purpose of checking for conformance with information given and the design concept expressed in the Contract Documents. The Contractor shall not be responsible for the adequacy of the performance and design criteria specified in the Contract Documents.

### **§ 3.13 USE OF SITE**

The Contractor shall confine operations at the site to areas permitted by applicable laws, statutes, ordinances, codes, rules and regulations, and lawful orders of public authorities and the Contract Documents and shall not unreasonably encumber the site with materials or equipment.

### **§ 3.14 CUTTING AND PATCHING**

**§ 3.14.1** The Contractor shall be responsible for cutting, fitting or patching required to complete the Work or to make its parts fit together properly. All areas requiring cutting, fitting and patching shall be restored to the condition existing prior to the cutting, fitting and patching, unless otherwise required by the Contract Documents.

**§ 3.14.2** The Contractor shall not damage or endanger a portion of the Work or fully or partially completed construction of the Owner or separate contractors by cutting, patching or otherwise altering such construction, or by excavation. The Contractor shall not cut or otherwise alter such construction by the Owner or a separate contractor except with written consent of the Owner and of such separate contractor; such consent shall not be unreasonably withheld. The Contractor shall not unreasonably withhold from the Owner or a separate contractor the Contractor's consent to cutting or otherwise altering the Work.

### **§ 3.15 CLEANING UP**

**§ 3.15.1** The Contractor shall keep the premises and surrounding area free from accumulation of waste materials or rubbish caused by operations under the Contract. At completion of the Work, the Contractor shall remove waste materials, rubbish, the Contractor's tools, construction equipment, machinery and surplus materials from and about the Project.

**§ 3.15.2** If the Contractor fails to clean up as provided in the Contract Documents, the Owner may do so and Owner shall be entitled to reimbursement from the Contractor.

### **§ 3.16 ACCESS TO WORK**

The Contractor shall provide the Owner and Architect access to the Work in preparation and progress wherever located.

### **§ 3.17 ROYALTIES, PATENTS AND COPYRIGHTS**

The Contractor shall pay all royalties and license fees. The Contractor shall defend suits or claims for infringement of copyrights and patent rights and shall hold the Owner and Architect harmless from loss on account thereof, but shall not be responsible for such defense or loss when a particular design, process or product of a particular manufacturer or manufacturers is required by the Contract Documents, or where the copyright violations are contained in Drawings, Specifications or other documents prepared by the Owner or Architect. However, if the Contractor has reason to believe that the required design, process or product is an infringement of a copyright or a patent, the Contractor shall be responsible for such loss unless such information is promptly furnished to the Architect.



### **§ 3.18 INDEMNIFICATION**

**§ 3.18.1** To the fullest extent permitted by law the Contractor shall indemnify and hold harmless the Owner, Architect, Architect's consultants, and agents and employees of any of them from and against claims, damages, losses and expenses, including but not limited to attorneys' fees, arising out of or resulting from performance of the Work, provided that such claim, damage, loss or expense is attributable to bodily injury, sickness, disease or death, or to injury to or destruction of tangible property (other than the Work itself), but only to the extent caused by the negligent acts or omissions of the Contractor, a Subcontractor, anyone directly or indirectly employed by them or anyone for whose acts they may be liable, regardless of whether or not such claim, damage, loss or expense is caused in part by a party indemnified hereunder. Such obligation shall not be construed to negate, abridge, or reduce other rights or obligations of indemnity that would otherwise exist as to a party or person described in this Section 3.18.

**§ 3.18.2** In claims against any person or entity indemnified under this Section 3.18 by an employee of the Contractor, a Subcontractor, anyone directly or indirectly employed by them or anyone for whose acts they may be liable, the indemnification obligation under Section 3.18.1 shall not be limited by a limitation on amount or type of damages, compensation or benefits payable by or for the Contractor or a Subcontractor under workers' compensation acts, disability benefit acts or other employee benefit acts.

## **ARTICLE 4 ARCHITECT**

### **§ 4.1 GENERAL**

**§ 4.1.1** The Owner shall retain an architect lawfully licensed to practice architecture or an entity lawfully practicing architecture in the jurisdiction where the Project is located. That person or entity is identified as the Architect in the Agreement and is referred to throughout the Contract Documents as if singular in number.

**§ 4.1.2** Duties, responsibilities and limitations of authority of the Architect as set forth in the Contract Documents shall not be restricted, modified or extended without written consent of the Owner, Contractor and Architect. Consent shall not be unreasonably withheld.

**§ 4.1.3** If the employment of the Architect is terminated, the Owner shall employ a successor architect as to whom the Contractor has no reasonable objection and whose status under the Contract Documents shall be that of the Architect.

### **§ 4.2 ADMINISTRATION OF THE CONTRACT**

**§ 4.2.1** The Architect will provide administration of the Contract as described in the Contract Documents and will be an Owner's representative during construction until the date the Architect issues the final Certificate for Payment. The Architect will have authority to act on behalf of the Owner only to the extent provided in the Contract Documents.

**§ 4.2.2** The Architect will visit the site at intervals appropriate to the stage of construction, or as otherwise agreed with the Owner, to become generally familiar with the progress and quality of the portion of the Work completed, and to determine in general if the Work observed is being performed in a manner indicating that the Work, when fully completed, will be in accordance with the Contract Documents. However, the Architect will not be required to make exhaustive or continuous on-site inspections to check the quality or quantity of the Work. The Architect will not have control over, charge of, or responsibility for, the construction means, methods, techniques, sequences or procedures, or for the safety precautions and programs in connection with the Work, since these are solely the Contractor's rights and responsibilities under the Contract Documents, except as provided in Section 3.3.1.

**§ 4.2.3** On the basis of the site visits, the Architect will keep the Owner reasonably informed about the progress and quality of the portion of the Work completed, and report to the Owner (1) known deviations from the Contract Documents and from the most recent construction schedule submitted by the Contractor, and (2) defects and deficiencies observed in the Work. The Architect will not be responsible for the Contractor's failure to perform the Work in accordance with the requirements of the Contract Documents. The Architect will not have control over or charge of and will not be responsible for acts or omissions of the Contractor, Subcontractors, or their agents or employees, or any other persons or entities performing portions of the Work.



#### § 4.2.4 COMMUNICATIONS FACILITATING CONTRACT ADMINISTRATION

Except as otherwise provided in the Contract Documents or when direct communications have been specially authorized, the Owner and Contractor shall endeavor to communicate with each other through the Architect about matters arising out of or relating to the Contract. Communications by and with the Architect's consultants shall be through the Architect. Communications by and with Subcontractors and material suppliers shall be through the Contractor. Communications by and with separate contractors shall be through the Owner.

§ 4.2.5 Based on the Architect's evaluations of the Contractor's Applications for Payment, the Architect will review and certify the amounts due the Contractor and will issue Certificates for Payment in such amounts.

§ 4.2.6 The Architect has authority to reject Work that does not conform to the Contract Documents. Whenever the Architect considers it necessary or advisable, the Architect will have authority to require inspection or testing of the Work in accordance with Sections 13.5.2 and 13.5.3, whether or not such Work is fabricated, installed or completed. However, neither this authority of the Architect nor a decision made in good faith either to exercise or not to exercise such authority shall give rise to a duty or responsibility of the Architect to the Contractor, Subcontractors, material and equipment suppliers, their agents or employees, or other persons or entities performing portions of the Work.

§ 4.2.7 The Architect will review and approve, or take other appropriate action upon, the Contractor's submittals such as Shop Drawings, Product Data and Samples, but only for the limited purpose of checking for conformance with information given and the design concept expressed in the Contract Documents. The Architect's action will be taken in accordance with the submittal schedule approved by the Architect or, in the absence of an approved submittal schedule, with reasonable promptness while allowing sufficient time in the Architect's professional judgment to permit adequate review. Review of such submittals is not conducted for the purpose of determining the accuracy and completeness of other details such as dimensions and quantities, or for substantiating instructions for installation or performance of equipment or systems, all of which remain the responsibility of the Contractor as required by the Contract Documents. The Architect's review of the Contractor's submittals shall not relieve the Contractor of the obligations under Sections 3.3, 3.5 and 3.12. The Architect's review shall not constitute approval of safety precautions or, unless otherwise specifically stated by the Architect, of any construction means, methods, techniques, sequences or procedures. The Architect's approval of a specific item shall not indicate approval of an assembly of which the item is a component.

§ 4.2.8 The Architect will prepare Change Orders and Construction Change Directives, and may authorize minor changes in the Work as provided in Section 7.4. The Architect will investigate and make determinations and recommendations regarding concealed and unknown conditions as provided in Section 3.7.4.

§ 4.2.9 The Architect will conduct inspections to determine the date or dates of Substantial Completion and the date of final completion; issue Certificates of Substantial Completion pursuant to Section 9.8; receive and forward to the Owner, for the Owner's review and records, written warranties and related documents required by the Contract and assembled by the Contractor pursuant to Section 9.10; and issue a final Certificate for Payment pursuant to Section 9.10.

§ 4.2.10 If the Owner and Architect agree, the Architect will provide one or more project representatives to assist in carrying out the Architect's responsibilities at the site. The duties, responsibilities and limitations of authority of such project representatives shall be as set forth in an exhibit to be incorporated in the Contract Documents.

§ 4.2.11 The Architect will interpret and decide matters concerning performance under, and requirements of, the Contract Documents on written request of either the Owner or Contractor. The Architect's response to such requests will be made in writing within any time limits agreed upon or otherwise with reasonable promptness.

§ 4.2.12 Interpretations and decisions of the Architect will be consistent with the intent of, and reasonably inferable from, the Contract Documents and will be in writing or in the form of drawings. When making such interpretations and decisions, the Architect will endeavor to secure faithful performance by both Owner and Contractor, will not show partiality to either and will not be liable for results of interpretations or decisions rendered in good faith.

§ 4.2.13 The Architect's decisions on matters relating to aesthetic effect will be final if consistent with the intent expressed in the Contract Documents.



§ 4.2.14 The Architect will review and respond to requests for information about the Contract Documents. The Architect's response to such requests will be made in writing within any time limits agreed upon or otherwise with reasonable promptness. If appropriate, the Architect will prepare and issue supplemental Drawings and Specifications in response to the requests for information.

## ARTICLE 5 SUBCONTRACTORS

### § 5.1 DEFINITIONS

§ 5.1.1 A Subcontractor is a person or entity who has a direct contract with the Contractor to perform a portion of the Work at the site. The term "Subcontractor" is referred to throughout the Contract Documents as if singular in number and means a Subcontractor or an authorized representative of the Subcontractor. The term "Subcontractor" does not include a separate contractor or subcontractors of a separate contractor.

§ 5.1.2 A Sub-subcontractor is a person or entity who has a direct or indirect contract with a Subcontractor to perform a portion of the Work at the site. The term "Sub-subcontractor" is referred to throughout the Contract Documents as if singular in number and means a Sub-subcontractor or an authorized representative of the Sub-subcontractor.

### § 5.2 AWARD OF SUBCONTRACTS AND OTHER CONTRACTS FOR PORTIONS OF THE WORK

§ 5.2.1 Unless otherwise stated in the Contract Documents or the bidding requirements, the Contractor, as soon as practicable after award of the Contract, shall furnish in writing to the Owner through the Architect the names of persons or entities (including those who are to furnish materials or equipment fabricated to a special design) proposed for each principal portion of the Work. The Architect may reply within 14 days to the Contractor in writing stating (1) whether the Owner or the Architect has reasonable objection to any such proposed person or entity or (2) that the Architect requires additional time for review. Failure of the Owner or Architect to reply within the 14-day period shall constitute notice of no reasonable objection.

§ 5.2.2 The Contractor shall not contract with a proposed person or entity to whom the Owner or Architect has made reasonable and timely objection. The Contractor shall not be required to contract with anyone to whom the Contractor has made reasonable objection.

§ 5.2.3 If the Owner or Architect has reasonable objection to a person or entity proposed by the Contractor, the Contractor shall propose another to whom the Owner or Architect has no reasonable objection. If the proposed but rejected Subcontractor was reasonably capable of performing the Work, the Contract Sum and Contract Time shall be increased or decreased by the difference, if any, occasioned by such change, and an appropriate Change Order shall be issued before commencement of the substitute Subcontractor's Work. However, no increase in the Contract Sum or Contract Time shall be allowed for such change unless the Contractor has acted promptly and responsively in submitting names as required.

§ 5.2.4 The Contractor shall not substitute a Subcontractor, person or entity previously selected if the Owner or Architect makes reasonable objection to such substitution.

### § 5.3 SUBCONTRACTUAL RELATIONS

By appropriate agreement, written where legally required for validity, the Contractor shall require each Subcontractor, to the extent of the Work to be performed by the Subcontractor, to be bound to the Contractor by terms of the Contract Documents, and to assume toward the Contractor all the obligations and responsibilities, including the responsibility for safety of the Subcontractor's Work, which the Contractor, by these Documents, assumes toward the Owner and Architect. Each subcontract agreement shall preserve and protect the rights of the Owner and Architect under the Contract Documents with respect to the Work to be performed by the Subcontractor so that subcontracting thereof will not prejudice such rights, and shall allow to the Subcontractor, unless specifically provided otherwise in the subcontract agreement, the benefit of all rights, remedies and redress against the Contractor that the Contractor, by the Contract Documents, has against the Owner. Where appropriate, the Contractor shall require each Subcontractor to enter into similar agreements with Sub-subcontractors. The Contractor shall make available to each proposed Subcontractor, prior to the execution of the subcontract agreement, copies of the Contract Documents to which the Subcontractor will be bound, and, upon written request of the Subcontractor, identify to the Subcontractor terms and conditions of the proposed subcontract agreement that may



be at variance with the Contract Documents. Subcontractors will similarly make copies of applicable portions of such documents available to their respective proposed Sub-subcontractors.

#### **§ 5.4 CONTINGENT ASSIGNMENT OF SUBCONTRACTS**

**§ 5.4.1** Each subcontract agreement for a portion of the Work is assigned by the Contractor to the Owner, provided that

- .1 assignment is effective only after termination of the Contract by the Owner for cause pursuant to Section 14.2 and only for those subcontract agreements that the Owner accepts by notifying the Subcontractor and Contractor in writing; and
- .2 assignment is subject to the prior rights of the surety, if any, obligated under bond relating to the Contract.

When the Owner accepts the assignment of a subcontract agreement, the Owner assumes the Contractor's rights and obligations under the subcontract.

**§ 5.4.2** Upon such assignment, if the Work has been suspended for more than 30 days, the Subcontractor's compensation shall be equitably adjusted for increases in cost resulting from the suspension.

**§ 5.4.3** Upon such assignment to the Owner under this Section 5.4, the Owner may further assign the subcontract to a successor contractor or other entity. If the Owner assigns the subcontract to a successor contractor or other entity, the Owner shall nevertheless remain legally responsible for all of the successor contractor's obligations under the subcontract.

### **ARTICLE 6 CONSTRUCTION BY OWNER OR BY SEPARATE CONTRACTORS**

#### **§ 6.1 OWNER'S RIGHT TO PERFORM CONSTRUCTION AND TO AWARD SEPARATE CONTRACTS**

**§ 6.1.1** The Owner reserves the right to perform construction or operations related to the Project with the Owner's own forces, and to award separate contracts in connection with other portions of the Project or other construction or operations on the site under Conditions of the Contract identical or substantially similar to these including those portions related to insurance and waiver of subrogation. If the Contractor claims that delay or additional cost is involved because of such action by the Owner, the Contractor shall make such Claim as provided in Article 15.

**§ 6.1.2** When separate contracts are awarded for different portions of the Project or other construction or operations on the site, the term "Contractor" in the Contract Documents in each case shall mean the Contractor who executes each separate Owner-Contractor Agreement.

**§ 6.1.3** The Owner shall provide for coordination of the activities of the Owner's own forces and of each separate contractor with the Work of the Contractor, who shall cooperate with them. The Contractor shall participate with other separate contractors and the Owner in reviewing their construction schedules. The Contractor shall make any revisions to the construction schedule deemed necessary after a joint review and mutual agreement. The construction schedules shall then constitute the schedules to be used by the Contractor, separate contractors and the Owner until subsequently revised.

**§ 6.1.4** Unless otherwise provided in the Contract Documents, when the Owner performs construction or operations related to the Project with the Owner's own forces, the Owner shall be deemed to be subject to the same obligations and to have the same rights that apply to the Contractor under the Conditions of the Contract, including, without excluding others, those stated in Article 3, this Article 6 and Articles 10, 11 and 12.

#### **§ 6.2 MUTUAL RESPONSIBILITY**

**§ 6.2.1** The Contractor shall afford the Owner and separate contractors reasonable opportunity for introduction and storage of their materials and equipment and performance of their activities, and shall connect and coordinate the Contractor's construction and operations with theirs as required by the Contract Documents.

**§ 6.2.2** If part of the Contractor's Work depends for proper execution or results upon construction or operations by the Owner or a separate contractor, the Contractor shall, prior to proceeding with that portion of the Work, promptly report to the Architect apparent discrepancies or defects in such other construction that would render it unsuitable for such proper execution and results. Failure of the Contractor so to report shall constitute an acknowledgment that



the Owner's or separate contractor's completed or partially completed construction is fit and proper to receive the Contractor's Work, except as to defects not then reasonably discoverable.

§ 6.2.3 The Contractor shall reimburse the Owner for costs the Owner incurs that are payable to a separate contractor because of the Contractor's delays, improperly timed activities or defective construction. The Owner shall be responsible to the Contractor for costs the Contractor incurs because of a separate contractor's delays, improperly timed activities, damage to the Work or defective construction.

§ 6.2.4 The Contractor shall promptly remedy damage the Contractor wrongfully causes to completed or partially completed construction or to property of the Owner or separate contractors as provided in Section 10.2.5.

§ 6.2.5 The Owner and each separate contractor shall have the same responsibilities for cutting and patching as are described for the Contractor in Section 3.14.

### § 6.3 OWNER'S RIGHT TO CLEAN UP

If a dispute arises among the Contractor, separate contractors and the Owner as to the responsibility under their respective contracts for maintaining the premises and surrounding area free from waste materials and rubbish, the Owner may clean up and the Architect will allocate the cost among those responsible.

## ARTICLE 7 CHANGES IN THE WORK

### § 7.1 GENERAL

§ 7.1.1 Changes in the Work may be accomplished after execution of the Contract, and without invalidating the Contract, by Change Order, Construction Change Directive or order for a minor change in the Work, subject to the limitations stated in this Article 7 and elsewhere in the Contract Documents.

§ 7.1.2 A Change Order shall be based upon agreement among the Owner, Contractor and Architect; a Construction Change Directive requires agreement by the Owner and Architect and may or may not be agreed to by the Contractor; an order for a minor change in the Work may be issued by the Architect alone.

§ 7.1.3 Changes in the Work shall be performed under applicable provisions of the Contract Documents, and the Contractor shall proceed promptly, unless otherwise provided in the Change Order, Construction Change Directive or order for a minor change in the Work.

### § 7.2 CHANGE ORDERS

§ 7.2.1 A Change Order is a written instrument prepared by the Architect and signed by the Owner, Contractor and Architect stating their agreement upon all of the following:

- .1 The change in the Work;
- .2 The amount of the adjustment, if any, in the Contract Sum; and
- .3 The extent of the adjustment, if any, in the Contract Time.

### § 7.3 CONSTRUCTION CHANGE DIRECTIVES

§ 7.3.1 A Construction Change Directive is a written order prepared by the Architect and signed by the Owner and Architect, directing a change in the Work prior to agreement on adjustment, if any, in the Contract Sum or Contract Time, or both. The Owner may by Construction Change Directive, without invalidating the Contract, order changes in the Work within the general scope of the Contract consisting of additions, deletions or other revisions, the Contract Sum and Contract Time being adjusted accordingly.

§ 7.3.2 A Construction Change Directive shall be used in the absence of total agreement on the terms of a Change Order.

§ 7.3.3 If the Construction Change Directive provides for an adjustment to the Contract Sum, the adjustment shall be based on one of the following methods:

- .1 Mutual acceptance of a lump sum properly itemized and supported by sufficient substantiating data to permit evaluation;
- .2 Unit prices stated in the Contract Documents or subsequently agreed upon;
- .3 Cost to be determined in a manner agreed upon by the parties and a mutually acceptable fixed or percentage fee; or



.4 As provided in Section 7.3.7.

§ 7.3.4 If unit prices are stated in the Contract Documents or subsequently agreed upon, and if quantities originally contemplated are materially changed in a proposed Change Order or Construction Change Directive so that application of such unit prices to quantities of Work proposed will cause substantial inequity to the Owner or Contractor, the applicable unit prices shall be equitably adjusted.

§ 7.3.5 Upon receipt of a Construction Change Directive, the Contractor shall promptly proceed with the change in the Work involved and advise the Architect of the Contractor's agreement or disagreement with the method, if any, provided in the Construction Change Directive for determining the proposed adjustment in the Contract Sum or Contract Time.

§ 7.3.6 A Construction Change Directive signed by the Contractor indicates the Contractor's agreement therewith, including adjustment in Contract Sum and Contract Time or the method for determining them. Such agreement shall be effective immediately and shall be recorded as a Change Order.

§ 7.3.7 If the Contractor does not respond promptly or disagrees with the method for adjustment in the Contract Sum, the Architect shall determine the method and the adjustment on the basis of reasonable expenditures and savings of those performing the Work attributable to the change, including, in case of an increase in the Contract Sum, an amount for overhead and profit as set forth in the Agreement, or if no such amount is set forth in the Agreement, a reasonable amount. In such case, and also under Section 7.3.3.3, the Contractor shall keep and present, in such form as the Architect may prescribe, an itemized accounting together with appropriate supporting data. Unless otherwise provided in the Contract Documents, costs for the purposes of this Section 7.3.7 shall be limited to the following:

- .1 Costs of labor, including social security, old age and unemployment insurance, fringe benefits required by agreement or custom, and workers' compensation insurance;
- .2 Costs of materials, supplies and equipment, including cost of transportation, whether incorporated or consumed;
- .3 Rental costs of machinery and equipment, exclusive of hand tools, whether rented from the Contractor or others;
- .4 Costs of premiums for all bonds and insurance, permit fees, and sales, use or similar taxes related to the Work; and
- .5 Additional costs of supervision and field office personnel directly attributable to the change.

§ 7.3.8 The amount of credit to be allowed by the Contractor to the Owner for a deletion or change that results in a net decrease in the Contract Sum shall be actual net cost as confirmed by the Architect. When both additions and credits covering related Work or substitutions are involved in a change, the allowance for overhead and profit shall be figured on the basis of net increase, if any, with respect to that change.

§ 7.3.9 Pending final determination of the total cost of a Construction Change Directive to the Owner, the Contractor may request payment for Work completed under the Construction Change Directive in Applications for Payment. The Architect will make an interim determination for purposes of monthly certification for payment for those costs and certify for payment the amount that the Architect determines, in the Architect's professional judgment, to be reasonably justified. The Architect's interim determination of cost shall adjust the Contract Sum on the same basis as a Change Order, subject to the right of either party to disagree and assert a Claim in accordance with Article 15.

§ 7.3.10 When the Owner and Contractor agree with a determination made by the Architect concerning the adjustments in the Contract Sum and Contract Time, or otherwise reach agreement upon the adjustments, such agreement shall be effective immediately and the Architect will prepare a Change Order. Change Orders may be issued for all or any part of a Construction Change Directive.

#### § 7.4 MINOR CHANGES IN THE WORK

The Architect has authority to order minor changes in the Work not involving adjustment in the Contract Sum or extension of the Contract Time and not inconsistent with the intent of the Contract Documents. Such changes will be effected by written order signed by the Architect and shall be binding on the Owner and Contractor.



## **ARTICLE 8 TIME**

### **§ 8.1 DEFINITIONS**

§ 8.1.1 Unless otherwise provided, Contract Time is the period of time, including authorized adjustments, allotted in the Contract Documents for Substantial Completion of the Work.

§ 8.1.2 The date of commencement of the Work is the date established in the Agreement.

§ 8.1.3 The date of Substantial Completion is the date certified by the Architect in accordance with Section 9.8.

§ 8.1.4 The term "day" as used in the Contract Documents shall mean calendar day unless otherwise specifically defined.

### **§ 8.2 PROGRESS AND COMPLETION**

§ 8.2.1 Time limits stated in the Contract Documents are of the essence of the Contract. By executing the Agreement the Contractor confirms that the Contract Time is a reasonable period for performing the Work.

§ 8.2.2 The Contractor shall not knowingly, except by agreement or instruction of the Owner in writing, prematurely commence operations on the site or elsewhere prior to the effective date of insurance required by Article 11 to be furnished by the Contractor and Owner. The date of commencement of the Work shall not be changed by the effective date of such insurance.

§ 8.2.3 The Contractor shall proceed expeditiously with adequate forces and shall achieve Substantial Completion within the Contract Time.

### **§ 8.3 DELAYS AND EXTENSIONS OF TIME**

§ 8.3.1 If the Contractor is delayed at any time in the commencement or progress of the Work by an act or neglect of the Owner or Architect, or of an employee of either, or of a separate contractor employed by the Owner; or by changes ordered in the Work; or by labor disputes, fire, unusual delay in deliveries, unavoidable casualties or other causes beyond the Contractor's control; or by delay authorized by the Owner pending mediation and arbitration; or by other causes that the Architect determines may justify delay, then the Contract Time shall be extended by Change Order for such reasonable time as the Architect may determine.

§ 8.3.2 Claims relating to time shall be made in accordance with applicable provisions of Article 15.

§ 8.3.3 This Section 8.3 does not preclude recovery of damages for delay by either party under other provisions of the Contract Documents.

## **ARTICLE 9 PAYMENTS AND COMPLETION**

### **§ 9.1 CONTRACT SUM**

The Contract Sum is stated in the Agreement and, including authorized adjustments, is the total amount payable by the Owner to the Contractor for performance of the Work under the Contract Documents.

### **§ 9.2 SCHEDULE OF VALUES**

Where the Contract is based on a stipulated sum or Guaranteed Maximum Price, the Contractor shall submit to the Architect, before the first Application for Payment, a schedule of values allocating the entire Contract Sum to the various portions of the Work and prepared in such form and supported by such data to substantiate its accuracy as the Architect may require. This schedule, unless objected to by the Architect, shall be used as a basis for reviewing the Contractor's Applications for Payment.

### **§ 9.3 APPLICATIONS FOR PAYMENT**

§ 9.3.1 At least ten days before the date established for each progress payment, the Contractor shall submit to the Architect an itemized Application for Payment prepared in accordance with the schedule of values, if required under Section 9.2, for completed portions of the Work. Such application shall be notarized, if required, and supported by such data substantiating the Contractor's right to payment as the Owner or Architect may require, such as copies of requisitions from Subcontractors and material suppliers, and shall reflect retainage if provided for in the Contract Documents.



§ 9.3.1.1 As provided in Section 7.3.9, such applications may include requests for payment on account of changes in the Work that have been properly authorized by Construction Change Directives, or by interim determinations of the Architect, but not yet included in Change Orders.

§ 9.3.1.2 Applications for Payment shall not include requests for payment for portions of the Work for which the Contractor does not intend to pay a Subcontractor or material supplier, unless such Work has been performed by others whom the Contractor intends to pay.

§ 9.3.2 Unless otherwise provided in the Contract Documents, payments shall be made on account of materials and equipment delivered and suitably stored at the site for subsequent incorporation in the Work. If approved in advance by the Owner, payment may similarly be made for materials and equipment suitably stored off the site at a location agreed upon in writing. Payment for materials and equipment stored on or off the site shall be conditioned upon compliance by the Contractor with procedures satisfactory to the Owner to establish the Owner's title to such materials and equipment or otherwise protect the Owner's interest, and shall include the costs of applicable insurance, storage and transportation to the site for such materials and equipment stored off the site.

§ 9.3.3 The Contractor warrants that title to all Work covered by an Application for Payment will pass to the Owner no later than the time of payment. The Contractor further warrants that upon submittal of an Application for Payment all Work for which Certificates for Payment have been previously issued and payments received from the Owner shall, to the best of the Contractor's knowledge, information and belief, be free and clear of liens, claims, security interests or encumbrances in favor of the Contractor, Subcontractors, material suppliers, or other persons or entities making a claim by reason of having provided labor, materials and equipment relating to the Work.

#### § 9.4 CERTIFICATES FOR PAYMENT

§ 9.4.1 The Architect will, within seven days after receipt of the Contractor's Application for Payment, either issue to the Owner a Certificate for Payment, with a copy to the Contractor, for such amount as the Architect determines is properly due, or notify the Contractor and Owner in writing of the Architect's reasons for withholding certification in whole or in part as provided in Section 9.5.1.

§ 9.4.2 The issuance of a Certificate for Payment will constitute a representation by the Architect to the Owner, based on the Architect's evaluation of the Work and the data comprising the Application for Payment, that, to the best of the Architect's knowledge, information and belief, the Work has progressed to the point indicated and that the quality of the Work is in accordance with the Contract Documents. The foregoing representations are subject to an evaluation of the Work for conformance with the Contract Documents upon Substantial Completion, to results of subsequent tests and inspections, to correction of minor deviations from the Contract Documents prior to completion and to specific qualifications expressed by the Architect. The issuance of a Certificate for Payment will further constitute a representation that the Contractor is entitled to payment in the amount certified. However, the issuance of a Certificate for Payment will not be a representation that the Architect has (1) made exhaustive or continuous on-site inspections to check the quality or quantity of the Work, (2) reviewed construction means, methods, techniques, sequences or procedures, (3) reviewed copies of requisitions received from Subcontractors and material suppliers and other data requested by the Owner to substantiate the Contractor's right to payment, or (4) made examination to ascertain how or for what purpose the Contractor has used money previously paid on account of the Contract Sum.

#### § 9.5 DECISIONS TO WITHHOLD CERTIFICATION

§ 9.5.1 The Architect may withhold a Certificate for Payment in whole or in part, to the extent reasonably necessary to protect the Owner, if in the Architect's opinion the representations to the Owner required by Section 9.4.2 cannot be made. If the Architect is unable to certify payment in the amount of the Application, the Architect will notify the Contractor and Owner as provided in Section 9.4.1. If the Contractor and Architect cannot agree on a revised amount, the Architect will promptly issue a Certificate for Payment for the amount for which the Architect is able to make such representations to the Owner. The Architect may also withhold a Certificate for Payment or, because of subsequently discovered evidence, may nullify the whole or a part of a Certificate for Payment previously issued, to such extent as may be necessary in the Architect's opinion to protect the Owner from loss for which the Contractor is responsible, including loss resulting from acts and omissions described in Section 3.3.2, because of

- .1 defective Work not remedied;
- .2 third party claims filed or reasonable evidence indicating probable filing of such claims unless security acceptable to the Owner is provided by the Contractor;



- .3 failure of the Contractor to make payments properly to Subcontractors or for labor, materials or equipment;
- .4 reasonable evidence that the Work cannot be completed for the unpaid balance of the Contract Sum;
- .5 damage to the Owner or a separate contractor;
- .6 reasonable evidence that the Work will not be completed within the Contract Time, and that the unpaid balance would not be adequate to cover actual or liquidated damages for the anticipated delay; or
- .7 repeated failure to carry out the Work in accordance with the Contract Documents.

§ 9.5.2 When the above reasons for withholding certification are removed, certification will be made for amounts previously withheld.

§ 9.5.3 If the Architect withholds certification for payment under Section 9.5.1.3, the Owner may, at its sole option, issue joint checks to the Contractor and to any Subcontractor or material or equipment suppliers to whom the Contractor failed to make payment for Work properly performed or material or equipment suitably delivered. If the Owner makes payments by joint check, the Owner shall notify the Architect and the Architect will reflect such payment on the next Certificate for Payment.

### § 9.6 PROGRESS PAYMENTS

§ 9.6.1 After the Architect has issued a Certificate for Payment, the Owner shall make payment in the manner and within the time provided in the Contract Documents, and shall so notify the Architect.

§ 9.6.2 The Contractor shall pay each Subcontractor no later than seven days after receipt of payment from the Owner the amount to which the Subcontractor is entitled, reflecting percentages actually retained from payments to the Contractor on account of the Subcontractor's portion of the Work. The Contractor shall, by appropriate agreement with each Subcontractor, require each Subcontractor to make payments to Sub-subcontractors in a similar manner.

§ 9.6.3 The Architect will, on request, furnish to a Subcontractor, if practicable, information regarding percentages of completion or amounts applied for by the Contractor and action taken thereon by the Architect and Owner on account of portions of the Work done by such Subcontractor.

§ 9.6.4 The Owner has the right to request written evidence from the Contractor that the Contractor has properly paid Subcontractors and material and equipment suppliers amounts paid by the Owner to the Contractor for subcontracted Work. If the Contractor fails to furnish such evidence within seven days, the Owner shall have the right to contact Subcontractors to ascertain whether they have been properly paid. Neither the Owner nor Architect shall have an obligation to pay or to see to the payment of money to a Subcontractor, except as may otherwise be required by law.

§ 9.6.5 Contractor payments to material and equipment suppliers shall be treated in a manner similar to that provided in Sections 9.6.2, 9.6.3 and 9.6.4.

§ 9.6.6 A Certificate for Payment, a progress payment, or partial or entire use or occupancy of the Project by the Owner shall not constitute acceptance of Work not in accordance with the Contract Documents.

§ 9.6.7 Unless the Contractor provides the Owner with a payment bond in the full penal sum of the Contract Sum, payments received by the Contractor for Work properly performed by Subcontractors and suppliers shall be held by the Contractor for those Subcontractors or suppliers who performed Work or furnished materials, or both, under contract with the Contractor for which payment was made by the Owner. Nothing contained herein shall require money to be placed in a separate account and not commingled with money of the Contractor, shall create any fiduciary liability or tort liability on the part of the Contractor for breach of trust or shall entitle any person or entity to an award of punitive damages against the Contractor for breach of the requirements of this provision.

### § 9.7 FAILURE OF PAYMENT

If the Architect does not issue a Certificate for Payment, through no fault of the Contractor, within seven days after receipt of the Contractor's Application for Payment, or if the Owner does not pay the Contractor within seven days after the date established in the Contract Documents the amount certified by the Architect or awarded by binding dispute resolution, then the Contractor may, upon seven additional days' written notice to the Owner and Architect,



stop the Work until payment of the amount owing has been received. The Contract Time shall be extended appropriately and the Contract Sum shall be increased by the amount of the Contractor's reasonable costs of shut-down, delay and start-up, plus interest as provided for in the Contract Documents.

#### **§ 9.8 SUBSTANTIAL COMPLETION**

**§ 9.8.1** Substantial Completion is the stage in the progress of the Work when the Work or designated portion thereof is sufficiently complete in accordance with the Contract Documents so that the Owner can occupy or utilize the Work for its intended use.

**§ 9.8.2** When the Contractor considers that the Work, or a portion thereof which the Owner agrees to accept separately, is substantially complete, the Contractor shall prepare and submit to the Architect a comprehensive list of items to be completed or corrected prior to final payment. Failure to include an item on such list does not alter the responsibility of the Contractor to complete all Work in accordance with the Contract Documents.

**§ 9.8.3** Upon receipt of the Contractor's list, the Architect will make an inspection to determine whether the Work or designated portion thereof is substantially complete. If the Architect's inspection discloses any item, whether or not included on the Contractor's list, which is not sufficiently complete in accordance with the Contract Documents so that the Owner can occupy or utilize the Work or designated portion thereof for its intended use, the Contractor shall, before issuance of the Certificate of Substantial Completion, complete or correct such item upon notification by the Architect. In such case, the Contractor shall then submit a request for another inspection by the Architect to determine Substantial Completion.

**§ 9.8.4** When the Work or designated portion thereof is substantially complete, the Architect will prepare a Certificate of Substantial Completion that shall establish the date of Substantial Completion, shall establish responsibilities of the Owner and Contractor for security, maintenance, heat, utilities, damage to the Work and insurance, and shall fix the time within which the Contractor shall finish all items on the list accompanying the Certificate. Warranties required by the Contract Documents shall commence on the date of Substantial Completion of the Work or designated portion thereof unless otherwise provided in the Certificate of Substantial Completion.

**§ 9.8.5** The Certificate of Substantial Completion shall be submitted to the Owner and Contractor for their written acceptance of responsibilities assigned to them in such Certificate. Upon such acceptance and consent of surety, if any, the Owner shall make payment of retainage applying to such Work or designated portion thereof. Such payment shall be adjusted for Work that is incomplete or not in accordance with the requirements of the Contract Documents.

#### **§ 9.9 PARTIAL OCCUPANCY OR USE**

**§ 9.9.1** The Owner may occupy or use any completed or partially completed portion of the Work at any stage when such portion is designated by separate agreement with the Contractor, provided such occupancy or use is consented to by the insurer as required under Section 11.3.1.5 and authorized by public authorities having jurisdiction over the Project. Such partial occupancy or use may commence whether or not the portion is substantially complete, provided the Owner and Contractor have accepted in writing the responsibilities assigned to each of them for payments, retainage, if any, security, maintenance, heat, utilities, damage to the Work and insurance, and have agreed in writing concerning the period for correction of the Work and commencement of warranties required by the Contract Documents. When the Contractor considers a portion substantially complete, the Contractor shall prepare and submit a list to the Architect as provided under Section 9.8.2. Consent of the Contractor to partial occupancy or use shall not be unreasonably withheld. The stage of the progress of the Work shall be determined by written agreement between the Owner and Contractor or, if no agreement is reached, by decision of the Architect.

**§ 9.9.2** Immediately prior to such partial occupancy or use, the Owner, Contractor and Architect shall jointly inspect the area to be occupied or portion of the Work to be used in order to determine and record the condition of the Work.

**§ 9.9.3** Unless otherwise agreed upon, partial occupancy or use of a portion or portions of the Work shall not constitute acceptance of Work not complying with the requirements of the Contract Documents.

#### **§ 9.10 FINAL COMPLETION AND FINAL PAYMENT**

**§ 9.10.1** Upon receipt of the Contractor's written notice that the Work is ready for final inspection and acceptance and upon receipt of a final Application for Payment, the Architect will promptly make such inspection and, when the



Architect finds the Work acceptable under the Contract Documents and the Contract fully performed, the Architect will promptly issue a final Certificate for Payment stating that to the best of the Architect's knowledge, information and belief, and on the basis of the Architect's on-site visits and inspections, the Work has been completed in accordance with terms and conditions of the Contract Documents and that the entire balance found to be due the Contractor and noted in the final Certificate is due and payable. The Architect's final Certificate for Payment will constitute a further representation that conditions listed in Section 9.10.2 as precedent to the Contractor's being entitled to final payment have been fulfilled.

**§ 9.10.2** Neither final payment nor any remaining retained percentage shall become due until the Contractor submits to the Architect (1) an affidavit that payrolls, bills for materials and equipment, and other indebtedness connected with the Work for which the Owner or the Owner's property might be responsible or encumbered (less amounts withheld by Owner) have been paid or otherwise satisfied, (2) a certificate evidencing that insurance required by the Contract Documents to remain in force after final payment is currently in effect and will not be canceled or allowed to expire until at least 30 days' prior written notice has been given to the Owner, (3) a written statement that the Contractor knows of no substantial reason that the insurance will not be renewable to cover the period required by the Contract Documents, (4) consent of surety, if any, to final payment and (5), if required by the Owner, other data establishing payment or satisfaction of obligations, such as receipts, releases and waivers of liens, claims, security interests or encumbrances arising out of the Contract, to the extent and in such form as may be designated by the Owner. If a Subcontractor refuses to furnish a release or waiver required by the Owner, the Contractor may furnish a bond satisfactory to the Owner to indemnify the Owner against such lien. If such lien remains unsatisfied after payments are made, the Contractor shall refund to the Owner all money that the Owner may be compelled to pay in discharging such lien, including all costs and reasonable attorneys' fees.

**§ 9.10.3** If, after Substantial Completion of the Work, final completion thereof is materially delayed through no fault of the Contractor or by issuance of Change Orders affecting final completion, and the Architect so confirms, the Owner shall, upon application by the Contractor and certification by the Architect, and without terminating the Contract, make payment of the balance due for that portion of the Work fully completed and accepted. If the remaining balance for Work not fully completed or corrected is less than retainage stipulated in the Contract Documents, and if bonds have been furnished, the written consent of surety to payment of the balance due for that portion of the Work fully completed and accepted shall be submitted by the Contractor to the Architect prior to certification of such payment. Such payment shall be made under terms and conditions governing final payment, except that it shall not constitute a waiver of claims.

**§ 9.10.4** The making of final payment shall constitute a waiver of Claims by the Owner except those arising from

- .1 liens, Claims, security interests or encumbrances arising out of the Contract and unsettled;
- .2 failure of the Work to comply with the requirements of the Contract Documents; or
- .3 terms of special warranties required by the Contract Documents.

**§ 9.10.5** Acceptance of final payment by the Contractor, a Subcontractor or material supplier shall constitute a waiver of claims by that payee except those previously made in writing and identified by that payee as unsettled at the time of final Application for Payment.

## **ARTICLE 10 PROTECTION OF PERSONS AND PROPERTY**

### **§ 10.1 SAFETY PRECAUTIONS AND PROGRAMS**

The Contractor shall be responsible for initiating, maintaining and supervising all safety precautions and programs in connection with the performance of the Contract.

### **§ 10.2 SAFETY OF PERSONS AND PROPERTY**

**§ 10.2.1** The Contractor shall take reasonable precautions for safety of, and shall provide reasonable protection to prevent damage, injury or loss to

- .1 employees on the Work and other persons who may be affected thereby;
- .2 the Work and materials and equipment to be incorporated therein, whether in storage on or off the site, under care, custody or control of the Contractor or the Contractor's Subcontractors or Sub-subcontractors; and
- .3 other property at the site or adjacent thereto, such as trees, shrubs, lawns, walks, pavements, roadways, structures and utilities not designated for removal, relocation or replacement in the course of construction.



§ 10.2.2 The Contractor shall comply with and give notices required by applicable laws, statutes, ordinances, codes, rules and regulations, and lawful orders of public authorities bearing on safety of persons or property or their protection from damage, injury or loss.

§ 10.2.3 The Contractor shall erect and maintain, as required by existing conditions and performance of the Contract, reasonable safeguards for safety and protection, including posting danger signs and other warnings against hazards, promulgating safety regulations and notifying owners and users of adjacent sites and utilities.

§ 10.2.4 When use or storage of explosives or other hazardous materials or equipment or unusual methods are necessary for execution of the Work, the Contractor shall exercise utmost care and carry on such activities under supervision of properly qualified personnel.

§ 10.2.5 The Contractor shall promptly remedy damage and loss (other than damage or loss insured under property insurance required by the Contract Documents) to property referred to in Sections 10.2.1.2 and 10.2.1.3 caused in whole or in part by the Contractor, a Subcontractor, a Sub-subcontractor, or anyone directly or indirectly employed by any of them, or by anyone for whose acts they may be liable and for which the Contractor is responsible under Sections 10.2.1.2 and 10.2.1.3, except damage or loss attributable to acts or omissions of the Owner or Architect or anyone directly or indirectly employed by either of them, or by anyone for whose acts either of them may be liable, and not attributable to the fault or negligence of the Contractor. The foregoing obligations of the Contractor are in addition to the Contractor's obligations under Section 3.18.

§ 10.2.6 The Contractor shall designate a responsible member of the Contractor's organization at the site whose duty shall be the prevention of accidents. This person shall be the Contractor's superintendent unless otherwise designated by the Contractor in writing to the Owner and Architect.

§ 10.2.7 The Contractor shall not permit any part of the construction or site to be loaded so as to cause damage or create an unsafe condition.

#### § 10.2.8 INJURY OR DAMAGE TO PERSON OR PROPERTY

If either party suffers injury or damage to person or property because of an act or omission of the other party, or of others for whose acts such party is legally responsible, written notice of such injury or damage, whether or not insured, shall be given to the other party within a reasonable time not exceeding 21 days after discovery. The notice shall provide sufficient detail to enable the other party to investigate the matter.

#### § 10.3 HAZARDOUS MATERIALS

§ 10.3.1 The Contractor is responsible for compliance with any requirements included in the Contract Documents regarding hazardous materials. If the Contractor encounters a hazardous material or substance not addressed in the Contract Documents and if reasonable precautions will be inadequate to prevent foreseeable bodily injury or death to persons resulting from a material or substance, including but not limited to asbestos or polychlorinated biphenyl (PCB), encountered on the site by the Contractor, the Contractor shall, upon recognizing the condition, immediately stop Work in the affected area and report the condition to the Owner and Architect in writing.

§ 10.3.2 Upon receipt of the Contractor's written notice, the Owner shall obtain the services of a licensed laboratory to verify the presence or absence of the material or substance reported by the Contractor and, in the event such material or substance is found to be present, to cause it to be rendered harmless. Unless otherwise required by the Contract Documents, the Owner shall furnish in writing to the Contractor and Architect the names and qualifications of persons or entities who are to perform tests verifying the presence or absence of such material or substance or who are to perform the task of removal or safe containment of such material or substance. The Contractor and the Architect will promptly reply to the Owner in writing stating whether or not either has reasonable objection to the persons or entities proposed by the Owner. If either the Contractor or Architect has an objection to a person or entity proposed by the Owner, the Owner shall propose another to whom the Contractor and the Architect have no reasonable objection. When the material or substance has been rendered harmless, Work in the affected area shall resume upon written agreement of the Owner and Contractor. By Change Order, the Contract Time shall be extended appropriately and the Contract Sum shall be increased in the amount of the Contractor's reasonable additional costs of shut-down, delay and start-up.



§ 10.3.3 To the fullest extent permitted by law, the Owner shall indemnify and hold harmless the Contractor, Subcontractors, Architect, Architect's consultants and agents and employees of any of them from and against claims, damages, losses and expenses, including but not limited to attorneys' fees, arising out of or resulting from performance of the Work in the affected area if in fact the material or substance presents the risk of bodily injury or death as described in Section 10.3.1 and has not been rendered harmless, provided that such claim, damage, loss or expense is attributable to bodily injury, sickness, disease or death, or to injury to or destruction of tangible property (other than the Work itself), except to the extent that such damage, loss or expense is due to the fault or negligence of the party seeking indemnity.

§ 10.3.4 The Owner shall not be responsible under this Section 10.3 for materials or substances the Contractor brings to the site unless such materials or substances are required by the Contract Documents. The Owner shall be responsible for materials or substances required by the Contract Documents, except to the extent of the Contractor's fault or negligence in the use and handling of such materials or substances.

§ 10.3.5 The Contractor shall indemnify the Owner for the cost and expense the Owner incurs (1) for remediation of a material or substance the Contractor brings to the site and negligently handles, or (2) where the Contractor fails to perform its obligations under Section 10.3.1, except to the extent that the cost and expense are due to the Owner's fault or negligence.

§ 10.3.6 If, without negligence on the part of the Contractor, the Contractor is held liable by a government agency for the cost of remediation of a hazardous material or substance solely by reason of performing Work as required by the Contract Documents, the Owner shall indemnify the Contractor for all cost and expense thereby incurred.

#### § 10.4 EMERGENCIES

In an emergency affecting safety of persons or property, the Contractor shall act, at the Contractor's discretion, to prevent threatened damage, injury or loss. Additional compensation or extension of time claimed by the Contractor on account of an emergency shall be determined as provided in Article 15 and Article 7.

### ARTICLE 11 INSURANCE AND BONDS

#### § 11.1 CONTRACTOR'S LIABILITY INSURANCE

§ 11.1.1 The Contractor shall purchase from and maintain in a company or companies lawfully authorized to do business in the jurisdiction in which the Project is located such insurance as will protect the Contractor from claims set forth below which may arise out of or result from the Contractor's operations and completed operations under the Contract and for which the Contractor may be legally liable, whether such operations be by the Contractor or by a Subcontractor or by anyone directly or indirectly employed by any of them, or by anyone for whose acts any of them may be liable:

- .1 Claims under workers' compensation, disability benefit and other similar employee benefit acts that are applicable to the Work to be performed;
- .2 Claims for damages because of bodily injury, occupational sickness or disease, or death of the Contractor's employees;
- .3 Claims for damages because of bodily injury, sickness or disease, or death of any person other than the Contractor's employees;
- .4 Claims for damages insured by usual personal injury liability coverage;
- .5 Claims for damages, other than to the Work itself, because of injury to or destruction of tangible property, including loss of use resulting therefrom;
- .6 Claims for damages because of bodily injury, death of a person or property damage arising out of ownership, maintenance or use of a motor vehicle;
- .7 Claims for bodily injury or property damage arising out of completed operations; and
- .8 Claims involving contractual liability insurance applicable to the Contractor's obligations under Section 3.18.

§ 11.1.2 The insurance required by Section 11.1.1 shall be written for not less than limits of liability specified in the Contract Documents or required by law, whichever coverage is greater. Coverages, whether written on an occurrence or claims-made basis, shall be maintained without interruption from the date of commencement of the Work until the date of final payment and termination of any coverage required to be maintained after final payment, and, with respect to the Contractor's completed operations coverage, until the expiration of the period for correction



of Work or for such other period for maintenance of completed operations coverage as specified in the Contract Documents.

§ 11.1.3 Certificates of insurance acceptable to the Owner shall be filed with the Owner prior to commencement of the Work and thereafter upon renewal or replacement of each required policy of insurance. These certificates and the insurance policies required by this Section 11.1 shall contain a provision that coverages afforded under the policies will not be canceled or allowed to expire until at least 30 days' prior written notice has been given to the Owner. An additional certificate evidencing continuation of liability coverage, including coverage for completed operations, shall be submitted with the final Application for Payment as required by Section 9.10.2 and thereafter upon renewal or replacement of such coverage until the expiration of the time required by Section 11.1.2. Information concerning reduction of coverage on account of revised limits or claims paid under the General Aggregate, or both, shall be furnished by the Contractor with reasonable promptness.

§ 11.1.4 The Contractor shall cause the commercial liability coverage required by the Contract Documents to include (1) the Owner, the Architect and the Architect's consultants as additional insureds for claims caused in whole or in part by the Contractor's negligent acts or omissions during the Contractor's operations; and (2) the Owner as an additional insured for claims caused in whole or in part by the Contractor's negligent acts or omissions during the Contractor's completed operations.

#### § 11.2 OWNER'S LIABILITY INSURANCE

The Owner shall be responsible for purchasing and maintaining the Owner's usual liability insurance.

#### § 11.3 PROPERTY INSURANCE

§ 11.3.1 Unless otherwise provided, the Owner shall purchase and maintain, in a company or companies lawfully authorized to do business in the jurisdiction in which the Project is located, property insurance written on a builder's risk "all-risk" or equivalent policy form in the amount of the initial Contract Sum, plus value of subsequent Contract Modifications and cost of materials supplied or installed by others, comprising total value for the entire Project at the site on a replacement cost basis without optional deductibles. Such property insurance shall be maintained, unless otherwise provided in the Contract Documents or otherwise agreed in writing by all persons and entities who are beneficiaries of such insurance, until final payment has been made as provided in Section 9.10 or until no person or entity other than the Owner has an insurable interest in the property required by this Section 11.3 to be covered, whichever is later. This insurance shall include interests of the Owner, the Contractor, Subcontractors and Sub-subcontractors in the Project.

§ 11.3.1.1 Property insurance shall be on an "all-risk" or equivalent policy form and shall include, without limitation, insurance against the perils of fire (with extended coverage) and physical loss or damage including, without duplication of coverage, theft, vandalism, malicious mischief, collapse, earthquake, flood, windstorm, falsework, testing and startup, temporary buildings and debris removal including demolition occasioned by enforcement of any applicable legal requirements, and shall cover reasonable compensation for Architect's and Contractor's services and expenses required as a result of such insured loss.

§ 11.3.1.2 If the Owner does not intend to purchase such property insurance required by the Contract and with all of the coverages in the amount described above, the Owner shall so inform the Contractor in writing prior to commencement of the Work. The Contractor may then effect insurance that will protect the interests of the Contractor, Subcontractors and Sub-subcontractors in the Work, and by appropriate Change Order the cost thereof shall be charged to the Owner. If the Contractor is damaged by the failure or neglect of the Owner to purchase or maintain insurance as described above, without so notifying the Contractor in writing, then the Owner shall bear all reasonable costs properly attributable thereto.

§ 11.3.1.3 If the property insurance requires deductibles, the Owner shall pay costs not covered because of such deductibles.

§ 11.3.1.4 This property insurance shall cover portions of the Work stored off the site, and also portions of the Work in transit.

§ 11.3.1.5 Partial occupancy or use in accordance with Section 9.9 shall not commence until the insurance company or companies providing property insurance have consented to such partial occupancy or use by endorsement or



otherwise. The Owner and the Contractor shall take reasonable steps to obtain consent of the insurance company or companies and shall, without mutual written consent, take no action with respect to partial occupancy or use that would cause cancellation, lapse or reduction of insurance.

#### **§ 11.3.2 BOILER AND MACHINERY INSURANCE**

The Owner shall purchase and maintain boiler and machinery insurance required by the Contract Documents or by law, which shall specifically cover such insured objects during installation and until final acceptance by the Owner; this insurance shall include interests of the Owner, Contractor, Subcontractors and Sub-subcontractors in the Work, and the Owner and Contractor shall be named insureds.

#### **§ 11.3.3 LOSS OF USE INSURANCE**

The Owner, at the Owner's option, may purchase and maintain such insurance as will insure the Owner against loss of use of the Owner's property due to fire or other hazards, however caused. The Owner waives all rights of action against the Contractor for loss of use of the Owner's property, including consequential losses due to fire or other hazards however caused.

**§ 11.3.4** If the Contractor requests in writing that insurance for risks other than those described herein or other special causes of loss be included in the property insurance policy, the Owner shall, if possible, include such insurance, and the cost thereof shall be charged to the Contractor by appropriate Change Order.

**§ 11.3.5** If during the Project construction period the Owner insures properties, real or personal or both, at or adjacent to the site by property insurance under policies separate from those insuring the Project, or if after final payment property insurance is to be provided on the completed Project through a policy or policies other than those insuring the Project during the construction period, the Owner shall waive all rights in accordance with the terms of Section 11.3.7 for damages caused by fire or other causes of loss covered by this separate property insurance. All separate policies shall provide this waiver of subrogation by endorsement or otherwise.

**§ 11.3.6** Before an exposure to loss may occur, the Owner shall file with the Contractor a copy of each policy that includes insurance coverages required by this Section 11.3. Each policy shall contain all generally applicable conditions, definitions, exclusions and endorsements related to this Project. Each policy shall contain a provision that the policy will not be canceled or allowed to expire, and that its limits will not be reduced, until at least 30 days' prior written notice has been given to the Contractor.

#### **§ 11.3.7 WAIVERS OF SUBROGATION**

The Owner and Contractor waive all rights against (1) each other and any of their subcontractors, sub-subcontractors, agents and employees, each of the other, and (2) the Architect, Architect's consultants, separate contractors described in Article 6, if any, and any of their subcontractors, sub-subcontractors, agents and employees, for damages caused by fire or other causes of loss to the extent covered by property insurance obtained pursuant to this Section 11.3 or other property insurance applicable to the Work, except such rights as they have to proceeds of such insurance held by the Owner as fiduciary. The Owner or Contractor, as appropriate, shall require of the Architect, Architect's consultants, separate contractors described in Article 6, if any, and the subcontractors, sub-subcontractors, agents and employees of any of them, by appropriate agreements, written where legally required for validity, similar waivers each in favor of other parties enumerated herein. The policies shall provide such waivers of subrogation by endorsement or otherwise. A waiver of subrogation shall be effective as to a person or entity even though that person or entity would otherwise have a duty of indemnification, contractual or otherwise, did not pay the insurance premium directly or indirectly, and whether or not the person or entity had an insurable interest in the property damaged.

**§ 11.3.8** A loss insured under the Owner's property insurance shall be adjusted by the Owner as fiduciary and made payable to the Owner as fiduciary for the insureds, as their interests may appear, subject to requirements of any applicable mortgagee clause and of Section 11.3.10. The Contractor shall pay Subcontractors their just shares of insurance proceeds received by the Contractor, and by appropriate agreements, written where legally required for validity, shall require Subcontractors to make payments to their Sub-subcontractors in similar manner.

**§ 11.3.9** If required in writing by a party in interest, the Owner as fiduciary shall, upon occurrence of an insured loss, give bond for proper performance of the Owner's duties. The cost of required bonds shall be charged against proceeds received as fiduciary. The Owner shall deposit in a separate account proceeds so received, which the



Owner shall distribute in accordance with such agreement as the parties in interest may reach, or as determined in accordance with the method of binding dispute resolution selected in the Agreement between the Owner and Contractor. If after such loss no other special agreement is made and unless the Owner terminates the Contract for convenience, replacement of damaged property shall be performed by the Contractor after notification of a Change in the Work in accordance with Article 7.

§ 11.3.10 The Owner as fiduciary shall have power to adjust and settle a loss with insurers unless one of the parties in interest shall object in writing within five days after occurrence of loss to the Owner's exercise of this power; if such objection is made, the dispute shall be resolved in the manner selected by the Owner and Contractor as the method of binding dispute resolution in the Agreement. If the Owner and Contractor have selected arbitration as the method of binding dispute resolution, the Owner as fiduciary shall make settlement with insurers or, in the case of a dispute over distribution of insurance proceeds, in accordance with the directions of the arbitrators.

#### § 11.4 PERFORMANCE BOND AND PAYMENT BOND

§ 11.4.1 The Owner shall have the right to require the Contractor to furnish bonds covering faithful performance of the Contract and payment of obligations arising thereunder as stipulated in bidding requirements or specifically required in the Contract Documents on the date of execution of the Contract.

§ 11.4.2 Upon the request of any person or entity appearing to be a potential beneficiary of bonds covering payment of obligations arising under the Contract, the Contractor shall promptly furnish a copy of the bonds or shall authorize a copy to be furnished.

### ARTICLE 12 UNCOVERING AND CORRECTION OF WORK

#### § 12.1 UNCOVERING OF WORK

§ 12.1.1 If a portion of the Work is covered contrary to the Architect's request or to requirements specifically expressed in the Contract Documents, it must, if requested in writing by the Architect, be uncovered for the Architect's examination and be replaced at the Contractor's expense without change in the Contract Time.

§ 12.1.2 If a portion of the Work has been covered that the Architect has not specifically requested to examine prior to its being covered, the Architect may request to see such Work and it shall be uncovered by the Contractor. If such Work is in accordance with the Contract Documents, costs of uncovering and replacement shall, by appropriate Change Order, be at the Owner's expense. If such Work is not in accordance with the Contract Documents, such costs and the cost of correction shall be at the Contractor's expense unless the condition was caused by the Owner or a separate contractor in which event the Owner shall be responsible for payment of such costs.

#### § 12.2 CORRECTION OF WORK

##### § 12.2.1 BEFORE OR AFTER SUBSTANTIAL COMPLETION

The Contractor shall promptly correct Work rejected by the Architect or failing to conform to the requirements of the Contract Documents, whether discovered before or after Substantial Completion and whether or not fabricated, installed or completed. Costs of correcting such rejected Work, including additional testing and inspections, the cost of uncovering and replacement, and compensation for the Architect's services and expenses made necessary thereby, shall be at the Contractor's expense.

##### § 12.2.2 AFTER SUBSTANTIAL COMPLETION

§ 12.2.2.1 In addition to the Contractor's obligations under Section 3.5, if, within one year after the date of Substantial Completion of the Work or designated portion thereof or after the date for commencement of warranties established under Section 9.9.1, or by terms of an applicable special warranty required by the Contract Documents, any of the Work is found to be not in accordance with the requirements of the Contract Documents, the Contractor shall correct it promptly after receipt of written notice from the Owner to do so unless the Owner has previously given the Contractor a written acceptance of such condition. The Owner shall give such notice promptly after discovery of the condition. During the one-year period for correction of Work, if the Owner fails to notify the Contractor and give the Contractor an opportunity to make the correction, the Owner waives the rights to require correction by the Contractor and to make a claim for breach of warranty. If the Contractor fails to correct nonconforming Work within a reasonable time during that period after receipt of notice from the Owner or Architect, the Owner may correct it in accordance with Section 2.4.



§ 12.2.2.2 The one-year period for correction of Work shall be extended with respect to portions of Work first performed after Substantial Completion by the period of time between Substantial Completion and the actual completion of that portion of the Work.

§ 12.2.2.3 The one-year period for correction of Work shall not be extended by corrective Work performed by the Contractor pursuant to this Section 12.2.

§ 12.2.3 The Contractor shall remove from the site portions of the Work that are not in accordance with the requirements of the Contract Documents and are neither corrected by the Contractor nor accepted by the Owner.

§ 12.2.4 The Contractor shall bear the cost of correcting destroyed or damaged construction, whether completed or partially completed, of the Owner or separate contractors caused by the Contractor's correction or removal of Work that is not in accordance with the requirements of the Contract Documents.

§ 12.2.5 Nothing contained in this Section 12.2 shall be construed to establish a period of limitation with respect to other obligations the Contractor has under the Contract Documents. Establishment of the one-year period for correction of Work as described in Section 12.2.2 relates only to the specific obligation of the Contractor to correct the Work, and has no relationship to the time within which the obligation to comply with the Contract Documents may be sought to be enforced, nor to the time within which proceedings may be commenced to establish the Contractor's liability with respect to the Contractor's obligations other than specifically to correct the Work.

### § 12.3 ACCEPTANCE OF NONCONFORMING WORK

If the Owner prefers to accept Work that is not in accordance with the requirements of the Contract Documents, the Owner may do so instead of requiring its removal and correction, in which case the Contract Sum will be reduced as appropriate and equitable. Such adjustment shall be effected whether or not final payment has been made.

## ARTICLE 13 MISCELLANEOUS PROVISIONS

### § 13.1 GOVERNING LAW

The Contract shall be governed by the law of the place where the Project is located except that, if the parties have selected arbitration as the method of binding dispute resolution, the Federal Arbitration Act shall govern Section 15.4.

### § 13.2 SUCCESSORS AND ASSIGNS

§ 13.2.1 The Owner and Contractor respectively bind themselves, their partners, successors, assigns and legal representatives to covenants, agreements and obligations contained in the Contract Documents. Except as provided in Section 13.2.2, neither party to the Contract shall assign the Contract as a whole without written consent of the other. If either party attempts to make such an assignment without such consent, that party shall nevertheless remain legally responsible for all obligations under the Contract.

§ 13.2.2 The Owner may, without consent of the Contractor, assign the Contract to a lender providing construction financing for the Project, if the lender assumes the Owner's rights and obligations under the Contract Documents. The Contractor shall execute all consents reasonably required to facilitate such assignment.

### § 13.3 WRITTEN NOTICE

Written notice shall be deemed to have been duly served if delivered in person to the individual, to a member of the firm or entity, or to an officer of the corporation for which it was intended; or if delivered at, or sent by registered or certified mail or by courier service providing proof of delivery to, the last business address known to the party giving notice.

### § 13.4 RIGHTS AND REMEDIES

§ 13.4.1 Duties and obligations imposed by the Contract Documents and rights and remedies available thereunder shall be in addition to and not a limitation of duties, obligations, rights and remedies otherwise imposed or available by law.

§ 13.4.2 No action or failure to act by the Owner, Architect or Contractor shall constitute a waiver of a right or duty afforded them under the Contract, nor shall such action or failure to act constitute approval of or acquiescence in a breach there under, except as may be specifically agreed in writing.



## § 13.5 TESTS AND INSPECTIONS

§ 13.5.1 Tests, inspections and approvals of portions of the Work shall be made as required by the Contract Documents and by applicable laws, statutes, ordinances, codes, rules and regulations or lawful orders of public authorities. Unless otherwise provided, the Contractor shall make arrangements for such tests, inspections and approvals with an independent testing laboratory or entity acceptable to the Owner, or with the appropriate public authority, and shall bear all related costs of tests, inspections and approvals. The Contractor shall give the Architect timely notice of when and where tests and inspections are to be made so that the Architect may be present for such procedures. The Owner shall bear costs of (1) tests, inspections or approvals that do not become requirements until after bids are received or negotiations concluded, and (2) tests, inspections or approvals where building codes or applicable laws or regulations prohibit the Owner from delegating their cost to the Contractor.

§ 13.5.2 If the Architect, Owner or public authorities having jurisdiction determine that portions of the Work require additional testing, inspection or approval not included under Section 13.5.1, the Architect will, upon written authorization from the Owner, instruct the Contractor to make arrangements for such additional testing, inspection or approval by an entity acceptable to the Owner, and the Contractor shall give timely notice to the Architect of when and where tests and inspections are to be made so that the Architect may be present for such procedures. Such costs, except as provided in Section 13.5.3, shall be at the Owner's expense.

§ 13.5.3 If such procedures for testing, inspection or approval under Sections 13.5.1 and 13.5.2 reveal failure of the portions of the Work to comply with requirements established by the Contract Documents, all costs made necessary by such failure including those of repeated procedures and compensation for the Architect's services and expenses shall be at the Contractor's expense.

§ 13.5.4 Required certificates of testing, inspection or approval shall, unless otherwise required by the Contract Documents, be secured by the Contractor and promptly delivered to the Architect.

§ 13.5.5 If the Architect is to observe tests, inspections or approvals required by the Contract Documents, the Architect will do so promptly and, where practicable, at the normal place of testing.

§ 13.5.6 Tests or inspections conducted pursuant to the Contract Documents shall be made promptly to avoid unreasonable delay in the Work.

## § 13.6 INTEREST

Payments due and unpaid under the Contract Documents shall bear interest from the date payment is due at such rate as the parties may agree upon in writing or, in the absence thereof, at the legal rate prevailing from time to time at the place where the Project is located.

## § 13.7 TIME LIMITS ON CLAIMS

The Owner and Contractor shall commence all claims and causes of action, whether in contract, tort, breach of warranty or otherwise, against the other arising out of or related to the Contract in accordance with the requirements of the final dispute resolution method selected in the Agreement within the time period specified by applicable law, but in any case not more than 10 years after the date of Substantial Completion of the Work. The Owner and Contractor waive all claims and causes of action not commenced in accordance with this Section 13.7.

## ARTICLE 14 TERMINATION OR SUSPENSION OF THE CONTRACT

### § 14.1 TERMINATION BY THE CONTRACTOR

§ 14.1.1 The Contractor may terminate the Contract if the Work is stopped for a period of 30 consecutive days through no act or fault of the Contractor or a Subcontractor, Sub-subcontractor or their agents or employees or any other persons or entities performing portions of the Work under direct or indirect contract with the Contractor, for any of the following reasons:

- .1 Issuance of an order of a court or other public authority having jurisdiction that requires all Work to be stopped;
- .2 An act of government, such as a declaration of national emergency that requires all Work to be stopped;



- .3 Because the Architect has not issued a Certificate for Payment and has not notified the Contractor of the reason for withholding certification as provided in Section 9.4.1, or because the Owner has not made payment on a Certificate for Payment within the time stated in the Contract Documents; or
- .4 The Owner has failed to furnish to the Contractor promptly, upon the Contractor's request, reasonable evidence as required by Section 2.2.1.

§ 14.1.2 The Contractor may terminate the Contract if, through no act or fault of the Contractor or a Subcontractor, Sub-subcontractor or their agents or employees or any other persons or entities performing portions of the Work under direct or indirect contract with the Contractor, repeated suspensions, delays or interruptions of the entire Work by the Owner as described in Section 14.3 constitute in the aggregate more than 100 percent of the total number of days scheduled for completion, or 120 days in any 365-day period, whichever is less.

§ 14.1.3 If one of the reasons described in Section 14.1.1 or 14.1.2 exists, the Contractor may, upon seven days' written notice to the Owner and Architect, terminate the Contract and recover from the Owner payment for Work executed, including reasonable overhead and profit, costs incurred by reason of such termination, and damages.

§ 14.1.4 If the Work is stopped for a period of 60 consecutive days through no act or fault of the Contractor or a Subcontractor or their agents or employees or any other persons performing portions of the Work under contract with the Contractor because the Owner has repeatedly failed to fulfill the Owner's obligations under the Contract Documents with respect to matters important to the progress of the Work, the Contractor may, upon seven additional days' written notice to the Owner and the Architect, terminate the Contract and recover from the Owner as provided in Section 14.1.3.

#### § 14.2 TERMINATION BY THE OWNER FOR CAUSE

§ 14.2.1 The Owner may terminate the Contract if the Contractor

- .1 repeatedly refuses or fails to supply enough properly skilled workers or proper materials;
- .2 fails to make payment to Subcontractors for materials or labor in accordance with the respective agreements between the Contractor and the Subcontractors;
- .3 repeatedly disregards applicable laws, statutes, ordinances, codes, rules and regulations, or lawful orders of a public authority; or
- .4 otherwise is guilty of substantial breach of a provision of the Contract Documents.

§ 14.2.2 When any of the above reasons exist, the Owner, upon certification by the Initial Decision Maker that sufficient cause exists to justify such action, may without prejudice to any other rights or remedies of the Owner and after giving the Contractor and the Contractor's surety, if any, seven days' written notice, terminate employment of the Contractor and may, subject to any prior rights of the surety:

- .1 Exclude the Contractor from the site and take possession of all materials, equipment, tools, and construction equipment and machinery thereon owned by the Contractor;
- .2 Accept assignment of subcontracts pursuant to Section 5.4; and
- .3 Finish the Work by whatever reasonable method the Owner may deem expedient. Upon written request of the Contractor, the Owner shall furnish to the Contractor a detailed accounting of the costs incurred by the Owner in finishing the Work.

§ 14.2.3 When the Owner terminates the Contract for one of the reasons stated in Section 14.2.1, the Contractor shall not be entitled to receive further payment until the Work is finished.

§ 14.2.4 If the unpaid balance of the Contract Sum exceeds costs of finishing the Work, including compensation for the Architect's services and expenses made necessary thereby, and other damages incurred by the Owner and not expressly waived, such excess shall be paid to the Contractor. If such costs and damages exceed the unpaid balance, the Contractor shall pay the difference to the Owner. The amount to be paid to the Contractor or Owner, as the case may be, shall be certified by the Initial Decision Maker, upon application, and this obligation for payment shall survive termination of the Contract.

#### § 14.3 SUSPENSION BY THE OWNER FOR CONVENIENCE

§ 14.3.1 The Owner may, without cause, order the Contractor in writing to suspend, delay or interrupt the Work in whole or in part for such period of time as the Owner may determine.



§ 14.3.2 The Contract Sum and Contract Time shall be adjusted for increases in the cost and time caused by suspension, delay or interruption as described in Section 14.3.1. Adjustment of the Contract Sum shall include profit. No adjustment shall be made to the extent

- .1 that performance is, was or would have been so suspended, delayed or interrupted by another cause for which the Contractor is responsible; or
- .2 that an equitable adjustment is made or denied under another provision of the Contract.

#### § 14.4 TERMINATION BY THE OWNER FOR CONVENIENCE

§ 14.4.1 The Owner may, at any time, terminate the Contract for the Owner's convenience and without cause.

§ 14.4.2 Upon receipt of written notice from the Owner of such termination for the Owner's convenience, the Contractor shall

- .1 cease operations as directed by the Owner in the notice;
- .2 take actions necessary, or that the Owner may direct, for the protection and preservation of the Work; and
- .3 except for Work directed to be performed prior to the effective date of termination stated in the notice, terminate all existing subcontracts and purchase orders and enter into no further subcontracts and purchase orders.

§ 14.4.3 In case of such termination for the Owner's convenience, the Contractor shall be entitled to receive payment for Work executed, and costs incurred by reason of such termination, along with reasonable overhead and profit on the Work not executed.

### ARTICLE 15 CLAIMS AND DISPUTES

#### § 15.1 CLAIMS

##### § 15.1.1 DEFINITION

A Claim is a demand or assertion by one of the parties seeking, as a matter of right, payment of money, or other relief with respect to the terms of the Contract. The term "Claim" also includes other disputes and matters in question between the Owner and Contractor arising out of or relating to the Contract. The responsibility to substantiate Claims shall rest with the party making the Claim.

##### § 15.1.2 NOTICE OF CLAIMS

Claims by either the Owner or Contractor must be initiated by written notice to the other party and to the Initial Decision Maker with a copy sent to the Architect, if the Architect is not serving as the Initial Decision Maker. Claims by either party must be initiated within 21 days after occurrence of the event giving rise to such Claim or within 21 days after the claimant first recognizes the condition giving rise to the Claim, whichever is later.

##### § 15.1.3 CONTINUING CONTRACT PERFORMANCE

Pending final resolution of a Claim, except as otherwise agreed in writing or as provided in Section 9.7 and Article 14, the Contractor shall proceed diligently with performance of the Contract and the Owner shall continue to make payments in accordance with the Contract Documents. The Architect will prepare Change Orders and issue Certificates for Payment in accordance with the decisions of the Initial Decision Maker.

##### § 15.1.4 CLAIMS FOR ADDITIONAL COST

If the Contractor wishes to make a Claim for an increase in the Contract Sum, written notice as provided herein shall be given before proceeding to execute the Work. Prior notice is not required for Claims relating to an emergency endangering life or property arising under Section 10.4.

##### § 15.1.5 CLAIMS FOR ADDITIONAL TIME

§ 15.1.5.1 If the Contractor wishes to make a Claim for an increase in the Contract Time, written notice as provided herein shall be given. The Contractor's Claim shall include an estimate of cost and of probable effect of delay on progress of the Work. In the case of a continuing delay, only one Claim is necessary.

§ 15.1.5.2 If adverse weather conditions are the basis for a Claim for additional time, such Claim shall be documented by data substantiating that weather conditions were abnormal for the period of time, could not have been reasonably anticipated and had an adverse effect on the scheduled construction.



### § 15.1.6 CLAIMS FOR CONSEQUENTIAL DAMAGES

The Contractor and Owner waive Claims against each other for consequential damages arising out of or relating to this Contract. This mutual waiver includes

- .1 damages incurred by the Owner for rental expenses, for losses of use, income, profit, financing, business and reputation, and for loss of management or employee productivity or of the services of such persons; and
- .2 damages incurred by the Contractor for principal office expenses including the compensation of personnel stationed there, for losses of financing, business and reputation, and for loss of profit except anticipated profit arising directly from the Work.

This mutual waiver is applicable, without limitation, to all consequential damages due to either party's termination in accordance with Article 14. Nothing contained in this Section 15.1.6 shall be deemed to preclude an award of liquidated damages, when applicable, in accordance with the requirements of the Contract Documents.

### § 15.2 INITIAL DECISION

§ 15.2.1 Claims, excluding those arising under Sections 10.3, 10.4, 11.3.9, and 11.3.10, shall be referred to the Initial Decision Maker for initial decision. The Architect will serve as the Initial Decision Maker, unless otherwise indicated in the Agreement. Except for those Claims excluded by this Section 15.2.1, an initial decision shall be required as a condition precedent to mediation of any Claim arising prior to the date final payment is due, unless 30 days have passed after the Claim has been referred to the Initial Decision Maker with no decision having been rendered. Unless the Initial Decision Maker and all affected parties agree, the Initial Decision Maker will not decide disputes between the Contractor and persons or entities other than the Owner.

§ 15.2.2 The Initial Decision Maker will review Claims and within ten days of the receipt of a Claim take one or more of the following actions: (1) request additional supporting data from the claimant or a response with supporting data from the other party, (2) reject the Claim in whole or in part, (3) approve the Claim, (4) suggest a compromise, or (5) advise the parties that the Initial Decision Maker is unable to resolve the Claim if the Initial Decision Maker lacks sufficient information to evaluate the merits of the Claim or if the Initial Decision Maker concludes that, in the Initial Decision Maker's sole discretion, it would be inappropriate for the Initial Decision Maker to resolve the Claim.

§ 15.2.3 In evaluating Claims, the Initial Decision Maker may, but shall not be obligated to, consult with or seek information from either party or from persons with special knowledge or expertise who may assist the Initial Decision Maker in rendering a decision. The Initial Decision Maker may request the Owner to authorize retention of such persons at the Owner's expense.

§ 15.2.4 If the Initial Decision Maker requests a party to provide a response to a Claim or to furnish additional supporting data, such party shall respond, within ten days after receipt of such request, and shall either (1) provide a response on the requested supporting data, (2) advise the Initial Decision Maker when the response or supporting data will be furnished or (3) advise the Initial Decision Maker that no supporting data will be furnished. Upon receipt of the response or supporting data, if any, the Initial Decision Maker will either reject or approve the Claim in whole or in part.

§ 15.2.5 The Initial Decision Maker will render an initial decision approving or rejecting the Claim, or indicating that the Initial Decision Maker is unable to resolve the Claim. This initial decision shall (1) be in writing; (2) state the reasons therefor; and (3) notify the parties and the Architect, if the Architect is not serving as the Initial Decision Maker, of any change in the Contract Sum or Contract Time or both. The initial decision shall be final and binding on the parties but subject to mediation and, if the parties fail to resolve their dispute through mediation, to binding dispute resolution.

§ 15.2.6 Either party may file for mediation of an initial decision at any time, subject to the terms of Section 15.2.6.1.

§ 15.2.6.1 Either party may, within 30 days from the date of an initial decision, demand in writing that the other party file for mediation within 60 days of the initial decision. If such a demand is made and the party receiving the demand fails to file for mediation within the time required, then both parties waive their rights to mediate or pursue binding dispute resolution proceedings with respect to the initial decision.



§ 15.2.7 In the event of a Claim against the Contractor, the Owner may, but is not obligated to, notify the surety, if any, of the nature and amount of the Claim. If the Claim relates to a possibility of a Contractor's default, the Owner may, but is not obligated to, notify the surety and request the surety's assistance in resolving the controversy.

§ 15.2.8 If a Claim relates to or is the subject of a mechanic's lien, the party asserting such Claim may proceed in accordance with applicable law to comply with the lien notice or filing deadlines.

### § 15.3 MEDIATION

§ 15.3.1 Claims, disputes, or other matters in controversy arising out of or related to the Contract except those waived as provided for in Sections 9.10.4, 9.10.5, and 15.1.6 shall be subject to mediation as a condition precedent to binding dispute resolution.

§ 15.3.2 The parties shall endeavor to resolve their Claims by mediation which, unless the parties mutually agree otherwise, shall be administered by the American Arbitration Association in accordance with its Construction Industry Mediation Procedures in effect on the date of the Agreement. A request for mediation shall be made in writing, delivered to the other party to the Contract, and filed with the person or entity administering the mediation. The request may be made concurrently with the filing of binding dispute resolution proceedings but, in such event, mediation shall proceed in advance of binding dispute resolution proceedings, which shall be stayed pending mediation for a period of 60 days from the date of filing, unless stayed for a longer period by agreement of the parties or court order. If an arbitration is stayed pursuant to this Section 15.3.2, the parties may nonetheless proceed to the selection of the arbitrator(s) and agree upon a schedule for later proceedings.

§ 15.3.3 The parties shall share the mediator's fee and any filing fees equally. The mediation shall be held in the place where the Project is located, unless another location is mutually agreed upon. Agreements reached in mediation shall be enforceable as settlement agreements in any court having jurisdiction thereof.

### § 15.4 ARBITRATION

§ 15.4.1 If the parties have selected arbitration as the method for binding dispute resolution in the Agreement, any Claim subject to, but not resolved by, mediation shall be subject to arbitration which, unless the parties mutually agree otherwise, shall be administered by the American Arbitration Association in accordance with its Construction Industry Arbitration Rules in effect on the date of the Agreement. A demand for arbitration shall be made in writing, delivered to the other party to the Contract, and filed with the person or entity administering the arbitration. The party filing a notice of demand for arbitration must assert in the demand all Claims then known to that party on which arbitration is permitted to be demanded.

§ 15.4.1.1 A demand for arbitration shall be made no earlier than concurrently with the filing of a request for mediation, but in no event shall it be made after the date when the institution of legal or equitable proceedings based on the Claim would be barred by the applicable statute of limitations. For statute of limitations purposes, receipt of a written demand for arbitration by the person or entity administering the arbitration shall constitute the institution of legal or equitable proceedings based on the Claim.

§ 15.4.2 The award rendered by the arbitrator or arbitrators shall be final, and judgment may be entered upon it in accordance with applicable law in any court having jurisdiction thereof.

§ 15.4.3 The foregoing agreement to arbitrate and other agreements to arbitrate with an additional person or entity duly consented to by parties to the Agreement shall be specifically enforceable under applicable law in any court having jurisdiction thereof.

### § 15.4.4 CONSOLIDATION OR JOINDER

§ 15.4.4.1 Either party, at its sole discretion, may consolidate an arbitration conducted under this Agreement with any other arbitration to which it is a party provided that (1) the arbitration agreement governing the other arbitration permits consolidation, (2) the arbitrations to be consolidated substantially involve common questions of law or fact, and (3) the arbitrations employ materially similar procedural rules and methods for selecting arbitrator(s).

§ 15.4.4.2 Either party, at its sole discretion, may include by joinder persons or entities substantially involved in a common question of law or fact whose presence is required if complete relief is to be accorded in arbitration, provided that the party sought to be joined consents in writing to such joinder. Consent to arbitration involving an

additional person or entity shall not constitute consent to arbitration of any claim, dispute or other matter in question not described in the written consent.

§ 15.4.4.3 The Owner and Contractor grant to any person or entity made a party to an arbitration conducted under this Section 15.4, whether by joinder or consolidation, the same rights of joinder and consolidation as the Owner and Contractor under this Agreement.





**DOCUMENT 00 73 00**  
**SUPPLEMENTARY CONDITIONS**  
**FOR GENERAL CONDITIONS FOR THE CONTRACT FOR CONSTRUCTION**

**PART 1 GENERAL**

The following supplements modify, change, delete from or add to AIA Document A201, General Conditions of the Contract for Construction 2007 Edition. Where any part of the AIA General Conditions is amended, voided, or superseded by the Supplementary Conditions, the unaltered provisions shall remain in effect.

**1.1 ARTICLE 1 GENERAL PROVISIONS**

**A. BASIC DEFINITIONS**

1. Add the following Subparagraphs:

1.1.9 ARCHITECT/ENGINEER/CONSULTANT

Where the term ARCHITECT is used in the bidding documents, Contract documents, Addenda, Change Orders or other documents related to this contract, it shall be defined as either "Architect" or "Engineer" or "Consultant" depending upon which design professional has prepared the document in question or which professional is performing the designated task.

1.1.10 MISCELLANEOUS DEFINITIONS

.1 "Provide:" Furnish and install, or furnish labor and materials required for installation, ready for use and in accordance with the Contract Documents.

.2 "As shown:" As indicated, as detailed, as noted, or words of similar import refer to Contract Documents.

.3 "Selected:" As selected by the Architect.

.4 "Approved:" Approved by Architect.

.5 "For Approval:" For the Architect's approval.

**B. CORRELATION AND INTENT OF THE CONTRACT DOCUMENTS**

1. Add the following to Subparagraph 1.2.1:

1.2.1.1 In the event of conflicts or discrepancies among the Contract Documents, interpretations will be based on the following priorities.

1. The Agreement.
2. Addenda, with those of later date having precedence over those of earlier date.
3. The Supplementary Conditions.
4. The General Conditions of the Contract for Construction.
5. Division 1 of the Specifications.
6. Drawings and Divisions 2- 49 of the Specifications.

In the case of conflicts or discrepancies between Drawings and Divisions 2- 49 of the Specifications or within either Document not clarified by Addendum, the Architect will determine which takes precedence in accordance with Subparagraph 4.2.11.

2. Add the following Subparagraphs:

1.2.4 If work is required in such a manner to make it impossible to produce first class work or should discrepancies appear among Contract Documents, request interpretation before proceeding with work. If Contractor fails to make such request, the Contractor will thereafter be expected to carry out work in satisfactory manner.

**SUPPLEMENTARY CONDITIONS - DOCUMENT 00 73 00**

1.2.5 Reference to codes, standard specifications, or other standards means and intends latest edition of such documents and/or adopted as of bid date. Where brand name products are specified and no installation instructions given herein, install product in accordance with the manufacturer's specifications and instructions, latest edition.

1.2.6 No provision of any reference standard specification, manual or code shall change the privileges or responsibilities of Owner, Architect, or Contractor, or any of their consultants, agents or employees from those set forth in the Contract Documents, nor shall it be effective to assign to Architect, or any of Architect's consultants, agents or employees, any duty or authority to supervise or direct the furnishing or performance of the work or any duty or authority to undertake responsibility contrary to the provision of the Contract Documents.

1.2.7 Sections of Division 1, General Requirements govern the execution of all sections of the specifications.

**1.2 ARTICLE 2 OWNER**

**A. 2.1 GENERAL**

1. Add the following Subparagraph:

2.1.3 The Owner is the Eugene School District 4J, 200 North Monroe Street, Eugene, Oregon 97402, (541) 790-7417.

The Owner's representative is Douglas Lemonds, 541-790-7432, 715 West Fourth Avenue, Eugene, OR 97402.

**B. INFORMATION AND SERVICES REQUIRED OF THE OWNER**

1. Delete Subparagraph 2.2.5 and substitute the following:

2.2.5 The Contractor will be furnished free of charge up to 5 copies of the Contract Documents. The Owner will furnish additional copies requested by the Contractor at the cost of reproduction, postage and handling.

**1.3 ARTICLE 3 CONTRACTOR**

**A. 3.1 GENERAL**

1. Delete the second sentence to Subparagraph 3.1.1, and add the following:

The Contractor and each subcontractor shall maintain for the duration of the Project a registration with the Oregon State Construction Contractor's Board.

2. Add the following Subparagraph 3.1.4

3.1.4 The Contractor is required to demonstrate that an employee drug testing program is in place.

3. Add the following Subparagraph 3.1.5

3.1.5 The Contractor certifies that the Contractor is not presently debarred, suspended, proposed for debarment, declared ineligible, or voluntarily excluded from participating in this Contract by any Federal department or agency. If requested by the Eugene 4J School District, the Contractor shall complete a Certification Regarding Debarment, Suspension, Ineligibility, and Voluntary Exclusion form. Any such form completed by the Contractor for this Contract shall be incorporated into this Contract by reference.

**B. 3.2 REVIEW OF CONTRACT DOCUMENTS AND FIELD CONDITIONS BY CONTRACTOR**

1. Delete the last sentence to Subparagraph 3.2.4, and add the following:

If the Contractor performs those obligations, the Contractor shall not be liable to the Owner or Architect for damages resulting from errors, inconsistencies or omissions in the Contract Documents, for differences between field measurements or conditions and the Contract Documents, unless the Contractor recognized such error, inconsistency, omission or difference and knowingly failed to report it to the Architect.



C. 3.3 SUPERVISION AND CONSTRUCTION PROCEDURES

1. Add the following Subparagraphs:

3.3.4 The Contractor shall review with all Subcontractors, construction means, methods and materials to be used to verify their compliance with all safety standards and laws and be responsible for compliance with same to insure safe, hazard free conditions for all persons visiting or working on the entire project.

3.3.5 The Contractor shall comply with the provisions of Oregon Revised Statutes and 4J Board Policy. Attention is directed to ORS 279A and 279C, Public Contracting Code.

D. 3.4 LABOR AND MATERIALS

1. Add the following Subparagraphs:

3.4.4 PAYMENT OF LABORERS AND MATERIALMEN, CONTRIBUTIONS TO INDUSTRIAL ACCIDENT FUND, LIENS AND WITHHOLDING TAXES: The Contractor shall: (1) Make payment promptly, as due, to all persons supplying to such contractor labor or material for the prosecution of the Work provided for in such contract. (2) Pay all contributions or amounts due the Industrial Accident Fund from such Contractor or subcontractor incurred in the performance of the contract. (3) Not permit any lien or claim to be filed or prosecuted against the state, county, school district, municipality, municipal corporation or subdivision thereof, on account of any labor or material furnished. (4) Pay to the Department of Revenue all sums withheld from employees pursuant to ORS 316.167.

3.4.5 HOURS OF LABOR: No person shall be employed for more than ten hours in any one day, or 40 hours in any one week, except in the cases of necessity, emergency, or where the public policy absolutely requires it, and in such cases the person so employed shall be paid at least time and a half of the regular pay for all time worked.

.1 For all overtime in excess of eight hours a day or 40 hours in any one week when the work week is five consecutive days, Monday through Friday; or

.2 For all overtime in excess of 10 hours a day or 40 hours in any one week when the work week is four consecutive days, Monday through Friday; and

.3 For all work performed on Saturday and on any legal holiday specified in ORS 279C.540.

.4 Worker claims for overtime, in order to be considered, must be filed with the Contractor within 90 days from the completion of the contract, in accordance with ORS 279C.545.

The Contractor shall give notice to employees who work on a public contract in writing, either at the time of hire or before commencement of work on the contract, or by posting a notice in a location frequented by employees, of the number of hours per day and days per week the employees may be required to work.

3.4.6 PAYMENT FOR MEDICAL CARE AND PROVIDING WORKERS' COMPENSATION: The Contractor shall promptly, as due, make payment to any person, co-partnership, association or corporation, furnishing medical, surgical and hospital care or other needed care and attention, incident to sickness or injury, to the employees of such Contractor, of all sums which the Contractor agrees to pay for such services and all moneys and sums which the Contractor collected or deducted from the wages of employees pursuant to any law, contract or agreement for the purpose of providing or paying for such service. All employers working under this contract are subject employers and must comply with ORS 656.017.

3.4.7 PREVAILING WAGE RATES: When the total price of the Project is \$50,000 or more, each worker in each trade or occupation employed in the performance of this Contract either by the contractor, subcontractor or other person doing or contracting to do contracting for the whole or any part of the Work on the Contract shall be paid not less than the applicable state prevailing rate of wage. This provision applies to all contracts, regardless of the price of the individual contract, as long as the combined price of all contracts awarded on the Project is \$50,000 or more.

a. The existing Oregon prevailing rate of wage in effect at the time the specifications are first advertised for bid solicitations is the applicable rate.

- b. The Owner will pay the public works fee to Oregon Bureau of Labor and Industries.
- c. Certification of rate or wage by Contractor or Subcontractor (ORS 279C.845):
  - .1 The contractor or the contractor's surety and every subcontractor or the subcontractor's surety shall file certified statements with the public agency in writing, on a form prescribed by the Commissioner of the Bureau of Labor and Industries, certifying the hourly rate of wage paid each worker whom the contractor or the subcontractor has employed upon the public works, and further certifying that no worker employed upon the public works has been paid less than the higher of the applicable state or federal prevailing rate of wage or less than the minimum hourly rate of wage specified in the contract. The certificate and statement shall be verified by the oath of the contractor or the contractor's surety or subcontractor or the subcontractor's surety that the contractor or subcontractor has read the statement and certificate and knows the contents thereof and that the same is true to the contractor or subcontractor's knowledge. The certified statements shall set out accurately and completely the payroll records for the prior week, including the name and address of each worker, the worker's correct classification, rate of pay, daily and weekly number of hours worked, deductions made, and actual wages paid.
  - .2 If the Contractor does not file certified payroll as required (at least once per month) the Owner will withhold 25% of the amounts due the Contractor, in addition to any other required retainage.
  - .3 If a first-tier Subcontractor does not file certified payroll reports as required, the prime Contractor shall withhold 25% of amounts due the first-tier Subcontractor.
  - .4 Each certified statement required by subsection (1) of this section shall be delivered or mailed by the contractor or subcontractor to the public contracting agency. Certified statements shall be submitted to the public contracting agency once a month by the fifth business day of the following month, for each week workers are employed. Information submitted on certified statements may be used only to ensure compliance with the provisions of ORS 279C.800 to 279C.870.
  - .5 Each contractor or subcontractor shall preserve the certified statements for a period of three years from the date of completion of the contract.
  - .6 Certified statements received by a public agency are public records subject to the provisions of ORS 192.410 to 192.505. As such, they must be made available upon request.

3.4.8 PAYMENT OF CLAIMS BY PUBLIC OFFICERS: If the Contractor fails, neglects or refuses to make prompt payment of any claims for labor or services furnished to the Contractor or a subcontractor by any person in connection with this Contract as such claim becomes due, the Owner may pay such claim and charge the amount of the payment against funds due or to become due the Contractor by reason of this Contract.

3.4.9 PAYMENT FOR MEDICAL CARE AND PROVIDING WORKERS' COMPENSATION: The Contractor shall promptly, as due, make payment to any person, co-partnership, association or corporation, furnishing medical, surgical and hospital care or other needed care and attention, incident to sickness or injury, to the employees of such Contractor, of all sums which the Contractor agrees to pay for such services and all moneys and sums which the Contractor collected or deducted from the wages of employees pursuant to any law, contract or agreement for the purpose of providing or paying for such service.

3.4.10 Any person owed for labor or material by a subcontractor or Contractor may file a complaint with the Construction Contractors Board in accordance with ORS 279C.515(3).

**E. 3.7 PERMITS, FEES AND NOTICES**

- 1. Delete Subparagraph 3.7.1, and substitute the following:

3.7.1 The OWNER will pay the plan check fee, building permit fee, and systems development charges directly to the authority having jurisdiction. The Owner will pay the initial review and approval costs for deferred submittals, which are specifically required by the governing jurisdiction during the plan review process, directly to the authority having jurisdiction. Any deferred submittal costs due to incomplete



submittals, or corrections required by the governing jurisdiction shall be the responsibility of the contractor.

The CONTRACTOR shall pay for all other permits, fees, licenses and inspections necessary for the proper execution and completion of the Work which are customarily secured after execution of the Contract and which are legally required when bids are received or negotiations concluded. The Contractor shall pick up permits and call for inspections through final inspection, as required by the City Building Department.

**F. 3.12 SHOP DRAWINGS, PRODUCT DATA AND SAMPLES**

1. Add the following to Subparagraph 3.12.5:

Submittals which are not marked as reviewed for compliance with the Contract Documents and approved by the Contractor may be returned by the Architect without action.

2. Add the following to Subparagraph 3.12.9:

Shop drawings that are submitted to the Architect for review do not constitute "in writing" unless it is brought to the attention of the Architect, in written form, that specific changes are being suggested. In any event, changes to the contract documents by means of shop drawings become the responsibility of the person initiating such changes.

**G. 3.18 INDEMNIFICATION**

1. Delete Subparagraph 3.18.1, and substitute the following:

13.18.1 To the fullest extent of the law, the Contractor will defend, indemnify, hold harmless and reimburse the Eugene School District 4J (including its officers, board members, agents, and employees) from all claims, demands, suits, actions, penalties, and damage expenses, for liability of any kind including attorney's fees. To the extent that death or bodily injury to persons or damage to property arises out of the fault of the Contractor, the Contractor's indemnity obligation exists only to the extent that the death or bodily injury to persons or damage to property arises out of the fault of the Contractor, or the fault of the Contractor's agents, representatives or subcontractors, contributed to or caused such damage, whether or not such incidents are contributed to or caused in any part by Eugene School District 4J.

**1.4 ARTICLE 4 ARCHITECT**

**A. 4.1 GENERAL**

1. Modify Paragraph 4.1.1

- a. In the first sentence delete "shall retain" and insert "may have retained" in it's place.
- b. Add sentence: "The term "Architect" means the Architect or the Architect's authorized representative."

2. Add the following to Subparagraph 4.1.2:

Written consent of the Contractor shall only apply to those items which directly or indirectly affect the work of the Contractor.

3. Add the following Subparagraph:

In the first sentence delete "shall" and insert "may" in its place.

4. Add the following Subparagraph:

4.1.4 The Environmental Consultant is defined as:

PBS Engineering + Environmental  
2645 Willamette Street, Eugene, Oregon  
541-686-8684

**B. 4.2 ADMINISTRATION OF THE CONTRACT**

1. Add the following sentence to 4.2.1:

**SUPPLEMENTARY CONDITIONS - DOCUMENT 00 73 00**

The architect may be retained to administer the Contract through the specified period for correction of the Work described in Section 12.2

2. Add the following to Subparagraph 4.2.4:

4.2.4.1 The Owner may communicate directly with the Contractor when necessary or appropriate. The Owner may give direction to the Contractor in matters related to access to the site, coordination with Owner's occupancy and use by the public, use of parking and staging areas, use of potentially hazardous products, drug and alcohol policy, no smoking policy, appropriate dress and behavior, safety requirements and safe work practices, where appropriate. The Owner will advise the Architect regarding any communication with or direction given to the Contractor.

4.2.4.2 Representatives of the Owner, Contractor and Architect shall meet periodically at mutually agreed-upon intervals for the purpose of establishing procedures to facilitate cooperation, communication and timely responses among the participants. By participating in this arrangement, the parties do not intend to create additional contractual obligations or modify the legal relationships which may otherwise exist. Nothing in this agreement shall give the Architect the authority to make decisions or give direction without the Owner's concurrence.

3. Add the following to Subparagraph 4.2.9:

4.2.9.1 The Architect will make one inspection for the determination of Substantial Completion and one for determination of Final Acceptance. Such inspections will be made only after receipt of written notification of readiness for such inspections from Contractor.

4.2.9.2 Should additional inspections beyond those listed in 4.2.9.1 be required due to Contractor's failure to satisfactorily complete all work, the Contractor shall become responsible for all costs incurred by the Owner in conjunction with required re-inspections. A deductive Change Order shall be prepared using the following hourly rates as the basis for calculating the amounts to be deducted:

Environmental Consultant:	\$100 per hour
District 4J Personnel:	\$75 per hour

4.2.9.3 The amount to be deducted from the Contract shall be calculated by multiplying the hours expended in additional inspections and documentation by the hourly rates listed in 4.2.9.2.

4. Add the following sentence to Subparagraph 4.2.11:

The architect's response will be within 10 days of receipt of written requests from the Owner or Contractor.

5. Delete Subparagraph 4.2.13, and substitute the following:

4.2.13 Decisions on matters related to aesthetic effect will be made collaboratively between the Owner and the Architect. The final decision shall be the Owner's, if consistent with the intent expressed in the Contract Documents.

6. Add the following sentence to Subparagraph 4.2.14

The architect's response will be within 10 days of receipt of written requests from the Owner or Contractor.

**1.5 ARTICLE 5 SUBCONTRACTORS**

**A. 5.3 SUBCONTRACTUAL RELATIONS**

1. Add the following Subparagraphs:

5.3.1 The Contractor shall include in each subcontract for property or services entered into by the Contractor and a subcontractor, including a material supplier, for the purpose of performing a construction contract:

- .1 A payment clause that obligates the Contractor to pay the subcontractor for satisfactory performance under its subcontract within 10 days out of such amounts as are paid to the Contractor by the owner under such contract; and
- .2 An interest penalty clause that obligates the Contractor to pay to the subcontractor an interest



**SUPPLEMENTARY CONDITIONS - DOCUMENT 00 73 00**

penalty on amounts due in the case of each payment not made in accordance with the payment clause included in the subcontract pursuant to paragraph .1 of this section for the period beginning on the day after the required payment date and ending on the date on which payment of the amount due is made; computed at the rate specified in ORS 279C.580.

5.3.2 The Contractor shall include in each of its subcontracts, for the purpose of performance of such contract condition, a provision requiring the subcontractor to include a payment clause and an interest penalty clause conforming to the requirements of Subparagraph 5.3.1 in each of its subcontracts and to require each of its subcontractors to include such clauses in their subcontracts with each lower-tier subcontractor or supplier.

**1.6 ARTICLE 6 CONSTRUCTION BY OWNER OR BY SEPARATE CONTRACTORS**

No modifications.

**1.7 ARTICLE 7 CHANGES IN THE WORK**

**A. 7.1 GENERAL**

1. Paragraph 7.1.2, delete the following: “an order for minor changes in the Work can be issued by the Architect alone”.

2. Add the following Subparagraph 7.1.4 to Paragraph 7.1:

7.1.4 The combined overhead and profit included in the total cost or credit to the Owner of a change in the Work shall not exceed that stated in 7.1.4.4 below. In no case shall the Contractor’s or Subcontractors individual overhead and profit request exceed the following schedule:

.1 For the Contractor, for Work performed by the Contractor’s own forces, 15 percent of the cost.

.2 For the Contractor, for Work performed by the Contractor’s Subcontractors, 10 percent of the amount due the Subcontractors.

.3 For each Subcontractor involved, for Work performed by that Subcontractor’s own forces, 10 percent of the cost.

.4 The **Base Cost** to which overhead and profit is to be applied shall be determined in accordance with Subparagraph 7.3.7., articles .1, .2, .3, .4, and .5. To this **Base Cost** is added the applicable overhead and profit. In no case shall the combined overhead and profit (including all Contractor and Subcontractor(s) overhead and profit) exceed 25 percent of this **Base Cost**.

.5 In order to facilitate checking of quotations for extras or credits, all proposals, except those so minor that their propriety can be seen by inspection, shall be accompanied by a complete itemization of costs including those applicable costs from paragraph 7.3.7, .1 - .5, and Subcontractor and Contractor overhead and profit as applicable.

.6 Cost of preparing change order shall not be included in cost of Change Order.

3. Add the following Subparagraph 7.1.5 to Paragraph 7.1:

7.1.5 A Change Order providing a net CREDIT to the Owner shall include a credit for overhead and profit based on the following schedule:

.1 For the Contractor, 5 percent of the Cost to be credited.

.2 For each Subcontractor, 5 percent of the Cost to be credited.

.3 For each Sub-subcontractor, 5 percent of the Cost to be credited.

.4 All other provisions of Subparagraph 7.1.4 shall apply to Credit Change Orders.

**B. 7.3 CONSTRUCTION CHANGE DIRECTIVES**

1. Add the following to Subparagraph 7.3.1:

For the purposes of this Agreement, The Owner’s “CHANGE REQUEST/PROCEED ORDER” may be substituted for and used interchangeably with “CONSTRUCTION CHANGE DIRECTIVE”.

2. Modify Subparagraph 7.3.7 as follows:

In the first sentence, delete the words "a reasonable amount." and substitute "an amount for overhead and profit in accordance with Paragraph 7.1.4 or 7.1.5."

3. Delete Subparagraph 7.3.7.1 and substitute the following:

7.3.7.1 The maximum allowable hourly wage rate for Changes to the Work shall be the appropriate Base Wage Rate plus Fringe Rate as listed for each occupation in the Prevailing Wage Rate for Public Works Contracts in Oregon manual issued by the Oregon Bureau of Industries; multiplied by 1.25. An amount for Overhead and Profit may be added in accordance with Paragraph 7.1.4 or 7.1.5.

4. Delete 7.3.7.3, and substitute the following:

7.3.7.3 Rental costs of machinery and equipment, exclusive of hand tools and motor vehicles, when rented from the Contractor or others;

5. Change the first sentence of Subparagraph 7.3.8 to read as follows:

The amount of credit to be allowed by the Contractor to the Owner for a deletion or change that results in a net decrease in the Contract Sum shall be actual net cost, including overhead and profit according to the schedule in Subparagraph 7.1.5 above.

6. Change the first sentence of Subparagraph 7.3.9 to read as follows:

Pending final determination of the total cost of a Construction Change Directive to the Owner, the Contractor may request payment for Work completed under the Construction Change Directive in the Application for Payment accompanied by an executed Change Order indicating the parties' agreement with part or all of such costs.

1.8 ARTICLE 8 TIME

A. 8.2 PROGRESS AND COMPLETION

1. Add the following Subparagraph 8.2.4

8.2.4 The Contractor agrees that said work shall be executed regularly, diligently, at such a rate of progress as will insure Substantial Completion thereof within the time specified. It is expressly understood and agreed by and between the Contractor and the Owner that the time for the completion of the work described herein is reasonable taking into consideration the average climatic range and usual industrial conditions prevailing in this locality.

1.9 ARTICLE 9 PAYMENT AND COMPLETION

A. 9.2 SCHEDULE OF VALUES

1. Revise the first sentence of Subparagraph 9.2 to read as follows:

".... the Contractor shall submit to the Architect and the Owner,....."

2. Add the following sentence to Paragraph 9.2:

Submit on AIA Document A703, latest edition.

B. 9.3 APPLICATIONS FOR PAYMENT

1. Add the following sentence to Subparagraph 9.3.1:

The form of Application for Payment shall be a notarized AIA Document G702, Application and Certification for Payment, supported by AIA Document G703, Continuation Sheet.

2. Delete Clause 9.3.1.1, and substitute the following:

9.3.1.1 As provided in Section 7.3.9, such applications may include requests for payment on account of changes in the Work that have been properly authorized by Construction Change Directives, accompanied by an executed Change Order.

C. 9.5 DECISIONS TO WITHHOLD CERTIFICATION

1. Delete Subparagraph 9.5.3.



D. 9.6 PROGRESS PAYMENTS

1. Add the following Clause to Subparagraph 9.6.1:

9.6.1.1 After the Architect has issued a certificate for payment and it has been approved by the Owner, the Owner will pay the Contractor 95 percent (95%) of the total value of material and labor incorporated into the project as indicated on the Application for Payment less the aggregate of previous payments. Progress schedule update shall accompany each payment request.

9.6.1.2 Payment will be made within fifteen (15) days of approval of the Application for Payment by School District 4J ("Progress Payment Due Date").

9.6.1.3 The first Application for Payment and each subsequent Application for Payment will not be considered complete unless it is accompanied by the certified payroll for the contractor and all subcontractors requesting payment.

2. Add the following Subparagraph to Paragraph 9.6:

9.6.8 In lieu of cash retainage to be held by the Owner, the Contractor may select one of the following options:

- .1 The Contractor may deposit bonds or securities with the Owner or in any bank or trust company to be held for the benefit of the Owner. In such event, the Owner shall reduce the retainage in an equal amount to the value of the bonds and securities.
- .2 Upon written request of the Contractor, the Owner will deposit any amounts withheld as retainage in an interest-bearing account in a bank, savings bank, trust company or savings association for the benefit of the Owner. Interest earned shall accrue to the Contractor.
- .3 If the Owner incurs additional costs as a result of the exercise of any of the options for retainage described herein, the Owner may recover such costs from the Contractor by reduction of final payment.

E. 9.8 SUBSTANTIAL COMPLETION

1. Delete Subparagraph 9.8.1 and substitute the following:

9.8.1 Substantial Completion is the stage in the progress of the Work when the Work or designated portion thereof is sufficiently complete in accordance with the Contract Documents so the Owner can fully occupy and fully utilize the Work for its intended use with only minor corrective work remaining which can be accomplished without disruption of the occupants.

2. Delete the last two sentences to Subparagraph 9.8.5 and add the following:

9.8.5 Upon Substantial Completion of the Work, the Contractor may submit an application for payment in accordance with Subparagraph 9.3.1 in an amount sufficient to increase the total payments to ninety-five percent (95%) of the Contract Sum, less such amounts as the Architect determines for incomplete Work or unsettled claims.

F. 9.10 FINAL COMPLETION AND FINAL PAYMENT

1. Modify Item (2) in Subparagraph 9.10.2 to read:

(2) A certificate evidencing that insurance required by the Contract Documents to remain in force after final payment is currently in effect, (3) a .....

2. Add the following Subparagraph to Paragraph 9.10:

9.10.6 The Contractor shall not permit any lien or claim to be filed or prosecuted against the Owner on account of any labor or material furnished in connection with the Work.

G. Add the following Paragraphs to Article 9:

1. 9.11 LIQUIDATED DAMAGES

9.11.1 The Owner will suffer financial loss if the Work is not Substantially Complete, as defined in Article 9.8.1 above, on the dates specified in Section 01 11 00. The Contractor and the Contractor's

**SUPPLEMENTARY CONDITIONS - DOCUMENT 00 73 00**

surety shall be liable for and shall pay the Owner the sum hereinafter stipulated as fixed, agreed, and liquidated damages for each calendar day of delay until the date established in the Certificate of Substantial Completion.

The agreed amount of liquidated damages is **1,000** per each calendar day. The amount of liquidated damages may be reduced in cases of partial occupancy, at the sole discretion of the Owner.

**2. 9.12 AGENCY PAYMENT FOR UNPAID LABOR OR SUPPLIES**

9.12.1 Contract incomplete. If the Contract is still in force, the Agency may, in accordance with ORS 279C.515, pay a valid claim to the Entity furnishing the labor or services, and charge the amount against payments due or to become due to the Contractor under the Contract. If an Agency chooses to make such a payment as provided in 279C.515, the Contractor and the Contractor's surety shall not be relieved from liability for unpaid claims.

9.12.2. Contract completed. If the Contract has been completed and all funds disbursed to the prime Contractor, all claims shall be referred to the Contractor's surety for resolution. The Agency shall not make payments to subcontractors or suppliers for Work already paid for by the Agency.

**1.10 ARTICLE 10 PROTECTION OF PERSONS AND PROPERTY**

**A. 10.1 SAFETY PRECAUTIONS AND PROGRAMS**

**1. Add the following sentence to Article 10.1**

Where asbestos abatement is part of the Work, the Contractor or appropriate subcontractor shall be licensed by the Department of Environmental Quality to perform "asbestos abatement work", OAR 340-248-0120, Adopted January 25, 1990, and meet requirements of AHERA, as specified in Federal Register 40CFR, Part 763.

**B. 10.3 HAZARDOUS MATERIALS**

**1. Delete Subparagraph 10.3.3.**

**1.11 ARTICLE 11 INSURANCE AND BONDS**

**A. 11.1 CONTRACTOR'S LIABILITY INSURANCE**

**1. Modify the second sentence of Subparagraph 11.1.2 as follows:**

a. Delete the following: "...and, with respect to the Contractor's completed operations coverage, until the expiration of the period for correction of Work or for such other period for maintenance of coverage as specified in the Contract Documents."

**2. Add the following Clause to Subparagraph 11.1.2:**

.1. The Contractor shall provide and maintain in force for the duration of this agreement, the following:

**.1 General Insurance:**

The Contractor shall maintain in force for the duration of this agreement a Umbrella Insurance Policy with the limits not less than \$5,000,000, a Commercial General Liability, Automobile Liability (owned, non-owned and hired) Insurance policy(s) written on an occurrence basis with limits not less than \$1,000,000 per occurrence and \$2,000,000 in the aggregated naming the District, its employees, officials and agents as an additional insured as respects to work or services performed under this agreement. This insurance will be primary to any insurance the District may carry on its own. If the District requires Professional Liability coverage, the terms, conditions, and limits must be approved by the District's Risk Manager. (eff. 4/2/13)

The commercial General Liability policy shall be written on a form that meets the following criteria, and must be ASBESTOS SPECIFIC, as follows:

- i. A full occurrence form, or
- ii. A limited occurrence form with at least three (3) years tail, or
- iii. A claims-made form with a three (3) year tail.



.2 Workers' Compensation:

Contractor shall provide and maintain workers' compensation coverage for its employees, officers, agents, or partners, as required by applicable workers' compensation laws.

.3 Evidence of Coverage:

Evidence of the above coverages issued by a company satisfactory to the District shall be provided to the District by way of a certificate of insurance before any work or services commence. A 30-day notice of cancellation or material change in coverage clause shall be included. It is the Contractor's obligation to provide the 30 days notice if not done so by the Contractor's insurance company(s). Failure to maintain the proper insurance shall be grounds for immediate termination of this Agreement.

.4 Subcontractors:

The Contractor shall require all subcontractors to provide and maintain general liability, auto liability, professional liability (as applicable) and Workers' Compensation insurance with coverage's equivalent to those required of the General Contractor in this Agreement. The Contractor shall require certificates of insurance from all subcontractors as evidence of coverage.

.5 Exceptions or Waivers:

Any exception or waiver of these requirements shall be subject to review and written approval from the Eugene School District Risk Manager.

3. Delete the second sentence of Subparagraph 11.1.3

4. Add the following sentences to Subparagraph 11.1.3:

The Contractor shall provide written notification to the Owner of the cancellation or expiration of any insurance required by Section 11.1. The Contractor shall provide such written notice within five (5) business days of the date the Contractor is first aware of the cancellation or expiration, or is first aware that the cancellation or expiration is threatened or otherwise may occur, whichever comes first.

**B. 11.3 PROPERTY INSURANCE**

1. Modify the first sentence of Subparagraph 11.3.1 as follows:

- a. Delete "Unless otherwise provided, the Owner" and substitute "The Contractor".
- b. Modify the last sentence by adding "Architect," after the word "Owner".

2. Add the following to Clause 11.3.1.1:

The form of policy for this coverage shall be Completed Value. If the Owner is damaged by the failure of the Contractor to maintain such insurance, then the Contractor shall bear all reasonable costs properly attributed thereto.

3. Delete Clause 11.3.1.2.

4. Modify Clause 11.3.1.3 by substituting "Contractor" for "Owner".

5. Delete Clause 11.3.1.4.

6. Modify the first sentence of Subparagraph 11.3.2 to read: "The Owner, at the Owner's option, may purchase..."

7. Delete Subparagraph 11.3.4.

8. Delete Subparagraph 11.3.6, and substitute the following:

11.3.6 Evidence of the above coverages issued by a company satisfactory to the District shall be provided to the District by way of a certificate of insurance before any work or services commence. The Contractor shall provide written notification to the Owner of the cancellation or expiration of any insurance required by Section 11.3. The Contractor shall provide such written notice within five (5) business days of the date the Contractor is first aware of the cancellation or expiration, or is first aware

**SUPPLEMENTARY CONDITIONS - DOCUMENT 00 73 00**

that the cancellation or expiration is threatened or otherwise may occur, whichever comes first. Failure to maintain the proper insurance shall be grounds for immediate termination of this Agreement.

9. Modify 11.3.7 by substituting “Contractor” for “Owner” at the end of the first sentence.
10. Modify the first sentence of Subparagraph 11.3.8 to read as follows:

11.3.8 A loss insured under the Contractor’s property insurance shall be adjusted by the Contractor as fiduciary and made payable to the Contractor and Owner, as their interests may appear, subject to requirements of any applicable mortgagee clause.
11. Delete Subparagraph 11.3.9.
12. Modify the first sentence of Subparagraph 11.3.10 by substituting “Contractor” for “Owner” the first two times it occurs. Modify the last sentence by substituting “Contractor” for “Owner” the second time it occurs.
13. Add the following Subparagraph:

11.3.11 EQUIPMENT AND MATERIAL:

The Contractor shall be responsible for any loss, damage, or destruction of Contractor’s own property, equipment, and materials used in conjunction with the Work.

**C. 11.4 PERFORMANCE BOND AND PAYMENT BOND**

1. Delete 11.4.1 and 11.4.2 and substitute the following:

11.4.1 Unless otherwise stated in the solicitation document, prior to execution of the Agreement, the Bidder shall furnish separate bonds that in all respects conform to the requirements of ORS 279C.380 covering the faithful performance of the Contract, and the payment of all obligations arising thereunder, each in an amount equal to one hundred percent (100%) of the Contract sum. The duration of the performance bond shall match the length of the project warranty.

11.4.2 The surety issuing such bonds shall be duly authorized and licensed to issue bonds in the State of Oregon. The bonds shall be executed by an Attorney-in-fact, principal or other authorized representative for the surety company, showing the Oregon agent for service, and bears the seal of the surety company. Where the bond is executed by a person outside the state of Oregon, his authority to execute bond shall be shown.

11.4.3 Bonds are to be obtained through a company that is on the US Government Treasury list for approved sureties and/or approved by the Owner’s Risk Manager.

11.4.4 Bonds shall be submitted on AIA Document A312, latest edition.

11.4.5 The cost of furnishing such bonds shall be included in the bid.

11.4.6 The Contractor shall deliver the required bonds to the Owner with the signed Agreement to:

Kathi Hernandez  
Facilities Management Office  
Eugene Public School District 4J  
715 West Fourth  
Eugene, Oregon 97402

11.4.7 The Contractor shall require the Attorney-in-fact who executes the required bonds on behalf of the surety to affix thereto a certified and current copy of their power of attorney.

**D. Add the following Paragraphs to Article 11:**

1. **11.5 PUBLIC WORKS BOND:**

11.5.1 Pursuant to ORS 279C.836, for any contract awarded where the contract price is \$100,000 or greater, the Contractor and every subcontractor shall have a Public Works bond, in the amount of \$30,000 filed with the Construction Contractors Board (CCB) before starting work on the project unless exempt. This bond is in addition to performance bond and payment bond requirements. **A copy of the Contractor’s State of Oregon Statutory Public Works Bond shall be provided with the executed**



**contract documents.**

11.5.2 Contractor shall include in every subcontract a provision requiring their Subcontractors to have a public works bond filed with the CCB before starting work on the project, unless exempt. Contractors shall verify that all of their subcontractors have filed a public works bond with the CCB.

1.12 ARTICLE 12 UNCOVERING AND CORRECTION OF WORK

A. 12.2 AFTER SUBSTANTIAL COMPLETION

1. Add the following sentence to Clause 12.2.2.1:

The correction period relating to faulty products and workmanship will begin on the date appearing on the Certificate of Substantial Completion, or if a Certificate of Substantial Completion is not issued, on the date appearing on the Final Certificate of Payment to the Contractor, whichever is earlier. The Owner's use of the project will not alter the warranty period herein defined.

2. Add the following sentence to Clause 12.2.2.2:

The correction periods specified are an extension of the one-year correction period called for in the General Conditions and are in addition to any guaranty bond called for elsewhere.

1.13 ARTICLE 13 MISCELLANEOUS PROVISIONS

A. 13.1 GOVERNING LAW

1. Change Paragraph 13.1 to read as follows:

13.1 The Contract shall be governed by the law of the place where the Project is located.

B. Add the following Subparagraph 13.1.1:

13.1.1 Contractor shall be in compliance with the Oregon Department of Revenue tax certification rules including OAR 150-305.385 (6)-A, (6)-B, (6)-C and (7).

C. Revise Subparagraph 13.2.1 as follows:

Delete last two sentences, and replace with:

Contractor shall not assign, sell, dispose of, or transfer rights, nor delegate duties under the contract, either in whole or in part, without the Contracting Agency's prior written consent. Unless otherwise agreed by the Contracting Agency in writing, such consent shall not relieve the Contractor of any obligations under the contract. Any assignee or transferee shall be considered the agent of the Contractor and be bound to abide by all provisions of the contract. If the Contracting Agency consents in writing to an assignment, sale, disposal or transfer of the Contractor's rights or delegation of Contractor's duties, the Contractor and its surety, if any, shall remain liable to the Contracting Agency for complete performance of the contract as if no such assignment, sale, disposal, transfer or delegation had occurred unless the Contracting Agency otherwise agrees in writing, in accordance with ORS 279A.065.

D. Delete Subparagraph 13.2.2

E. Add the following Paragraphs to Article 13:

1. 13.8 ENVIRONMENTAL AND NATURAL RESOURCES LAWS AND RULES

13.8.1 The Contractor and subcontractors shall comply with federal, state, and local ordinances and regulations dealing with prevention of pollution and preservation of natural resources that affect Work of this project.

13.8.2 Pursuant to ORS 279C.525, If the Contractor is delayed or must undertake additional work by reason of existing regulation or ordinances of agencies not cited in the Contract Documents or due to the enactment of new or the amendment of existing statutes, ordinances, or regulations relating to the prevention of environmental pollution and the preservation of natural resources occurring after the Bid Date, the Owner will grant a time extension and issue a change order setting forth the additional work that must be undertaken. The change order shall not invalidate the contract and there shall be, in addition to a reasonable extension of the Contract time, a reasonable adjustment in the Contract price to

**SUPPLEMENTARY CONDITIONS - DOCUMENT 00 73 00**

compensate the successful bidder for all costs and expenses incurred, including overhead and profits, as a result of such delay or additional work.

2. 13.9 FOREIGN CONTRACTORS

In the event this Contract is awarded to a Contractor not domiciled in or registered to do business in the State of Oregon and the contract price exceeds \$10,000, the Contractor shall promptly report to the Department of Revenue the total price, terms of payment, length of contract, and such other information as the Department of Revenue may require before final payment can be received on the public contract. The Owner will satisfy itself that the requirement of this subsection has been complied with before it issues a Final Payment.

3. 13.10 EQUAL OPPORTUNITY

13.10.1 The Contractor shall maintain policies of employment as follows:

13.10.1.1 The Contractor and the Contractor's subcontractors shall not discriminate against any employee or applicant for employment because of race, religion, color, sex or national origin. The Contractor shall take affirmative action to insure that applicants are employed, and that employees are treated during employment without regard to their race, religion, color, sex, national origin, physical or mental handicap, sexual orientation or age, unless based upon bona fide occupational qualifications; and that they are otherwise in compliance with all federal, state and local laws prohibiting discrimination. Such action shall include, but not be limited to, the following: employment, upgrading, demotion or transfer; recruitment or recruitment advertising; layoff or termination; rates of pay or other forms of compensation; and selection for training, including apprenticeship. It is further understood that any vendor who is in violation of this clause shall be barred forthwith from receiving awards of any purchase order from the School District, unless a satisfactory showing is made that discriminatory practices have terminated and that a recurrence of such acts is unlikely. The Contractor agrees to post in conspicuous places, available to employees and applicants for employment, notices setting forth the policies of nondiscrimination.

13.10.1.2 The Contractor and the Contractor's subcontractors shall, in all solicitations or advertisements for employees placed by them or on their behalf, state that all qualified applicants will receive consideration for employment without regard to race, religion, color, sex or national origin.

4. 13.11 DRUG-TESTING PROGRAM

13.11.1 The contractor agrees with the provisions of Oregon Revised Statutes 279C.505, which requires that the contractor shall demonstrate it has established a drug-testing program for employees and will require each subcontractor providing labor for the Project to do the same.

1.14 ARTICLE 14 TERMINATION OR SUSPENSION OF THE CONTRACT

No modifications.

1.15 ARTICLE 15 CLAIMS AND DISPUTES

A. 15 CLAIMS AND DISPUTES

1. Add the following to Clause 15.1.5.2

Abnormal weather conditions for the purposes of this agreement are defined as conditions more extreme than any conditions experienced within the general vicinity of the site for each project for a comparable period at any time within the past ten years.

2. Delete Subparagraph 15.1.6.

B. 15.2 INITIAL DECISION

1. Modify Subparagraph 15.2.1 as follows:

In the third sentence, change "30 days" to read "10 days" and add the following: The Initial Decision Maker shall review all submitted claims and render decisions as soon as possible.

2. Modify Clause 15.2.6.1 as follows:



**SUPPLEMENTARY CONDITIONS - DOCUMENT 00 73 00**

In the first sentence, change the “30 days and “60 days” to read “10 days” and “30 days” respectively.

**C. 15.3 MEDIATION**

1. Delete Paragraph 15.3 MEDIATION, and substitute the following:

**15.3 MEDIATION AND ARBITRATION**

15.3.1 Parties shall attempt to resolve all disputes at the lowest possible level. Both parties to this Agreement agree to provide other resources and personnel to negotiate and find resolution to disputes that cannot be resolved at the Project Manager level. As a next step, claims, disputes or other matters in question between the parties to this Agreement arising out of or relating to this Agreement or breach thereof shall be determined by mediation, arbitration or litigation. Disputes shall be initially submitted to mediation by a mediator chosen by the parties. The cost of mediation shall be borne equally by the parties. If the parties are unable to agree upon a mediator within five days or if mediation fails to resolve the dispute, either party may request that the dispute be submitted to arbitration before a single arbitrator agreed to by the parties in an additional five days. If both parties agree to arbitration but are unable to agree upon an arbitrator, each party shall select an arbitrator, the arbitrators so chosen shall select a third, and the decision of a majority of the arbitrators shall be final, binding the parties, and any judgment may be entered thereon. Unless the parties mutually agree otherwise, any arbitration proceeding shall be conducted in accordance with the currently in effect Construction Industry Arbitration Rules of the American Arbitration Association.

Notwithstanding the above, the Owner may, at the Owner’s sole discretion, elect to resolve disputes in excess of \$50,000 by litigation, if mediation is not successful.

15.3.2 In the event of arbitration or litigation arising out of the execution of this Agreement, the prevailing party shall be entitled to recover from the adverse party, reasonable attorney fees and costs for the arbitration proceedings, trial court or any appellate proceeding, in the amount determined by the arbitrator or the court, as appropriate.

For the purposes of the above provisions referring to attorney fees and related costs, the prevailing party in an arbitration proceeding or trial shall be a claimant who receives an award or damages in excess of the adverse party’s pretrial or prehearing offer made at least 10 days before trial or hearing. If the claimant receives an award of damages no greater than the adverse party’s pretrial or prehearing offer, the adverse party shall be deemed to be the prevailing party. In the event both sides are awarded damages, the prevailing party shall be the party who recovers the net award, provided the recovery exceeds the adverse party’s pretrial or prehearing offer. If the claimant net recovery is no greater than the adverse party’s pretrial or prehearing offer, the adverse party shall be deemed the prevailing party.

**D. 15.4 ARBITRATION**

1. Delete Paragraph 15.4 ARBITRATION.

END OF DOCUMENT 00 73 00

**DOCUMENT 00 73 43**

**PREVAILING WAGE RATES**

**PART 1 GENERAL**

The Prevailing Wage Rates dated January 1, 2016, including any subsequent corrections or amendments issued by the Oregon Bureau of Labor and Industries, are included as a portion of the Contract Documents by reference. Copies are available for review at the office of Facilities Management, Eugene School District 4J, and can be viewed on line at [www.boli.state.or.us](http://www.boli.state.or.us). Click on Prevailing Wages, then PWR Rate Publications, and then Prevailing Wage Rates for Public Works Contracts in Oregon (subject only to state law).

END OF DOCUMENT 00 73 43



**SECTION 01 11 00**  
**SUMMARY OF WORK**

**PART 1 - GENERAL**

**1.1 RELATED DOCUMENTS**

- A. Drawings and general provisions of the Contract, including General and Supplementary Conditions and other Division 1 Specification Sections, apply to this Section.

**1.2 WORK COVERED BY CONTRACT DOCUMENTS**

- A. Project Identification: Project consists of selective demolition, removal and disposal of all asbestos-containing materials, PCB light ballasts, and mercury vapor light tubes at Roosevelt Middle School. This project is scheduled to be performed in one mobilization. Refer to HM 1 - HM 9 abatement diagrams for complete abatement information including materials, locations, and start and completion dates for each portion of the project.

1. Project Location: Roosevelt Middle School located at 680 E 24<sup>th</sup> Avenue, Eugene, Oregon.
2. Owner: Eugene School District 4J, 715 West Fourth Avenue, Eugene, OR 97402.

- B. Environmental Consultant: The Contract Documents, dated January 2016, were prepared for Project by:

PBS Engineering and Environmental  
2645 Willamette Street, Suite A  
Eugene, Oregon 97405

- C. Project Manager: Douglas Lemonds has been appointed by Owner to serve as Project Coordinator.

**D. BASE BID**

1. Work under this contract includes the removal of asbestos-containing materials, selective demolition, and related work. The specific scope of work follows below; refer to the attached drawings for additional information. Material quantities given are approximate. Contractor shall remove and dispose of all building finishes, mechanical equipment, loose furnishings, built-in casework and fixtures, and any other obstructions from the work areas to access concealed materials.

- a. Floor Tile and Mastic Abatement – Remove and dispose of all asbestos-containing floor tile and mastic throughout the building. The tile and mastic is concealed under other non-asbestos floor coverings in some locations, and is applied to concrete and wood product substrates. Floor tile is also concealed under some interior demising walls, and a wood stage. Refer to the abatement drawings for additional information and locations. Material quantities are as follows:

- 1) (+) floor tile and (+) mastic on concrete: 21,785 SF
- 2) (+) floor tile and (+) mastic on plywood/particleboard: 990 SF
- 3) (+) floor tile and (-) mastic on concrete: 13,855 SF
- 4) (+) floor tile and (-) mastic on plywood/particleboard: 920 SF
- 5) (-) floor tile and (+) mastic on concrete: 3,980 SF

## SUMMARY OF WORK – SECTION 01 11 00

- b. Sheet Floor Covering Abatement – Remove and dispose of all asbestos-containing sheet floor coverings throughout the building. The sheet flooring is concealed under other non-asbestos floor coverings in some locations, and is applied to concrete and wood product substrates. Material quantities are as follows:
  - 1) Concrete substrates: 710 SF
  - 2) Plywood/particleboard substrates: 60 SF
- c. Covebase and Mastic Abatement – Remove and dispose of all covebase and all associated mastics from the Kitchen, Serverly, Cafeteria, Custodial Office, and Girls Locker Room Entrance. Refer to the abatement drawings for additional information.
- d. Pipe Insulation Abatement – Remove and dispose of all asbestos-containing pipe and pipe fitting insulation, and all associated debris throughout the building. Concealed insulation is present in pipe chases, sub-slab trenches, wall cavities, and above ceilings. Contractor shall perform selective demolition as necessary to expose and abate concealed insulation above the concrete slab. Contractor shall coordinate with the District’s demolition contractor to access sub-slab pipe insulation. A summary of estimated quantities of asbestos-containing pipe insulation, and pipe fitting insulation on non-asbestos straight runs is provided below:
  - 1) Above-slab pipe insulation: 2,345 LF
  - 2) Above-slab pipe fitting insulation: 300 each
  - 3) Sub-floor crawlspace pipe fitting insulation: 12 each
  - 4) Sub-gym floor pipe insulation: 75 LF
  - 5) Sub-slab pipe insulation: 1,775 LF
  - 6) Sub-slab pipe and/or fitting insulation in cement asbestos tile sleeve: 405 LF
  - 7) Sub-grade pipe and/or fitting insulation wrapped in 15# felt: 125 LF
- e. Gypsum Board/Joint Compound/Wainscot Mastic Abatement – Remove and dispose of all gypsum board, asbestos-containing joint compound, and wainscot with asbestos-containing mastic throughout 1965 addition portions of the building. Refer to the abatement drawings for general locations. Contractor shall remove all fasteners and other appurtenances associated with the gypsum board systems. Portions of the gypsum board finishes are concealed behind other finish materials and fixtures. Multiple layers of gypsum board may be present in some areas. Material quantities are as follows:
  - 1) Gypsum board/joint compound: 9,625 SF
  - 2) Wainscot/mastic: 3,680 SF
- f. Cement Asbestos Board/Mastic Abatement – Remove and dispose of all cement asbestos board and all associated mastics throughout the building interior and exterior. A summary of CAB applications is provided below:
  - 1) Room A5 Loft (under windows): 170 SF (5 window units)
  - 2) 1965 Addition (under windows): 170 SF (22 window units)
  - 3) Library (under windows): 192 SF (12 window units)
- g. Cement Asbestos Chalkboard Abatement – Remove and dispose of all cement asbestos chalkboards from Rooms D4, D6, D7, D8, D9, and the Kitchen. Chalkboards are mostly concealed behind whiteboards and other wall hangings. A



## SUMMARY OF WORK – SECTION 01 11 00

total of 15 chalkboards are present. Up to two (2) additional assumed chalkboards and mastic are present in Room A5.

- h. Cement Asbestos Pipe Abatement – Remove and dispose of all cement asbestos pipe and cement asbestos tile throughout the building. These materials are primarily below concrete slabs and are installed as conduit for various pipes. Contractor shall coordinate with the District’s demolition contractor to access sub-slab cement asbestos pipe and tile. Estimated quantities are as follows:
  - 1) Sub-slab pipe conduit: 405 LF
  - 2) E-wing sub-slab tile: 140 LF
  - 3) Gas pipe penetration sleeves in A-wing: 10 LF
- i. Built-up Roofing Abatement – Remove and dispose of all asbestos-containing built-up roofing materials and all associated roofing insulation down to the wood roof deck over the following areas:
  - 1) Boys Gym, Boys Locker Room and Mechanical Penthouse: 10,820 SF
  - 2) Girls Gym, Stage, Southeast Corner Entrance: 7,180 SF
- j. Roof Penetration Sealant Abatement – Remove and dispose of all asbestos-containing sealants applied to various roof penetrations (vents, conduit, mechanical connections, etc.) throughout the building roof. Approximately 182 penetration points are present.
- k. Air Handling Unit Mastic Abatement – Remove and dispose of all asbestos-containing asphaltic mastic applied to the sheet metal interior of one HVAC air handling unit (MZ-2) located in the mechanical penthouse over the E-wing.
- l. Fire Door Abatement – Remove and dispose of all fire doors with assumed asbestos cores. The scope includes removal of 12 hinged fire doors and 6 rolling doors in main corridors.
- m. Theater Spot Light Wire Insulation Abatement – Remove and dispose of all asbestos-containing wire insulation on 11 spot lights located in and above Room E3.
- n. Window Glazing Compound Abatement: Remove and dispose of all asbestos containing window glazing compound and window glazing compound containing less than one percent asbestos. A summary of window types is presented below; refer to the abatement drawings for locations.
  - 1) (+) Glazing compound: 8 single-pane window units
  - 2) (<1%) Glazing compound: 123 3-pane window units
  - 3) (<1%) Glazing compound: 8 2-pane window units
- o. Pipe Flange Gasket Abatement – Remove and dispose of all assumed asbestos-containing gasket material concealed within pipe flange connections located in the boiler room and mechanical areas. Contractor shall assume up to 65 pipe flange connections will require abatement. Contractor may coordinate with the District’s demolition contractor in performing this abatement task.

## SUMMARY OF WORK – SECTION 01 11 00

- p. Louver Sealant Abatement – Remove and dispose of all asbestos-containing sealant material applied around two (2) louver openings in exterior walls of the boiler room and adjoining electrical room.
  - q. Mercury Switch Abatement – Remove and properly dispose of a total of six (6) mercury switches associated with boiler ancillary equipment in the Boiler Room.
  - r. Fluorescent Light Fixture Abatement – Inspect all fluorescent light fixtures throughout the facility for the presence of PCB-containing ballasts, and remove and properly dispose of all suspect PCB-containing ballasts. Leaking ballasts shall be handled in accordance with specifications and all state and federal regulations. Light fixture components with residual fluid from any leaking ballasts shall be removed and properly disposed of. All fluorescent light tubes are assumed to contain mercury. Contractor shall properly handle, remove and recycle all fluorescent light tubes, including stockpiled tubes. Approximately 1,240 light fixtures are present.
- 2. Contractor shall coordinate with the Owner to arrange for safely de-energizing all electrical fixtures prior to impact or removal.
  - 3. If suspect asbestos-containing materials are identified by the Contractor that are not identified in the abatement scope of work, all testing shall be conducted by the Owner. Contractor shall notify the Owner and the Owner shall provide sampling and analysis at the Owner's expense. Contractor is not authorized to collect or analyze bulk samples from Owner property.
  - 4. The Contractor and all sub-contractors under this contract performing abatement or demolition tasks on painted surfaces shall comply with all applicable lead paint regulations in OAR 437-Division 3, 1926.62 Lead in Construction Standard.

### 1.3 CONTRACT

- A. Project will be constructed under a general construction contract.
  - 1. Roosevelt Middle School - Asbestos Abatement

### 1.4 WORK SEQUENCE

- A. Do not commence Work until after execution of Agreement and receipt of Notice-to-Proceed from Owner.
- B. The Phase 1, Part 1 portion of the work is scheduled to start on June 23, 2016. Perform work in order to achieve Substantial Completion by June 30, 2016. Refer to the project phasing drawing for details regarding specific work tasks and areas that may deviate from this schedule.
- C. The Phase 1, Part 2 portion of the work is scheduled to start on June 24, 2016. Perform work in order to achieve Substantial Completion by July 17, 2016. Refer to the project phasing drawing for details regarding specific work tasks and areas that may deviate from this schedule.
- D. Achieve Final Completion within two (2) days following the date of Substantial Completion.



**1.5 USE OF PREMISES**

- A. Work Area Access: Adjacent portions of the building may be occupied during the work. Access to the work areas will be available 24 hours a day 7 day a week. Access to all other portions of the site must be coordinated with Owner so as not to interfere with Owner's use of the building.
- B. Limit use of the premises to construction activities in areas indicated; allow for Owner occupancy and use by the public, subject to approval by a District Safety Specialist.
- C. Site Access: Maintain drives and building entrances and exits clear and protected at all times to Owner's, employees, and public access and for use by emergency personnel. Do not use these areas for parking or storage. Schedule deliveries to minimize space and time requirements for storage of materials at site.
- D. Parking: A contractor parking area will be identified prior to start of project.
- E. Contractor Staging Areas: A staging area will be identified prior to start of project.

**1.6 WORK UNDER SEPERATE CONTRACTS**

- A. Separate Contract: Owner will award a separate contract for performance of certain construction operations at Project site. Those operations will be conducted simultaneously with work under this Contract.
- B. Cooperate fully with separate contractors so work on those contracts may be carried out smoothly, without interfering with or delaying work under this Contract.

**1.7 FUTURE WORK**

- A. Future Contract: Owner will award a separate contract for additional work to be performed at the site after Substantial Completion. Completion of that work will depend on successful completion of preparatory work under this Contract.

**1.8 PRODUCTS ORDERED IN ADVANCE**

- A. General: Owner has negotiated Purchase Orders with suppliers of material and equipment to be incorporated into the Work. Owner has assigned these Purchase Orders to Contractor. Costs for receiving, handling, storage if required, and installation of material and equipment are included in the Contract Sum.
  - 1. Contractor's responsibilities are the same as if Contractor had negotiated Purchase Orders, including responsibility to renegotiate purchase and to execute final Purchase-Order agreements.
  - 2. The Schedule of Products Ordered in Advance is included at the end of this Section.

**1.9 OWNER-FURNISHED PRODUCTS**

- A. Owner will furnish electric and water.
  - 1. Owner will arrange for and deliver Shop Drawings, Product Data, and Samples to Contractor.

2. Owner will arrange and pay for delivery of Owner-furnished items according to Contractor's Construction Schedule.
3. After delivery, Owner will inspect delivered items for damage. Contractor shall be present for and assist in Owner's inspection.
4. If Owner-furnished items are damaged, defective, or missing, Owner will arrange for replacement.
5. Contractor shall review Shop Drawings, Product Data, and Samples and return them to Architect noting discrepancies or anticipated problems in use of product.
6. Contractor is responsible for receiving, unloading, and handling Owner-furnished items at Project site.
7. Contractor is responsible for protecting Owner-furnished items from damage during storage and handling, including damage from exposure to the elements.
8. If Owner-furnished items are damaged as a result of Contractor's operations, Contractor shall repair or replace them.

**1.10 MISCELLANEOUS PROVISIONS**

**A. DRUG AND ALCOHOL POLICY**

1. The possession, use, or distribution of illicit drugs and alcohol on school premises is prohibited. Prescription medications brought to the project site shall be in the original container bearing the name of the drug, the name of the physician and the prescribed dosage.

**B. USE OF TOBACCO PRODUCTS**

1. Smoking and the other use of tobacco products is prohibited on all school district property pursuant to OAR 581-021-0110.

**C. SAFETY REQUIREMENTS**

1. Safety must not be sacrificed for the sake of productivity or expedience. Safety of students, staff, and the public is critical. Take all reasonable precautions to prevent endangerment or injury. Advise and coordinate operations with the school office.
2. All contractors who perform work on District property, and their employees, are expected to know the District's expectations for safe work and to adhere to those expectations.
3. Contractor's are to adhere to the regulations of Oregon OSHA for all projects within the School District.

**D. GENERAL SAFE WORK PRACTICES**

1. Students, public and school staff shall not be put at risk by the activities of contractors or their employees.
2. Safe vehicle operation rules are to be followed at all times. These include positioning vehicles to minimize the necessity of backing and providing a "spotter", someone who will make sure that people do not run into the path of a vehicle when driving on a playground or field that is occupied by students.
3. Tools shall never be left out when an unsecured work area is vacated.
4. Ladders and scaffolding will be taken down when an unsecured work area is vacated.
5. Open holes and other tripping hazards shall be fenced or barricaded when an unsecured work area is vacated.
6. Operations resulting in vapors, emissions or flying objects shall be conducted in such a way as to prevent exposure to any unprotected parties or property.



## SUMMARY OF WORK – SECTION 01 11 00

7. "Secured Work Area" is defined as an area having a perimeter cyclone fence at least 6 feet in height, with gates which close and lock so that no casual entrance is possible by unauthorized adults or children.
  8. Contractor to follow all OR-OSHA rules for Confined Spaces, where applicable.
- E. COMMUNICATIONS REGARDING UNSAFE PRACTICES
1. Upon perceiving a problem, the District will immediately communicate the concern to the Contractor or Contractor's representative on the work site.
  2. If agreement on correction of unsafe conditions cannot be reached, the concerns of the District shall prevail and safety concerns shall be addressed in accordance with the District requirements.
- F. ELECTRICAL PANELS - LOCKOUT/TAGOUT
1. Contractor shall implement a Lockout/Tag-out program for his employees who take equipment out of service or place equipment back into service. Contractor shall review the District's Energy Control Program prior to commencing work. Rules applying to this procedure are Oregon Occupational Safety and Health Code OAR 437, Division 2, Subdivision J, General Environmental Controls Lockout/Tag-out (1919.147), or latest edition.
- G. ARC FLASH – ELECTRICAL SAFETY
1. Contractor shall comply with NFPA 70E (Electrical Safety in the Workplace), current edition. Contractor shall comply with Oregon OSHA 1910.137 (Personal Protective Equipment). The Contractor shall review with the School District Project Manager the 'Eugene School District Electrical Safety Program' before any work commences. The Contractor shall comply with all 'Arc Flash' and 'Electrical Safety' protocols referenced in any and all NFPA, OSHA, OROSHA, NEC, NESC, UL, IBC, IFC and ANSI documents (current editions).
- H. POTENTIALLY HAZARDOUS PRODUCTS
1. The District attempts to maintain a safe and healthy environment for students and staff. The Contractor is therefore required to follow District guidelines controlling the use of potentially hazardous products and to use these products in a safe manner. Guidelines include the use of materials (adhesives, coatings, carpeting, etc.) which are known to emit little or no airborne pollutants.
  2. MSDS information is required for all potentially hazardous products. The Project Manager and a District Safety Specialist will review these and determine what, if any, mitigation procedures will be required.
  3. Contractor is to maintain and post copies of all MSDS information at the project site and adhere to the required controls.
  4. Contractor is to ensure that work area by students and teachers is restricted. The District will provide signage appropriate for this purpose. The Contractor is to construct and maintain appropriate barriers. This shall include provision of physical separation barriers between "construction" and "occupied" spaces.
  5. Contractor to adopt means of maintaining the construction space in negative air pressure in relation to occupied spaces.
  6. ~~Where there is a new or existing ventilation system in an affected space, the system shall be adjusted to provide the maximum amount of outside air possible with the system.~~
  7. ~~Efforts shall be made to install and operate new ventilation systems as soon in the construction process as practical.~~

**SUMMARY OF WORK – SECTION 01 11 00**

**I. ASBESTOS CONTAINING MATERIALS WARNING**

1. Contractor must not install any asbestos-containing materials when performing the Work of this project. At the completion of the Work, Contractor will be required to furnish a statement stating that no asbestos-containing materials were installed during the course of the Work. Refer to Sample Form 01 11 00B at the end of this Section.

**J. FULL TIME CERTIFIED SUPERVISOR DISCLOSURE STATEMENT**

1. Prior to or in conjunction with the Preconstruction Conference, the Contractor shall submit the disclosure statement which identifies the Full Time Certified Supervisor for this Project. The form for this statement, Form 01 11 00C, is provided at the end of this Section.

**K. BACKGROUND CHECK**

1. All Contractors, Contractor employees and sub contractors employees that will be working on District jobs will be required to fill out and submit a background check by logging on the following site <http://www.helpcounter.net/eugene>.

PART 2 - PRODUCTS (Not Used)

PART 3 - EXECUTION (Not Used)

PART 4 - SCHEDULE OF PRODUCTS ORDERED IN ADVANCE

PART 5 - ASBESTOS FORMS



Form 01 11 00 C

FULL TIME CERTIFIED SUPERVISOR DISCLOSURE STATEMENT

Prior to or in conjunction with the Preconstruction Conference, the Contractor shall submit this disclosure statement which identifies the Full Time Certified Supervisor for this Project.

Project Title: Roosevelt Middle School – Asbestos Abatement  
Eugene School District 4J  
Eugene, Oregon  
CIP No. 410.566.001

CONTRACTOR INFORMATION

Company Name: \_\_\_\_\_  
Company Address: \_\_\_\_\_  
City, State, Zip: \_\_\_\_\_

List below the name, address, telephone, cellular phone number, and e-mail address (if available) for the Full Time Certified Supervisor for this Project:

Supervisor’s Name: \_\_\_\_\_  
Address: \_\_\_\_\_  
(if different from Contractor’s) \_\_\_\_\_  
Phone: \_\_\_\_\_ Fax: \_\_\_\_\_  
Cell: \_\_\_\_\_ e-mail \_\_\_\_\_

The undersigned acknowledges that this project requires and will provide a Full Time Certified Supervisor throughout this project.

Signature: \_\_\_\_\_  
Authorized Signature  
Printed Name: \_\_\_\_\_  
Title: \_\_\_\_\_

Signature Notarized by:

Subscribed and sworn before me this \_\_\_\_\_ day of \_\_\_\_\_, 20\_\_.

Notary Public: \_\_\_\_\_  
Signature

My commission expires: \_\_\_\_\_

END OF SECTION 01 11 00

**SECTION 01 25 00**  
**CONTRACT MODIFICATION PROCEDURES**

**PART 1 - GENERAL**

**1.1 RELATED DOCUMENTS**

- A. Drawings and general provisions of the Contract, including General and Supplementary Conditions and other Division 1 Specification Sections, apply to this Section.

**1.2 SUMMARY**

- A. This Section specifies administrative and procedural requirements for handling and processing Contract modifications.
- B. Related Sections include the following:
  - 1. Division 0 Document 00 52 13 "Form of Agreement" for monetary values of established Unit Prices and Alternates.
  - 2. Division 0 Document 00 72 13 "General Conditions" for additional requirements for Changes in the Work, Contract Sum, and Contract Time.
  - 3. Division 1 Section 00 11 13 "Supplementary Conditions" for allowable percentages for Contractors' Overhead and Profit.
  - 4. Division 1 Section 01 33 00 "Submittal Procedures" for Schedule of Values requirements.
  - 5. Division 1 Section 01 60 00 "Product Requirements" for administrative procedures for handling requests for substitutions made after Contract award.

**1.3 MINOR CHANGES IN THE WORK**

- A. Architect, with the concurrence of the Owner, will issue supplemental instructions authorizing Minor Changes in the Work, not involving adjustment to the Contract Sum or the Contract Time.

**1.4 CHANGE REQUEST/PROCEED ORDER (CONSTRUCTION CHANGE DIRECTIVE)**

- A. Architect or Owner may issue a Change Request/Proceed Order on form included at end of Part 3.
  - 1. Change Request contains a complete description of change in the Work. It also designates method to be followed to determine change in the Contract Sum or the Contract Time.
  - 2. Proceed Order, when signed by the Owner, instructs Contractor to proceed with a change in the Work, for subsequent inclusion in a Change Order.
- B. Documentation: Maintain detailed records on a time and material basis of work required by the Proceed Order.
  - 1. After completion of change, submit an itemized account and supporting data necessary to substantiate cost and time adjustments to the Contract.

## CONTRACT MODIFICATION PROCEDURES – SECTION 01 25 00

- C. Authorization Required: When a Change Request is approved and signed by the Owner, it becomes a Proceed Order authorizing the change requested. Do not proceed with any change without the Owner's signature on the Change Request/Proceed Order.
- D. Owner-Initiated Change Requests: Architect will issue a Change Request, which will include a detailed description of proposed changes in the Work that may require adjustment to the Contract Sum or the Contract Time. If necessary, the description will include supplemental or revised Drawings and Specifications.
1. Change Requests issued by Architect are for information only. Do not consider them instructions either to stop work in progress or to execute the proposed change.
  2. Within time specified in Change Request after receipt of Change Request, submit a quotation estimating cost adjustments to the Contract Sum and the Contract Time necessary to execute the change.
    - a. Include a complete cost breakdown including a list of quantities of products required or eliminated and unit costs, with total amount of purchases and credits to be made. If requested, furnish survey data to substantiate quantities.
    - b. Indicate applicable taxes, delivery charges, equipment rental, and amounts of trade discounts.
    - c. Include costs of labor, supervision, overhead, and profit directly attributable to the change.
    - d. Include an updated Contractor's Construction Schedule that indicates the effect of the change, including, but not limited to, changes in activity duration, start and finish times, and activity relationship. Use available total float before requesting an extension of the Contract Time.
- E. Contractor-Initiated Requests: If latent or unforeseen conditions require modifications to the Contract, Contractor may propose changes by submitting a request for a change to the Architect.
1. Changes requested by the Contractor will be authorized only by signature of the Owner on the prescribed. Do not proceed with any changes without this authorization.
  2. Include a statement outlining reasons for the change and the effect of the change on the Work. Provide a complete description of the proposed change. Indicate the effect of the proposed change on the Contract Sum and the Contract Time.
  3. Include a list of quantities of products required or eliminated and unit costs, with total amount of purchases and credits to be made. If requested, furnish survey data to substantiate quantities.
  4. Indicate applicable taxes, delivery charges, equipment rental, and amounts of trade discounts.
  5. Include costs of labor, supervision, overhead, and profit directly attributable to the change.
  6. Include an updated Contractor's Construction Schedule that indicates the effect of the change, including, but not limited to, changes in activity duration, start and finish times, and activity relationship. Use available total float before requesting an extension of the Contract Time.
  7. Comply with requirements in Division 1 Section 01 60 00 "Product Requirements" if the proposed change requires substitution of one product or system for product or system specified.



**CONTRACT MODIFICATION PROCEDURES – SECTION 01 25 00**

- F. Change Request Form: Use forms provided by Owner. Sample copies are included at end of Section 3.

1.5 CHANGE ORDER PROCEDURES

- A. On Owner's approval of a Change Request, and at intervals to be determined, Architect will collect Change Requests and issue a Change Order for signatures of Owner and Contractor on AIA Document G701.

PART 2 - PRODUCTS (Not Used)

PART 3 - EXECUTION

**CHANGE REQUEST/PROCEED ORDER**

2011-2018 Capital Improvement Program  
Eugene School District 4J

.....  
**CHANGE REQUEST NOTICE**

Change Request No.: \_\_\_\_\_

Project No.: \_\_\_\_\_ Contract No.: \_\_\_\_\_ Date: \_\_\_\_\_

Project Title: \_\_\_\_\_

Contractor: \_\_\_\_\_

**1. REQUEST INFORMATION**

Estimated \$ \_\_\_\_\_ Time \_\_\_\_\_ Days \_\_\_\_\_ Initiated by \_\_\_\_\_

Reason for change: \_\_\_\_\_  
\_\_\_\_\_

**2. DESCRIPTION**

Describe changes: \_\_\_\_\_  
\_\_\_\_\_

Describe affected work: \_\_\_\_\_

List plan and spec sections: \_\_\_\_\_

Describe impacted activities: \_\_\_\_\_

Comment: \_\_\_\_\_

**3. DATES**

Need for change first known \_\_\_\_\_ By whom \_\_\_\_\_

Contractor first notified \_\_\_\_\_ How \_\_\_\_\_

Owner first notified \_\_\_\_\_

Date approved or rejected \_\_\_\_\_ By whom \_\_\_\_\_

**4. RECOMMENDATION (cost and time)** \_\_\_\_\_

.....  
**PROCEED ORDER**

PROCEED ORDER NO.: \_\_\_\_\_

Date: \_\_\_\_\_

**1. PAYMENT/COST**

Actual amount of change \$ \_\_\_\_\_

The contract time will be:

Contractor amount \$ \_\_\_\_\_

( ) increased ( ) decreased by \_\_\_\_\_ days

Subcontractor amount \$ \_\_\_\_\_

( ) will remain unchanged

Type of payment (LS/T&M) \_\_\_\_\_

**2. MISCELLANEOUS**

Subcontractors involved: \_\_\_\_\_

Major materials: \_\_\_\_\_

The cost is not to exceed \$ \_\_\_\_\_

Date: \_\_\_\_\_

**3 CHANGE REQUEST ACCEPTED BY:**

Contractor: \_\_\_\_\_

Date: \_\_\_\_\_

Architect: \_\_\_\_\_

Date: \_\_\_\_\_

4J CIP Project Manager: \_\_\_\_\_

Date: \_\_\_\_\_

4J CIP Program Manager: \_\_\_\_\_

Date: \_\_\_\_\_

4J Facilities Director: \_\_\_\_\_

Date: \_\_\_\_\_

Without the signature of Facilities Director, or the acting Director, this Proceed Order is neither accepted or authorized, except by written authorization of other specific delegation.

END OF SECTION 01250

**SECTION 01 29 00**  
**PAYMENT PROCEDURES**

**PART 1 - GENERAL**

**1.1 RELATED DOCUMENTS**

- A. Drawings and general provisions of the Contract, including General and Supplementary Conditions and other Division 1 Specification Sections, apply to this Section.

**1.2 SUMMARY**

- A. This Section specifies administrative and procedural requirements necessary to prepare and process Applications for Payment.
- B. Related Sections include the following:
  - 1. Division 1 Section 01 25 00 "Contract Modification Procedures" for administrative procedures for handling changes to the Contract.
  - 2. Division 1 Section 01 77 00 "Closeout Procedures" for final Application for Payment.

**1.3 DEFINITIONS**

- A. Schedule of Values: A statement furnished by Contractor allocating portions of the Contract Sum to various portions of the Work and used as the basis for reviewing Contractor's Applications for Payment.

**1.4 SCHEDULE OF VALUES**

- A. Coordination: Coordinate preparation of the Schedule of Values with preparation of Contractor's Construction Schedule.
  - 1. Correlate line items in the Schedule of Values with other required administrative forms and schedules, including the following:
    - a. Application for Payment forms with Continuation Sheets.
    - b. Submittals Schedule.
    - c. Contractor's Construction Schedule.
  - 2. Submit the Schedule of Values to Architect and Owner at earliest possible date but no later than seven days before the date scheduled for submittal of initial Application for Payment.
- B. Format and Content: Use the Project Manual table of contents as a guide to establish line items for the Schedule of Values. Provide at least one line item for each Specification Section.
  - 1. Identification: Include the following Project identification on the Schedule of Values:
    - a. Project name and location.
    - b. Name of Architect.



## PAYMENT PROCEDURES – SECTION 10 29 00

- c. Architect's project number.
  - d. Contractor's name and address.
  - e. Date of submittal.
2. Submit draft of AIA Document G703 Continuation Sheets.
  3. Provide a breakdown of the Contract Sum in enough detail to facilitate continued evaluation of Applications for Payment and progress reports. Coordinate with the Project Manual table of contents. Provide several line items for principal subcontract amounts, where appropriate.
  4. Round amounts to nearest whole dollar; total shall equal the Contract Sum.
  5. Provide a separate line item in the Schedule of Values for each part of the Work where Applications for Payment may include materials or equipment purchased or fabricated and stored, but not yet installed.
    - a. Differentiate between items stored on-site and items stored off-site. If specified, include evidence of insurance or bonded warehousing.
  6. Provide separate line items in the Schedule of Values for initial cost of materials, for each subsequent stage of completion, and for total installed value of that part of the Work.
  7. Allowances: Provide a separate line item in the Schedule of Values for each allowance. Show line-item value of unit-cost allowances, as a product of the unit cost, multiplied by measured quantity. Use information indicated in the Contract Documents to determine quantities.
  8. Each item in the Schedule of Values and Applications for Payment shall be complete. Include total cost and proportionate share of general overhead and profit for each item.
    - a. Temporary facilities and other major cost items that are not direct cost of actual work-in-place may be shown either as separate line items in the Schedule of Values or distributed as general overhead expense, at Contractor's option.
  9. Schedule Updating: Update and resubmit the Schedule of Values before the next Applications for Payment when Change Orders or Construction Change Directives result in a change in the Contract Sum.

### 1.5 APPLICATIONS FOR PAYMENT

- A. Each Application for Payment shall be consistent with previous applications and payments as certified by Architect and paid for by Owner.
  1. Initial Application for Payment, Application for Payment at time of Substantial Completion, and final Application for Payment involve additional requirements.
- B. Payment Application Forms: Use AIA Document G702 and AIA Document G703 Continuation Sheets as form for Applications for Payment.
- C. Application Preparation: Complete every entry on form. Notarize and execute by a person authorized to sign legal documents on behalf of Contractor. Architect will return incomplete applications without action.

## **PAYMENT PROCEDURES – SECTION 10 29 00**

1. Entries shall match data on the Schedule of Values and Contractor's Construction Schedule. Use updated schedules if revisions were made.
  2. Include amounts of Change Orders issued before last day of construction period covered by application.
  3. Transmittal: Submit 3 signed and notarized original copies of each Application for Payment to Architect by a method ensuring receipt within 24 hours.
- D. Initial Application for Payment: Administrative actions and submittals that must precede or coincide with submittal of first Application for Payment include the following:
1. List of subcontractors.
  2. Schedule of Values (draft submitted previously).
  3. Contractor's Construction Schedule (preliminary if not final).
  4. Products list.
  5. Schedule of unit prices.
  6. Submittals Schedule (based Architect's list or required submittals).
  7. List of Contractor's staff assignments.
  8. Initial progress report.
  9. Report of preconstruction conference.
- E. Application for Payment at Substantial Completion: After Architect issues the Certificate of Substantial Completion, submit an Application for Payment showing 100 percent completion for portion of the Work claimed as substantially complete.
1. Include documentation supporting claim that the Work is substantially complete and a statement showing an accounting of changes to the Contract Sum.
  2. This application shall reflect Certificates of Partial Substantial Completion issued previously for Owner occupancy of designated portions of the Work.
- F. Final Payment Application: Submit final Application for Payment with releases and supporting documentation not previously submitted and accepted, including, but not limited, to the following:
1. Evidence of completion of Project closeout procedures (See itemized list in Section 01 77 00 "Closeout Procedures").
  2. Updated final statement, accounting for final changes to the Contract Sum.
  3. AIA Document G706, "Contractor's Affidavit of Payment of Debts and Claims."
  4. AIA Document G706A, "Contractor's Affidavit of Release of Liens."
  5. AIA Document G707, "Consent of Surety to Final Payment."
  6. Evidence that claims have been settled.
  7. Final, liquidated damages settlement statement.

PART 2 - PRODUCTS (Not Used)

PART 3 - EXECUTION (Not Used)

END OF SECTION 10 29 00

**SECTION 01 31 00**  
**PROJECT MANAGEMENT AND COORDINATION**

**PART 1 - GENERAL**

**1.1 RELATED DOCUMENTS**

- A. Drawings and general provisions of the Contract, including General and Supplementary Conditions and other Division 1 Specification Sections, apply to this Section.

**1.2 SUMMARY**

- A. This Section includes administrative provisions for coordinating construction operations on Project including, but not limited to, the following:
  - 1. Administrative and supervisory personnel.
  - 2. Project meetings.
- B. Related Sections include the following:
  - 1. Division 1 Section 01 73 00 "Execution Requirements" for procedures for coordinating general installation and field-engineering services, including establishment of benchmarks and control points.
  - 2. Division 1 Section 01 77 00 "Closeout Procedures" for coordinating Contract closeout.

**1.3 COORDINATION**

- A. Coordination: Coordinate construction operations included in different Sections of the Specifications to ensure efficient and orderly installation of each part of the Work. Coordinate construction operations, included in different Sections that depend on each other for proper installation, connection, and operation.
  - 1. Schedule construction operations in sequence required to obtain the best results where installation of one part of the Work depends on installation of other components, before or after its own installation.
  - 2. Coordinate installation of different components with other contractors to ensure maximum accessibility for required maintenance, service, and repair.
  - 3. Make adequate provisions to accommodate items scheduled for later installation.
  - 4. Where availability of space is limited, coordinate installation of different components to ensure maximum performance and accessibility for required maintenance, service, and repair of all components, including mechanical and electrical.
- B. Prepare memoranda for distribution to each party involved, outlining special procedures required for coordination. Include such items as required notices, reports, and list of attendees at meetings.
  - 1. Prepare similar memoranda for Owner and separate contractors if coordination of their Work is required.



## PROJECT MANAGEMENT AND COORDINATION – SECTION 00 31 00

- C. Administrative Procedures: Coordinate scheduling and timing of required administrative procedures with other construction activities and activities of other contractors to avoid conflicts and to ensure orderly progress of the Work. Such administrative activities include, but are not limited to, the following:
1. Preparation of Contractor's Construction Schedule.
  2. Preparation of the Schedule of Values.
  3. Installation and removal of temporary facilities and controls.
  4. Delivery and processing of submittals.
  5. Progress meetings.
  6. Preinstallation conferences.
  7. Project closeout activities.
  8. Startup and adjustment of systems.
  9. Project closeout activities.
- D. Conservation: Coordinate construction activities to ensure that operations are carried out with consideration given to conservation of energy, water, and materials.
1. Salvage materials and equipment involved in performance of, but not actually incorporated into, the Work. Refer to other Sections for disposition of salvaged materials that are designated as Owner's property.

### 1.4 SUBMITTALS

- A. Key Personnel Names: Within 15 days of Notice-to-Proceed, submit a list of key personnel assignments, including superintendent and other personnel in attendance at Project site. Identify individuals and their duties and responsibilities; list addresses and telephone numbers, including pager, cell, and office telephone numbers. Provide names, addresses, and telephone numbers of individuals assigned as standbys in the absence of individuals assigned to Project.

### 1.5 PROJECT MEETINGS

- A. General: Schedule and conduct meetings and conferences at Project site, unless otherwise indicated.
1. Attendees: Inform participants and others involved, and individuals whose presence is required, of date and time of each meeting. Schedule meeting dates and times with Owner and Architect.
  2. Agenda: Prepare the meeting agenda. Distribute the agenda to all invited attendees.
  3. Minutes: Architect will record significant discussions and agreements achieved. Distribute the meeting minutes to everyone concerned, within three days of receiving them from the Architect.
- B. Preconstruction Conference: Owner's Project Manager will schedule a preconstruction conference before starting construction, no later than 15 days after execution of the Agreement. Hold the conference at Project site or another convenient location. Conduct the meeting to review responsibilities and personnel assignments.
1. Attendees: Owner's Project Manager, Architect, and their consultants, as required; Contractor and its superintendent; major subcontractors; suppliers; and other concerned

## PROJECT MANAGEMENT AND COORDINATION – SECTION 00 31 00

parties shall attend the conference. All participants at the conference shall be familiar with Project and authorized to conclude matters relating to the Work.

2. Agenda: Discuss items of significance that could affect progress, including the following (see sample agenda at the end of Part 3):

- a. Introduction of persons present.
- b. Tentative construction schedule.
- c. Phasing.
- d. Critical work sequencing and long-lead items.
- e. Designation of key personnel and their duties.
- f. Procedures for processing field decisions and Change Orders.
- g. Procedures for requests for interpretations (RFIs).
- h. Procedures for testing and inspecting.
- i. Procedures for processing Applications for Payment.
- j. Distribution of the Contract Documents.
- k. Communications.
- l. Role of District's Project Manager.
- m. Submittal procedures, including MSDS information.
- n. Energy design requirements.
- o. Preparation of Record Documents.
- p. Use of the premises and existing building.
- q. Work hours and restrictions.
- r. Owner's occupancy requirements.
- s. Responsibility for temporary facilities and controls.
- t. Construction waste management and recycling.
- u. Parking availability.
- v. Office, work, and storage areas.
- w. Equipment deliveries and priorities.
- x. Safety and first aid.
- y. Security.
- z. Progress cleaning.

3. Minutes: Architect will record and distribute meeting minutes.
4. Statements made by the Contracting Agency's representative at the pre-construction conference are not binding upon the Contracting Agency unless confirmed by Written Addendum.

- C. Preinstallation Conferences: When required by individual specification sections, conduct a preinstallation conference at Project site before each construction activity that requires coordination with other construction.

1. Attendees: Installer and representatives of manufacturers and fabricators involved in or affected by the installation and its coordination or integration with other materials and installations that have preceded or will follow, shall attend the meeting. Advise Architect and Owner's Project Manager a minimum of four days prior to scheduled meeting dates.
2. Agenda: Review progress of other construction activities and preparations for the particular activity under consideration, including requirements for the following:
  - a. Contract documents.
  - b. Related requests for interpretations (RFIs).
  - c. Related Change Orders.

**PROJECT MANAGEMENT AND COORDINATION – SECTION 00 31 00**

- d. Purchases.
  - e. Deliveries.
  - f. Submittals.
  - g. Possible conflicts.
  - h. Compatibility problems.
  - i. Time schedules.
  - j. Weather limitations.
  - k. Manufacturer's written recommendations.
  - l. Warranty requirements.
  - m. Compatibility of materials.
  - n. Acceptability of substrates.
  - o. Space and access limitations.
  - p. Regulations of authorities having jurisdiction.
  - q. Testing and inspecting requirements.
  - r. Installation procedures.
  - s. Coordination with other work.
  - t. Required performance results.
  - u. Protection of adjacent work.
- 3. Contractor to record significant conference discussions, agreements, and disagreements, including required corrective measures and actions.
  - 4. Distribute minutes of the meeting to each party present and to parties who should have been present, within three working days.
  - 5. Do not proceed with installation if the conference cannot be successfully concluded. Initiate whatever actions are necessary to resolve impediments to performance of the Work and reconvene the conference at earliest feasible date.
- D. Progress Meetings: Conduct progress meetings at weekly intervals. Coordinate dates of meetings with preparation of payment requests.
- 1. Attendees: In addition to the Owner's Project Manager and Architect, each contractor, subcontractor, supplier, and other entity concerned with current progress or involved in planning, coordination, or performance of future activities shall be represented at these meetings. All participants at the conference shall be familiar with Project and authorized to conclude matters relating to the Work.
  - 2. Agenda: Review and correct or approve minutes of previous progress meeting. Review other items of significance that could affect progress. Include topics for discussion as appropriate to status of Project.
    - a. Contractor's Construction Schedule: Review progress since the last meeting. Determine whether each activity is on time, ahead of schedule, or behind schedule, in relation to Contractor's Construction Schedule. Determine how construction behind schedule will be expedited; secure commitments from parties involved to do so. Discuss whether schedule revisions are required to ensure that current and subsequent activities will be completed within the Contract Time.
    - b. Review present and future needs of each entity present, including the following:
      - 1) Interface requirements.
      - 2) Sequence of operations.
      - 3) Status of submittals.



**PROJECT MANAGEMENT AND COORDINATION – SECTION 00 31 00**

- 4) Deliveries.
  - 5) Off-site fabrication.
  - 6) Access.
  - 7) Site utilization.
  - 8) Temporary facilities and controls.
  - 9) Work hours.
  - 10) Hazards and risks.
  - 11) Progress cleaning.
  - 12) Quality and work standards.
  - 13) Status of correction of deficient items.
  - 14) Field observations.
  - 15) Requests for interpretations (RFIs).
  - 16) Status of proposal requests.
  - 17) Pending changes.
  - 18) Status of Change Orders.
  - 19) Pending claims and disputes.
  - 20) Documentation of information for payment requests.
3. Minutes: Architect will record and distribute to Contractor the meeting minutes.
  4. Reporting: Distribute minutes of the meeting to each party present and to parties who should have been present.

PART 2 - PRODUCTS (Not Used)

PART 3 - EXECUTION (Not Used)

**PRECONSTRUCTION CONFERENCE AGENDA**

Eugene School District 4J  
Roosevelt Middle School - Asbestos Abatement

Date:

AGENDA

1. ( ) Introduction of Persons Present
  - ( ) District 4J
  - ( ) Consultants
  - ( ) Contractor (including job foreman)
  - ( ) Subcontractors
  
2. ( ) Availability of Contract Documents
  
3. ( ) Building Permit Status
  - ( ) Plan check and Building Permit paid by District
  - ( ) Pick up Permit at City of Eugene by Contractor
  - ( ) Location of site stored approved contract documents
  - ( ) Utility permits
  - ( ) LRAPA Permit
  
4. ( ) Prevailing Wage Requirements
  - ( ) Submittal schedule
  - ( ) Conformance with requirements
  
5. ( ) Communications
  - ( ) Notification of problems
  
6. ( ) Role of District's representative
  - ( ) Limits of authority
  - ( ) Visitation schedules
  
7. ( ) Work Description and Schedule
  - ( ) General work description
  - ( ) Proposed start date: \_\_\_\_\_
  - ( ) Proposed completion date: \_\_\_\_\_
  - ( ) Proposed project schedule and phasing
  - ( ) Progress schedule updates
  - ( ) Methods to be employed to maintain schedule
  - ( ) Work requiring Shop Drawings or submittals shall not commence until review is complete.
  
8. ( ) Submittals Required per Contract Documents
  - ( ) MSDS Information
  - ( ) Written proof of Asbestos Worker Certification
  - ( ) Name, Experience and Qualifications of Asbestos Supervisor
  - ( ) Copy of Contractor's Asbestos Abatement License
  - ( ) Other information as required by Section 01 31 00.

**PROJECT MANAGEMENT AND COORDINATION – SECTION 00 31 00**

- Schedule of values
  - List of subcontractors including name of contact person, telephone number, and address
9.  Construction
- Working hours
  - Use of premises/set up locations
  - Protection of existing facilities
  - Traffic and protection
  - Excavation and clean-up
  - Weather restrictions
  - Deviation from details and/or specifications
10.  Correction of Defects
- Daily and/or as observed
11.  Weekly On-Site Progress Meetings
- Establish day and time: Day \_\_\_\_\_ Time \_\_\_\_\_
  - Provide updated project schedules
  - Discuss project progress, problems, etc.
  - Review applications for payment
  - Required attendance
  - Observation report distribution
12.  Change Order Requests and Change Order Procedures
- Written Change Order requests required
  - Supporting back-up will be required for all Change Orders
  - Mark-up limitations on Change Orders
    - Contractor - 15 percent
    - Subcontractors - 10 percent
  - Progressive requests and Change Orders
  - Processing time required
13.  Applications for Payment
- Use AIA documents G702 and G703 latest edition
  - Provide 5 signed and notarized copies
  - Wage certifications to be attached
14.  Safety and Emergency Procedures
15.  Clean-up Daily
- Project completion
16.  Project Closeout
- Inspections for
    - Air Clearance
    - AHERA Close Out Requirements
    - Substantial completion
      - Contractor provided list of items to be completed
      - Inspection with job foreman
    - Final Acceptance
      - Written notice from Contractor that all work is done and ready for inspection



**PROJECT MANAGEMENT AND COORDINATION – SECTION 00 31 00**

- Inspection with job foreman
- Responsibility for cost of additional inspections
- Submittals for Closeout
  - Final application for payment
  - Final set of wage certifications
  - Release of liens from all Subcontractors and general Contractor

17.  Tour of Project Sites to Examine and Document Existing Conditions

18.  Additional Comments

The undersigned acknowledges that the items listed above were discussed during this preconstruction conference and are fully understood.

Date:

A/E Firm:

Contractor:

Subcontractors:

END OF SECTION 01 31 00

## SECTION 01 33 00

### SUBMITTAL PROCEDURES

#### PART 1 - GENERAL

##### 1.1 RELATED DOCUMENTS

- A. Drawings and general provisions of the Contract, including Construction Contractor Agreement and Terms & Agreement and other Division 1 Specification Sections, apply to this Section.

##### 1.2 SUMMARY

- A. Related Sections include the following:
  1. Division 1 Section 001310 "Project Management and Coordination" for submitting and distributing meeting and conference minutes and for submitting Coordination Drawings.
  2. Division 1 Section 01400 "Quality Requirements" for submitting test and inspection reports and for mockup requirements, if any.
  3. Division 1 Section 01770 "Closeout Procedures" for submitting warranties.

##### 1.3 SUBMITTALS PRIOR TO COMMENCING WORK

- A. Insurance: Written proof that the Contractor carries the insurance required.
- B. Written proof that all employees are AHERA certified and Oregon State certified Full-Scale Asbestos Workers. Proof shall include copies of both sides of each Workers' Oregon State Asbestos Removal and Supervisor cards. All cards must be current.
- C. The name and resume of experience of the assigned on-site Supervisor. At a minimum, the supervisor shall have completed a DEQ Asbestos Supervisor Course as approved by the State of Oregon. Other criteria, such as references and similar projects, shall be included for review. At the School District's option, the School District may arrange an oral interview with the Asbestos Supervisor. **The School District reserves the right to reject the Supervisor at any time during the project.** The Contractor shall then assign another on-site Supervisor for the District's approval as described above.
- D. Written proof that the asbestos abatement contractor is currently, and for the duration of the project, licensed in the State of Oregon to perform asbestos abatement, per ORS Chapter 701 and ORS 340, Division 23.
- E. A written emergency control and clean-up plan to be followed by the Contractor in the event that fiber counts are in excess of those specified in Section 02080.
- F. A written respiration program in compliance with all parts of OSHA Asbestos Regulations CPR Title 29, Part 1910, Section 1910.1001.
- G. Information pertaining to the proposed Air Monitoring Program for this Project. This information shall include name(s) of on-site Monitoring Technician(s), types of equipment sampling procedures, calibration record-keeping, and the Testing Laboratory to be used. Provide written proof that Testing Laboratory, laboratory personnel, analytical procedures, and

quality control procedures are in compliance with CFR 29, Section 1926.58, including Appendices A and B.

- H. Manufacturer's certification that vacuums, ventilation equipment, and other equipment required to contain airborne fibers conform to ANSI Z9.2.
- I. Written medical exam program per OSHA Asbestos Regulations CFR Title 29, part 1926.58.
- J. Copy of Notice of Intent to Encapsulate or Remove Asbestos, submitted to Lane Regional Air Pollution Authority with evidence of payment of fees.
- K. Legible copies of MSDS sheets for all products the Contractor intends to use on this Project.
- L. Written proof that all required permits and arrangements for transport and dispose of asbestos-containing or contaminated materials have been obtained and materials will be disposed of at a site approved by EPA and other governmental agencies having jurisdiction.
- M. Schedule for asbestos abatement showing decontamination procedures, plans for construction and location of decontamination enclosure systems, negative pressure fans, etc., in compliance with these Specifications and all applicable regulations. Schedule shall show systematic flow of work throughout the facility on a day-by-day, room-by-room or area-by-area basis. Closely coordinate the work with the District.

#### 1.4 SUBMITTALS FOLLOWING COMMENCEMENT OF WORK

- A. Information required above regarding any new asbestos workers hired by or subcontracted to, the Contractor before any new asbestos abatement workers begin work.
- B. Any amendments to the original LRAPA notification.
- C. Written identification to the District of any subcontractors or major suppliers.
- D. Air Monitoring test results for the previous day's work, submitted on a daily basis.
- E. On a Weekly basis:
  - 1. Copies of work-site entry logs.
  - 2. Logs documenting filter changes on respirators, HEPA vacuums, and air filtration machines.
  - 3. Daily logs filled out by the on-site Supervisor.

#### 1.5 FINAL SUBMITTALS

- A. Submit a summary of all abatement activities, outlining any changes from the original Scope-of-Work or problems encountered in completing the Work. Include the start and completion dates along with copies of all required submittals. Submit copies of all amended LRAPA notifications, all Asbestos Waste Shipment Records, completely filled out and signed as required by LRAPA, along with tickets or receipts from the disposal site, worker certifications for all workers who were involved with the Project, and all air monitoring data. Summary of Abatement Activities with Submittals, Worker and Supervisor Certifications for all workers on the Project, Air Monitoring Data, Complete list of Contractor and all Subcontractors with address, phone numbers, and work numbers.



**PART 2 - PRODUCTS**

Not used.

**PART 3 - EXECUTION**

Not used.

**END OF SECTION 01330**

## SECTION 01 40 00

### QUALITY REQUIREMENTS

#### PART 1 - GENERAL

##### 1.1 RELATED DOCUMENTS

- A. Drawings and general provisions of the Contract, including Construction Contractor Agreement and Terms & Conditions and other Division 1 Specification Sections, apply to this Section.

##### 1.2 SUMMARY

- A. This Section includes administrative and procedural requirements for quality assurance and quality control.
- B. Testing and inspecting services are required to verify compliance with requirements specified or indicated. These services do not relieve Contractor of responsibility for compliance with the Contract Document requirements.
  - 1. Specific quality-assurance and -control requirements for individual construction activities are specified in the Sections that specify those activities. Requirements in those Sections may also cover production of standard products.
  - 2. Specified tests, inspections, and related actions do not limit Contractor's other quality-assurance and -control procedures that facilitate compliance with the Contract Document requirements.
  - 3. Requirements for Contractor to provide quality-assurance and -control services required by Architect, Owner, or authorities having jurisdiction are not limited by provisions of this Section.

##### 1.3 CONFLICTING REQUIREMENTS

- A. General: If compliance with two or more standards is specified and the standards establish different or conflicting requirements for minimum quantities or quality levels, comply with the most stringent requirement. Refer uncertainties and requirements that are different, but apparently equal, to Architect for a decision before proceeding.
- B. Minimum Quantity or Quality Levels: The quantity or quality level shown or specified shall be the minimum provided or performed. The actual installation may comply exactly with the minimum quantity or quality specified, or it may exceed the minimum within reasonable limits. To comply with these requirements, indicated numeric values are minimum or maximum, as appropriate, for the context of requirements. Refer uncertainties to Architect for a decision before proceeding.

##### 1.4 AIR MONITORING BY CONTRACTOR

- A. An Independent Testing Laboratory shall be retained by the Contractor. All air monitoring analysis shall be performed by an Air Monitoring Technician. The Technician must be experienced and trained in asbestos sampling and analysis. At a minimum, documentation of prior asbestos sampling and analysis experience, plus satisfactory completion of the NIOSH 582 course or equivalent formal asbestos education, will be required. Air sample collection may be

performed by an Air Monitoring Technician or the Contractor's foreman at the Contractor's option.

- B. Documentation shall be kept for each filter sample procured as to worker sampled, work area location, date and time taken, volume of air drawn through filter, pump identification number and calibration. Documentation shall indicate in what areas tests were taken and shall clearly indicate the specified maximum allowable fiber levels for each area tested. Report all data on copies of "Asbestos Air Sampling Data Form" bound in these Specifications or similar form. Fill in all information on every form. Submit chain-of-custody records along with all samples.
- C. The samples shall be collected on 25 mm filters and analyzed within 12 hours using the membrane filter method at 400-500x magnification with phase contrast illumination--NIOSH Analytical Method No. 7400--for laboratory and field analysis. The analyst shall sign and submit permanent records of all samples analyzed directly to the Project Designer. The Independent Testing Laboratory shall seal the unused portion of all filters in airtight containers so that individual samples can be reanalyzed at a later date if necessary. The containers shall be clearly labeled with Project Name and Sample Number and shall become property of the School District at work completion at the School District's request.
- D. The Contractor's testing laboratory shall submit sample analysis results to the Project Designer verbally within 18 hours from the time of collection and written within two weeks including chain-of-custody and equipment calibration records.
- E. Contractor's Sampling During Abatement:
  - 1. Air monitoring shall be performed to provide the samples during the period of asbestos abatement in each work area. Sampling shall begin when asbestos removal commences, and performed during each 8-hour work shift until abatement is complete in that work area.
  - 2. The Contractor shall determine which worker(s) in each work area is likely to be experiencing the most severe exposure. This is the "Most Contaminated Worker(s)". 8-hour TWA and 30-minute excursion samples shall be collected on this worker(s). This worker shall wear a personal sampling pump and the sample shall be drawn from the breathing zone of this worker.
  - 3. The number of air samples shall be determined by the Contractor, and may be altered during the project based on work activity and results.
  - 4. The maximum allowable fiber levels shall be as determined by the Project Designer based on the respiratory protection being utilized.
- F. Contractor shall notify the Lane Regional Air Pollution Authority (LRAPA) of air monitoring clearance results as supplied by Air Monitoring Firm. Notification shall be within 30 days after monitoring procedures were performed in accordance to LRAPA 43-015-7.D.

#### 1.5 AIR MONITORING BY OWNER

- A. The School District will retain an experienced Air Monitoring Firm to collect and analyze asbestos air samples. The buildings are scheduled for demolition and will not be reoccupied. All air clearance testing will be performed according to LRAPA regulatory requirements.
- B. The School District will provide PCM air clearance monitoring. Documentation of sample results will be forwarded to the Contractor as appropriate to regulatory requirements.
- C. ~~The School District will provide TEM Air Clearance Monitoring for all locations in the Base Bid as appropriate to regulatory requirements. Any other TEM Air Clearance Monitoring will~~



~~be at the cost of the Abatement Contractor. Documentation of sample results will be forwarded to the Contractor as appropriate to regulatory requirements.~~

- D. Samples analyzed by Phase Contrast Microscopy will use NIOSH Analytical Method No. 7400. ~~Samples analyzed by Transmission Electron Microscopy will use the AHERA methodology, 40 CFR Part 763.~~
- E. School District's Air Sampling During and After Abatement:
  - 1. Air Sampling Table is to be used as a guide. The School District's Project Designer may modify criteria. Modifications to the Maximum Allowable Fiber Count shall be made in writing by the School District.

Type of Sample	Samples per 8-Hour Work Shift	Average Sample Volume in Liters (L)	Approximate Flow Rate	Maximum Allowable Fiber Count (f/cc)
HEPA Fan Exhaust	1 or selected units	400-2000 L	2-10 LPM	0.005 f/cc 0.005 s/cc
Outside of Work Area	1-5	400-2000 L	1 to 10 LPM	0.01 f/cc 0.01 s/cc
Clearance PCM	5	800-3000 L	1 to 10 LPM	0.01 f/cc
Clearance TEM	5	1200-1800 L	2 to 10 LPM	Average of 70s/mm <sup>2</sup>

- 2. To ensure the movement of air and the elevation of any remaining particulates within the work area enclosure while clearance sampling is occurring, the HEPA-filtered exhaust air machine(s) is to be in continuous operation.
- 3. Analysis of clearance samples shall be by Phase Contrast Microscopy (PCM) or Transmission Electron Microscopy (TEM) as appropriate. The z-test will not be utilized.
- 4. If additional sampling is required due to unsatisfactory clearance results, breeches in containment, etc. the Contractor shall bear all associated additional costs, including analysis, air monitoring costs, and shipping costs.
- 5. The School District reserves the right to monitor Contractor's performance via air samples on abatement, workers, and in the work area in addition to the Contractor's air monitoring.

## 1.6 QUALITY ASSURANCE

- A. If, at any time during the work, analysis of an air sample taken by the Contractor, School District, or School District's representative, indicates a fiber count in excess of the allowable maximums specified, the Air Monitoring Technician who analyzed the air sample shall immediately notify:
  - 1. The Contractor's Foreman
  - 2. School District's Asbestos Project Designer
- B. Immediately upon being notified of fiber count exceeding the specified maximum allowable levels, the Contractor shall perform the following steps in the order presented, at no additional cost to the School District:
  - 1. Stop abatement work.
  - 2. Discuss the fiber count, containment breeches, pressure differential changes, or other potential cause, and the School District. The Project Designer will determine the affected area and affected adjacent areas considered to be contaminated. The Project Designer

will determine the actions to be taken by the Contractor at no additional cost to the School District.

- a. Clean the affected area and the affected adjacent areas. Cleaning shall use wet methods and HEPA vacuuming.
  - b. Resample air until fiber counts are determined to be below one half of the specified maximum levels.
  - c. Secure and repair containment barriers, repair or add equipment.
  - d. Modify work procedures, and make other changes determined to be the possible cause of high fiber counts.
3. Complete every part of the "Fiber Count Above Control Limit Data Form" bound into these Specifications.
  4. Carefully resume work under close air monitoring.

#### 1.7 REPAIR AND PROTECTION

- A. General: On completion of testing, inspecting, sample taking, and similar services, repair damaged construction and restore substrates and finishes.
  1. Provide materials and comply with installation requirements specified in other Specification Sections. Restore patched areas and extend restoration into adjoining areas with durable seams that are as invisible as possible.
- B. Protect construction exposed by or for quality-control service activities.
- C. Repair and protection are Contractor's responsibility, regardless of the assignment of responsibility for quality-control services.

END OF SECTION 01400

**SECTION 01 50 00**  
**TEMPORARY FACILITIES AND CONTROL**

**PART 1 - GENERAL**

**1.1 RELATED DOCUMENTS**

- A. Drawings and general provisions of the Contract, including General and Supplementary Conditions and other Division 1 Specification Sections, apply to this Section.

**1.2 SUMMARY**

- A. This Section includes requirements for temporary utilities, support facilities, and security and protection facilities.
- B. Related Sections include the following:
  - 1. Division 1 Section 01 11 00 "Summary of Work" for limitations on utility interruptions and other work restrictions.
  - 2. Division 1 Section 01 33 00 "Submittal Procedures" for procedures for submitting copies of implementation and termination schedule and utility reports.
  - 3. Division 1 Section 01 77 00 "Execution Requirements" for progress cleaning requirements.
  - 4. Divisions 2 through 49 Sections for temporary heat, ventilation, and humidity requirements for products in those Sections.

**1.3 DEFINITIONS**

- A. Permanent Enclosure: As determined by Architect, permanent or temporary roofing is complete, insulated, and weathertight; exterior walls are insulated and weathertight; and all openings are closed with permanent construction or substantial temporary closures.

**1.4 USE CHARGES**

- A. General: Cost or use charges for temporary facilities shall be included in the Contract Sum. Allow other entities to use temporary services and facilities without cost, including, but not limited to, Owner's construction forces, Architect, testing agencies, and authorities having jurisdiction.

**1.5 SUBMITTALS**

- A. Site Plan: Show temporary facilities, utility hookups, staging areas, and parking areas for construction personnel.

**1.6 QUALITY ASSURANCE**

- A. Electric Service: Comply with NECA, NEMA, and UL standards and regulations for temporary electric service. Install service to comply with NFPA 70.



## TEMPORARY FACILITIES AND CONTROLS – SECTION 01 50 00

- B. Tests and Inspections: Arrange for authorities having jurisdiction to test and inspect each temporary utility before use. Obtain required certifications and permits.

### 1.7 PROJECT CONDITIONS

- A. Temporary Use of Permanent Facilities: Installer of each permanent service shall assume responsibility for operation, maintenance, and protection of each permanent service during its use as a construction facility before Owner's acceptance, regardless of previously assigned responsibilities.

## PART 2 - PRODUCTS

### 2.1 MATERIALS

- A. Chain-Link Fencing: Minimum 2-inch (50-mm), 0.148-inch- (3.76-mm-) thick, galvanized steel, chain-link fabric fencing; minimum 6 feet (1.8 m) high with galvanized steel pipe posts; minimum 2-3/8-inch- (60-mm-) OD line posts and 2-7/8-inch- (73-mm-) OD corner and pull posts, with 1-5/8-inch- (42-mm-) OD top rails.
- B. Portable Chain-Link Fencing: Minimum 2-inch (50-mm), 9-gage, galvanized steel, chain-link fabric fencing; minimum 6 feet (1.8 m) high with galvanized steel pipe posts; minimum 2-3/8-inch- (60-mm-) OD line posts and 2-7/8-inch- (73-mm-) OD corner and pull posts, with 1-5/8-inch- (42-mm-) OD top and bottom rails. Provide concrete bases for supporting posts.
- C. Lumber and Plywood: Comply with requirements in Division 6
- D. Gypsum Board: Minimum 1/2 inch (12.7 mm) thick by 48 inches (1219 mm) wide by maximum available lengths; regular-type panels with tapered edges. Comply with ASTM C 36/C 36M.

### 2.2 TEMPORARY FACILITIES

- ~~A. Field Offices, General: Prefabricated or mobile units with serviceable finishes, temperature controls, and foundations adequate for normal loading.~~
- ~~B. Common Use Field Office: Of sufficient size to accommodate needs of construction personnel. Keep office clean and orderly. Furnish and equip offices as follows:
  - 1. Furniture required for Project site documents including file cabinets, plan tables, plan racks, and bookcases.
  - 2. Conference room of sufficient size to accommodate meetings of 10 individuals. Provide electrical power service and 120 V ac duplex receptacles, with not less than 1 receptacle on each wall. Furnish room with conference table, chairs, and 4 foot (1.2 m) square tack board.
  - 3. Drinking water and private toilets.
  - 4. Coffee machine and supplies.
  - 5. Heating and cooling equipment necessary to maintain a uniform indoor temperature of 68 to 72 deg F (20 to 22 deg C).
  - 6. Lighting fixtures capable of maintaining average illumination of 20 fc (215 lx) at desk height.~~
- C. Storage and Fabrication Sheds: Provide sheds sized, furnished, and equipped to accommodate materials and equipment for construction operations.

## TEMPORARY FACILITIES AND CONTROLS – SECTION 01 50 00

1. Store combustible materials apart from building.

### 2.3 EQUIPMENT

- A. Fire Extinguishers: Portable, UL rated; with class and extinguishing agent as required by locations and classes of fire exposures.
- B. Heating Equipment: Unless Owner authorizes use of permanent heating system, provide vented, self-contained, liquid-propane-gas or fuel-oil heaters with individual space thermostatic control.
  1. Use of gasoline-burning space heaters, open-flame heaters, or salamander-type heating units is prohibited.
  2. Heating Units: Listed and labeled for type of fuel being consumed, by a testing agency acceptable to authorities having jurisdiction, and marked for intended use.

## PART 3 - EXECUTION

### 3.1 INSTALLATION, GENERAL

- A. Locate facilities where they will serve Project adequately and result in minimum interference with performance of the Work. Relocate and modify facilities as required by progress of the Work.
- B. Provide each facility ready for use when needed to avoid delay. Do not remove until facilities are no longer needed or are replaced by authorized use of completed permanent facilities.

### 3.2 TEMPORARY UTILITY INSTALLATION

- A. General: Install temporary service or connect to existing service.
  1. Arrange with utility company, Owner, and existing users for time when service can be interrupted, if necessary, to make connections for temporary services.
- B. Sewers and Drainage: Provide temporary utilities to remove effluent lawfully.
  1. Connect temporary sewers to municipal system as directed by authorities having jurisdiction.
- C. Water Service: Use of Owner's existing water service facilities will be permitted, as long as facilities are cleaned and maintained in a condition acceptable to Owner. At Substantial Completion, restore these facilities to condition existing before initial use.
- D. Sanitary Facilities: Provide temporary toilets, wash facilities, and drinking water for use of construction personnel. Comply with authorities having jurisdiction for type, number, location, operation, and maintenance of fixtures and facilities.
- E. Heating: Provide temporary heating required by construction activities for curing or drying of completed installations or for protecting installed construction from adverse effects of low temperatures or high humidity. Select equipment that will not have a harmful effect on completed installations or elements being installed.

## TEMPORARY FACILITIES AND CONTROLS – SECTION 01 50 00

- F. Ventilation and Humidity Control: Provide temporary ventilation required by construction activities for curing or drying of completed installations or for protecting installed construction from adverse effects of high humidity. Select equipment that will not have a harmful effect on completed installations or elements being installed. Coordinate ventilation requirements to produce ambient condition required and minimize energy consumption.
- G. Electric Power Service: Use of Owner's existing electric power service will be permitted, as long as equipment is maintained in a condition acceptable to Owner.
  - 1. Connect temporary service to Owner's existing power source, as directed by Owner.
- H. Lighting: Provide temporary lighting with local switching that provides adequate illumination for construction operations, observations, inspections, and traffic conditions.
  - 1. Install and operate temporary lighting that fulfills security and protection requirements without operating entire system.
  - 2. Install lighting for Project identification sign.
- I. Telephone Service: Provide temporary telephone service in common-use facilities for use by all construction personnel. Install two telephone line(s) for each field office.
  - 1. At each telephone, post a list of important telephone numbers.
    - a. Police and fire departments.
    - b. Ambulance service.
    - c. Contractor's home office.
    - d. Architect's office.
    - e. Engineers' offices.
    - f. Owner's office.
    - g. Principal subcontractors' field and home offices.
  - 2. Provide superintendent with cellular telephone or portable two-way radio for use when away from field office.

### 3.3 SUPPORT FACILITIES INSTALLATION

- A. General: Comply with the following:
  - 1. Provide incombustible construction for offices, shops, and sheds located within construction area or within 30 feet (9 m) of building lines. Comply with NFPA 241.
  - 2. Maintain support facilities until near Substantial Completion. Remove before Substantial Completion. Personnel remaining after Substantial Completion will be permitted to use permanent facilities, under conditions acceptable to Owner.
- B. Temporary Roads and Paved Areas: Construct and maintain temporary roads and paved areas adequate for construction operations. Locate temporary roads and paved areas as indicated on Drawings.
  - 1. Provide dust-control treatment that is nonpolluting and nontracking. Reapply treatment as required to minimize dust.
- C. Traffic Controls: Comply with requirements of authorities having jurisdiction.



## TEMPORARY FACILITIES AND CONTROLS – SECTION 01 50 00

1. Protect existing site improvements to remain including curbs, pavement, and utilities.
  2. Maintain access for fire-fighting equipment and access to fire hydrants.
- D. Parking: Arrange for temporary parking areas for construction personnel.
- E. Dewatering Facilities and Drains: Comply with requirements of authorities having jurisdiction. Maintain Project site, excavations, and construction free of water.
1. Dispose of rainwater in a lawful manner that will not result in flooding Project or adjoining properties nor endanger permanent Work or temporary facilities.
  2. Remove snow and ice as required to minimize accumulations.
- F. Project Identification and Temporary Signs: Provide Project identification and other signs as indicated on Drawings. Install signs where indicated to inform public and individuals seeking entrance to Project. Unauthorized signs are not permitted.
1. Provide temporary, directional signs for construction personnel and visitors.
  2. Maintain and touchup signs so they are legible at all times.
- G. Waste Disposal Facilities: Provide waste-collection containers in sizes adequate to handle waste from construction operations. Comply with requirements of authorities having jurisdiction. Comply with Division 1 Section 01 77 00 "Execution Requirements" for progress cleaning requirements.

### 3.4 SECURITY AND PROTECTION FACILITIES INSTALLATION

- A. Environmental Protection: Provide protection, operate temporary facilities, and conduct construction in ways and by methods that comply with environmental regulations and that minimize possible air, waterway, and subsoil contamination or pollution or other undesirable effects.
1. Comply with work restrictions specified in Division 1 Section 01 11 00 "Summary of Work."
- B. Temporary Erosion and Sedimentation Control: Comply with requirements specified in Division 2 Section "Site Clearing", and requirements of authority having jurisdiction.
- C. Stormwater Control: Comply with authorities having jurisdiction. Provide barriers in and around excavations and subgrade construction to prevent flooding by runoff of stormwater from heavy rains.
- D. Tree and Plant Protection: Comply with requirements specified in Division 2 Section "Tree Protection and Trimming."
- E. Tree and Plant Protection: Install temporary fencing located as indicated or outside the drip line of trees to protect vegetation from damage from construction operations. Protect tree root systems from damage, flooding, and erosion.
- F. Site Enclosure Fence: Before construction operations begin, furnish and install site enclosure fence in a manner that will prevent people and animals from easily entering site except by entrance gates.

## TEMPORARY FACILITIES AND CONTROLS – SECTION 01 50 00

1. Extent of Fence: As required to enclose entire Project site or portion determined sufficient to accommodate construction operations.
  2. Maintain security by limiting number of keys and restricting distribution to authorized personnel. Provide Owner with one set of keys.
- G. Security Enclosure and Lockup: Install substantial temporary enclosure around partially completed areas of construction. Provide lockable entrances to prevent unauthorized entrance, vandalism, theft, and similar violations of security.
- H. Barricades, Warning Signs, and Lights: Comply with requirements of authorities having jurisdiction for erecting structurally adequate barricades, including warning signs and lighting.
- I. Temporary Enclosures: Provide temporary enclosures for protection of construction, in progress and completed, from exposure, foul weather, other construction operations, and similar activities. Provide temporary weathertight enclosure for building exterior.
1. Where heating or cooling is needed and permanent enclosure is not complete, insulate temporary enclosures.
- J. Temporary Partitions: Provide floor-to-ceiling dustproof partitions to limit dust and dirt migration and to separate areas occupied by Owner from fumes and noise.
1. Construct dustproof partitions with gypsum wallboard with joints taped on occupied side, and fire-retardant plywood on construction operations side.
  2. Insulate partitions to provide noise protection to occupied areas.
  3. Seal joints and perimeter. Equip partitions with dustproof doors and security locks.
  4. Protect air-handling equipment.
  5. Weather strip openings.
  6. Provide walk-off mats at each entrance through temporary partition.
- K. Temporary Fire Protection: Install and maintain temporary fire-protection facilities of types needed to protect against reasonably predictable and controllable fire losses. Comply with NFPA 241.
1. Prohibit smoking in construction areas.
  2. Supervise welding operations, combustion-type temporary heating units, and similar sources of fire ignition according to requirements of authorities having jurisdiction.
  3. Develop and supervise an overall fire-prevention and -protection program for personnel at Project site. Review needs with local fire department and establish procedures to be followed. Instruct personnel in methods and procedures. Post warnings and information.
  4. Provide temporary standpipes and hoses for fire protection. Hang hoses with a warning sign stating that hoses are for fire-protection purposes only and are not to be removed. Match hose size with outlet size and equip with suitable nozzles.
- 3.5 OPERATION, TERMINATION, AND REMOVAL
- A. Supervision: Enforce strict discipline in use of temporary facilities. To minimize waste and abuse, limit availability of temporary facilities to essential and intended uses.
- B. Maintenance: Maintain facilities in good operating condition until removal.

**TEMPORARY FACILITIES AND CONTROLS – SECTION 01 50 00**

1. Maintain operation of temporary enclosures, heating, cooling, humidity control, ventilation, and similar facilities on a 24-hour basis where required to achieve indicated results and to avoid possibility of damage.
- C. Termination and Removal: Remove each temporary facility when need for its service has ended, when it has been replaced by authorized use of a permanent facility, or no later than Substantial Completion. Complete or, if necessary, restore permanent construction that may have been delayed because of interference with temporary facility. Repair damaged Work, clean exposed surfaces, and replace construction that cannot be satisfactorily repaired.

END OF SECTION 01 50 00



**SECTION 01 60 00**  
**PRODUCT REQUIREMENTS**

**PART 1 - GENERAL**

**1.1 RELATED DOCUMENTS**

- A. Drawings and general provisions of the Contract, including General and Supplementary Conditions and other Division 1 Specification Sections, apply to this Section.

**1.2 SUMMARY**

- A. This Section includes administrative and procedural requirements for selection of products for use in Project; product delivery, storage, and handling; manufacturers' standard warranties on products; special warranties; product substitutions; and comparable products.
- B. Related Sections include the following:
  - 1. Division 1 Section 01 77 00 "Closeout Procedures" for submitting warranties for Contract closeout.
  - 2. Divisions 2 through 49 Sections for specific requirements for warranties on products and installations specified to be warranted.

**1.3 DEFINITIONS**

- A. Products: Items purchased for incorporating into the Work, whether purchased for Project or taken from previously purchased stock. The term "product" includes the terms "material," "equipment," "system," and terms of similar intent.
- B. Substitutions: Changes in products, materials, equipment, and methods of construction from those required by the Contract Documents and proposed by Contractor.
- C. Basis-of-Design Product Specification: Where a specific manufacturer's product is named and accompanied by the words "basis of design," including make or model number or other designation, to establish the significant qualities related to type, function, dimension, in-service performance, physical properties, appearance, and other characteristics for purposes of evaluating comparable products of other named manufacturers.

**1.4 SUBMITTALS**

- A. Substitution Requests: Instructions to Bidders specify time restrictions for submitting requests for Substitutions during the bidding period, in compliance with this Section.
- B. After execution of Agreement, the Owner may, at the Owner's option, consider formal requests from the Contractor for substitution of products for those specified. One or more of the following conditions must be documented:
  - 1. Compliance with final interpretation of code requirements or insurance regulations which require that the use of a substituted Product.
  - 2. Unavailability of a specified Product through no fault of the Contractor.
  - 3. Inability of specified Product to perform properly of fit in designated place.

## PRODUCT REQUIREMENTS – SECTION 01 60 00

4. Manufacturer's or Fabricator's refusal or inability to certify or guarantee performance of a specified Product in the application intended.
- C. A Substitution Request constitutes a representation that the Bidder/Contractor:
1. Has investigated the proposed Product and determined that it meets or exceeds the quality level of the specified Product.
  2. Will provide the same warranty for the Substituted Product as for the specified Product.
  3. Will coordinate installation and make changes to the Work which may be required for the Work to be completed with no additional cost to the Owner.
  4. Waives claims for additional costs or time extension which may subsequently become apparent.
  5. Will reimburse the Owner for review or redesign services associated with re-approval by authorities.
- D. Substitutions will not be considered when they are indicated or implied on Shop Drawings or Product Data Submittals, without separate request on the form provided, or when acceptance will require revision to the Contract Documents.
- E. Submit three copies of each request for consideration. Limit each request to one proposed Substitution. Identify product or fabrication or installation method to be replaced. Include Specification Section number and title and Drawing numbers and titles.
1. Substitution Request Form: Use form provided at end of Section.
  2. Documentation: Show compliance with requirements for substitutions and the following, as applicable:
    - a. Statement indicating why specified material or product cannot be provided.
    - b. Coordination information, including a list of changes or modifications needed to other parts of the Work and to construction performed by Owner and separate contractors, that will be necessary to accommodate proposed substitution.
    - c. Detailed comparison of significant qualities of proposed substitution with those of the Work specified. Significant qualities may include attributes such as performance, weight, size, durability, visual effect, and specific features and requirements indicated.
    - d. Product Data, including drawings and descriptions of products and fabrication and installation procedures.
    - e. Provide MSDS information to confirm that the product is no more harmful than the products specified.
    - f. Samples, where applicable or requested.
    - g. List of similar installations for completed projects with project names and addresses and names and addresses of architects and owners.
    - h. Material test reports from a qualified testing agency indicating and interpreting test results for compliance with requirements indicated.
    - i. Research/evaluation reports evidencing compliance with building code in effect for Project, from a model code organization acceptable to authorities having jurisdiction.
    - j. Detailed comparison of Contractor's Construction Schedule using proposed substitution with products specified for the Work, including effect on the overall Contract Time. If specified product or method of construction cannot be provided within the Contract Time, include letter from manufacturer, on manufacturer's letterhead, stating lack of availability or delays in delivery.

## PRODUCT REQUIREMENTS – SECTION 01 60 00

- k. Cost information, including a proposal of change, if any, in the Contract Sum.
  - l. Contractor's certification that proposed substitution complies with requirements in the Contract Documents and is appropriate for applications indicated.
  - m. Contractor's waiver of rights to additional payment or time that may subsequently become necessary because of failure of proposed substitution to produce indicated results.
3. Architect's Action: If necessary, Architect will request additional information or documentation for evaluation within 7 days of receipt of a request for substitution. Architect will notify Contractor of acceptance or rejection of proposed substitution within 15 days of receipt of request, or 7 days of receipt of additional information or documentation, whichever is later.
- a. Form of Acceptance: Change Order.
  - b. Use product specified if Architect cannot make a decision on use of a proposed substitution within time allocated.

### 1.5 QUALITY ASSURANCE

- A. Compatibility of Options: If Contractor is given option of selecting between two or more products for use on Project, product selected shall be compatible with products previously selected, even if previously selected products were also options.

### 1.6 PRODUCT DELIVERY, STORAGE, AND HANDLING

- A. Deliver, store, and handle products using means and methods that will prevent damage, deterioration, and loss, including theft. Comply with manufacturer's written instructions.
- B. Delivery and Handling:
  - 1. Schedule delivery to minimize long-term storage at Project site and to prevent overcrowding of construction spaces.
  - 2. Coordinate delivery with installation time to ensure minimum holding time for items that are flammable, hazardous, easily damaged, or sensitive to deterioration, theft, and other losses.
  - 3. Deliver products to Project site in an undamaged condition in manufacturer's original sealed container or other packaging system, complete with labels and instructions for handling, storing, unpacking, protecting, and installing.
  - 4. Inspect products on delivery to ensure compliance with the Contract Documents and to ensure that products are undamaged and properly protected.
- C. Storage:
  - 1. Store products to allow for inspection and measurement of quantity or counting of units.
  - 2. Store materials in a manner that will not endanger Project structure.
  - 3. Store products that are subject to damage by the elements, under cover in a weathertight enclosure above ground, with ventilation adequate to prevent condensation.
  - 4. Store cementitious products and materials on elevated platforms.
  - 5. Store foam plastic from exposure to sunlight, except to extent necessary for period of installation and concealment.



## PRODUCT REQUIREMENTS – SECTION 01 60 00

6. Comply with product manufacturer's written instructions for temperature, humidity, ventilation, and weather-protection requirements for storage.
7. Protect stored products from damage and liquids from freezing.
8. Provide a secure location and enclosure at Project site for storage of materials and equipment by Owner's construction forces. Coordinate location with Owner.
9. Provide bonded and insured off-site storage and protection when site does not permit on-site storage and protection.

### 1.7 PRODUCT WARRANTIES

- A. Warranties specified in other Sections shall be in addition to, and run concurrent with, other warranties required by the Contract Documents. Manufacturer's disclaimers and limitations on product warranties do not relieve Contractor of obligations under requirements of the Contract Documents.
  1. Manufacturer's Warranty: Preprinted written warranty published by individual manufacturer for a particular product and specifically endorsed by manufacturer to Owner.
  2. Special Warranty: Written warranty required by or incorporated into the Contract Documents, either to extend time limit provided by manufacturer's warranty or to provide more rights for Owner.
- B. Submittal Time: Comply with requirements in Division 1 Section 01 77 00 "Closeout Procedures."

PART 2 - PRODUCTS (Not Used)

PART 3 – EXECUTION (Not Used)

**PRODUCT REQUIREMENTS – SECTION 01 60 00**

**SUBSTITUTION REQUEST FORM**

TO: Name of Architect  
Street Address  
City and State

**DEADLINE: Date**

PROJECT: Name of Project  
CIP # \_\_\_\_\_.\_\_\_\_.\_\_\_\_  
Eugene School District 4J

SPECIFIED ITEM: \_\_\_\_\_  
Section No. Paragraph Description

The Undersigned requests consideration of the following substitution:

\_\_\_\_\_

The Undersigned states that the following paragraphs are true, except where noted otherwise:

1. The function, appearance and quality of the proposed substitution are equivalent or superior to the specified item;
2. The proposed substitution does not affect dimensions shown on the Drawings;
3. The Undersigned will pay for changes to the building design, including engineering and design services, detailing and construction costs caused by the requested substitution;
4. The proposed substitution will have no adverse effect on other trades, the construction schedule, or specified warranty requirements;
5. Maintenance and service parts will be locally available for the proposed substitution;
6. The Undersigned has attached data concerning the proposed substitution, including: Manufacturers product description, specifications, drawings, photographs, performance and test data, adequate for evaluation of the request, with applicable portions of the data clearly indicated. Attachments also include description of changes to Contract Documents which the proposed substitution will require for its proper installation.

Submitted by: _____ Signature: _____ Firm: _____ Address: _____ Date: _____ Tel: _____ Fax: _____ Attachments: _____	For use by Architect: <input type="checkbox"/> Approved <input type="checkbox"/> Approved as noted. <input type="checkbox"/> Not Approved <input type="checkbox"/> Received too late By: _____ Date: _____ For use by 4J Project Manager: <input type="checkbox"/> Approved <input type="checkbox"/> Approved as noted. <input type="checkbox"/> Not Approved <input type="checkbox"/> Received too late By: _____ Date: _____
--	---

**END OF SECTION 01 60 00**

**SECTION 01 73 00**  
**EXECUTION REQUIREMENTS**

**PART 1 - GENERAL**

**1.1 RELATED DOCUMENTS**

- A. Drawings and general provisions of the Contract, including General and Supplementary Conditions and other Division 1 Specification Sections, apply to this Section.

**1.2 SUMMARY**

- A. This Section includes general procedural requirements governing execution of the Work including, but not limited to, the following:

- 1. Construction layout.
- 2. Field engineering and surveying.
- 3. General installation of products.
- 4. Coordination of Owner-installed products.
- 5. Progress cleaning.
- 6. Starting and adjusting.
- 7. Protection of installed construction.
- 8. Correction of the Work.

- B. Related Sections include the following:

- 1. Division 1 Section 01 31 00 "Project Management and Coordination" for procedures for coordinating field engineering with other construction activities.
- 2. Division 1 Section 01 33 00 "Submittal Procedures" for submitting surveys.
- 3. Division 1 Section 01 77 00 "Closeout Procedures" for submitting final property survey with Project Record Documents, recording of Owner-accepted deviations from indicated lines and levels, and final cleaning.

**1.3 SUBMITTALS**

- A. Landfill Receipts: Submit copy of receipts issued by a landfill facility, licensed to accept hazardous materials, for hazardous waste disposal.
- B. Final Property Survey: Submit 2 copies showing the Work performed and record survey data.

**1.4 QUALITY ASSURANCE**

- A. Land Surveyor Qualifications: A professional land surveyor who is legally qualified to practice in jurisdiction where Project is located and who is experienced in providing land-surveying services of the kind indicated.



PART 2 - PRODUCTS (Not Used)

PART 3 - EXECUTION

3.1 EXAMINATION

- A. Existing Conditions: The existence and location of site improvements, utilities, and other construction indicated as existing are not guaranteed. Before beginning work, investigate and verify the existence and location of mechanical and electrical systems and other construction affecting the Work.
  - 1. Before construction, verify the location and points of connection of utility services.
- B. Existing Utilities: The existence and location of underground and other utilities and construction indicated as existing are not guaranteed. Before beginning sitework, investigate and verify the existence and location of underground utilities and other construction affecting the Work.
  - 1. Before construction, verify the location and invert elevation at points of connection of sanitary sewer, storm sewer, and water-service piping; and underground electrical services.
  - 2. Furnish location data for work related to Project that must be performed by public utilities serving Project site.
- C. Acceptance of Conditions: Examine substrates, areas, and conditions, with Installer or Applicator present where indicated, for compliance with requirements for installation tolerances and other conditions affecting performance. Record observations.
  - 1. Written Report: Where a written report listing conditions detrimental to performance of the Work is required by other Sections, include the following:
    - a. Description of the Work.
    - b. List of detrimental conditions, including substrates.
    - c. List of unacceptable installation tolerances.
    - d. Recommended corrections.
  - 2. Verify compatibility with and suitability of substrates, including compatibility with existing finishes or primers.
  - 3. Examine roughing-in for mechanical and electrical systems to verify actual locations of connections before equipment and fixture installation.
  - 4. Examine walls, floors, and roofs for suitable conditions where products and systems are to be installed.
  - 5. Proceed with installation only after unsatisfactory conditions have been corrected.  
**PROCEEDING WITH THE WORK INDICATES ACCEPTANCE OF SURFACES AND CONDITIONS.**

3.2 PREPARATION

- A. Existing Utility Information: Furnish information to local utility that is necessary to adjust, move, or relocate existing utility structures, utility poles, lines, services, or other utility

## EXECUTION REQUIREMENTS – SECTION 01 73 00

appurtenances located in or affected by construction. Coordinate with authorities having jurisdiction.

- B. Field Measurements: Take field measurements as required to fit the Work properly. Recheck measurements before installing each product. Where portions of the Work are indicated to fit to other construction, verify dimensions of other construction by field measurements before fabrication. Coordinate fabrication schedule with construction progress to avoid delaying the Work.
- C. Space Requirements: Verify space requirements and dimensions of items shown diagrammatically on Drawings.
- D. Review of Contract Documents and Field Conditions: Immediately on discovery of the need for clarification of the Contract Documents, submit a request for information to Architect. Include a detailed description of problem encountered, together with recommendations for changing the Contract Documents.

### 3.3 CONSTRUCTION LAYOUT

- A. Verification: Before proceeding to lay out the Work, verify layout information shown on Drawings, in relation to the property survey and existing benchmarks. If discrepancies are discovered, notify Architect and Owner's Project Manager promptly.
  - 1. General: Engage a land surveyor to lay out the Work using accepted surveying practices.
- B. Site Improvements: Locate and lay out site improvements, including pavements, grading, fill and topsoil placement, utility slopes, and invert elevations.
- C. Building Lines and Levels: Locate and lay out control lines and levels for structures, building foundations, column grids, and floor levels, including those required for mechanical and electrical work. Transfer survey markings and elevations for use with control lines and levels. Level foundations and piers from two or more locations.
- D. Record Log: Maintain a log of layout control work. Record deviations from required lines and levels. Include beginning and ending dates and times of surveys, weather conditions, name and duty of each survey party member, and types of instruments and tapes used. Make the log available for reference by Architect and Owner's Project Manager.

### 3.4 FIELD ENGINEERING

- A. Identification: Owner will identify existing benchmarks, control points, and property corners.
- B. Reference Points: Locate existing permanent benchmarks, control points, and similar reference points before beginning the Work. Preserve and protect permanent benchmarks and control points during construction operations.
- C. Benchmarks: Establish and maintain a minimum of two permanent benchmarks on Project site, referenced to data established by survey control points. Comply with authorities having jurisdiction for type and size of benchmark.
  - 1. Record benchmark locations, with horizontal and vertical data, on Project Record Documents.

## EXECUTION REQUIREMENTS – SECTION 01 73 00

2. Where the actual location or elevation of layout points cannot be marked, provide temporary reference points sufficient to locate the Work.
3. Remove temporary reference points when no longer needed. Restore marked construction to its original condition.

### 3.5 INSTALLATION

- A. General: Locate the Work and components of the Work accurately, in correct alignment and elevation, as indicated.
  1. Make vertical work plumb and make horizontal work level.
  2. Where space is limited, install components to maximize space available for maintenance and ease of removal for replacement.
  3. Conceal pipes, ducts, and wiring in finished areas, unless otherwise indicated.
  4. Maintain minimum headroom clearance of seven feet in spaces without a suspended ceiling.
- B. Comply with manufacturer's written instructions and recommendations for installing products in applications indicated. Bring any conflicts to the Architect for review.
- C. Install products at the time and under conditions that will ensure the best possible results. Maintain conditions required for product performance until Substantial Completion.
- D. Conduct construction operations so no part of the Work is subjected to damaging operations or loading in excess of that expected during normal conditions of occupancy.
- E. Templates: Obtain and distribute to the parties involved templates for work specified to be factory prepared and field installed. Check Shop Drawings of other work to confirm that adequate provisions are made for locating and installing products to comply with indicated requirements.
- F. Anchors and Fasteners: Provide anchors and fasteners as required to anchor each component securely in place, accurately located and aligned with other portions of the Work.
  1. Mounting Heights: Where mounting heights are not indicated, mount components at heights directed by Architect.
  2. Allow for building movement, including thermal expansion and contraction.
  3. Coordinate installation of anchorages. Furnish setting drawings, templates, and directions for installing anchorages, including sleeves, concrete inserts, anchor bolts, and items with integral anchors, that are to be embedded in concrete or masonry. Deliver such items to Project site in time for installation.
- G. Joints: Make joints of uniform width. Where joint locations in exposed work are not indicated, arrange joints for the best visual effect. Fit exposed connections together to form hairline joints where possible. Obtain Architect and Owner's Project Manager approval for all questionable conditions.
- H. Hazardous Materials: Use products, cleaners, and installation materials that are not considered hazardous.

## EXECUTION REQUIREMENTS – SECTION 01 73 00

### 3.6 OWNER-INSTALLED PRODUCTS

- A. Site Access: Provide access to Project site for Owner's construction forces.
- B. Coordination: Coordinate construction and operations of the Work with work performed by Owner's construction forces.
  - 1. Construction Schedule: Inform Owner of Contractor's preferred construction schedule for Owner's portion of the Work. Adjust construction schedule based on a mutually agreeable timetable. Notify Owner if changes to schedule are required due to differences in actual construction progress.
  - 2. Preinstallation Conferences: Include Owner's construction forces at preinstallation conferences covering portions of the Work that are to receive Owner's work. Attend preinstallation conferences conducted by Owner's construction forces if portions of the Work depend on Owner's construction.

### 3.7 PROGRESS CLEANING

- A. General: Clean Project site and work areas daily, including common areas. Coordinate progress cleaning for joint-use areas where more than one installer has worked. Enforce requirements strictly. Dispose of materials lawfully.
  - 1. Comply with requirements in NFPA 241 for removal of combustible waste materials and debris.
  - 2. Do not hold materials more than 7 days during normal weather or 3 days if the temperature is expected to rise above 80 deg F (27 deg C).
  - 3. Containerize hazardous and unsanitary waste materials separately from other waste. Mark containers appropriately and dispose of legally, according to applicable regulations.
- B. Site: Maintain Project site free of waste materials and debris.
- C. Work Areas: Clean areas where work is in progress to the level of cleanliness necessary for safety and proper execution of the Work.
  - 1. Remove liquid spills promptly.
  - 2. Where dust would impair proper execution of the Work, broom-clean or vacuum the entire work area, as appropriate.
- D. Installed Work: Keep installed work clean. Clean installed surfaces according to written instructions of manufacturer or fabricator of product installed, using only cleaning materials specifically recommended. If specific cleaning materials are not recommended, use cleaning materials that are not hazardous to health or property and that will not damage exposed surfaces.
- E. Concealed Spaces: Remove debris from concealed spaces before enclosing the space.
- F. Exposed Surfaces in Finished Areas: Clean exposed surfaces and protect as necessary to ensure freedom from damage and deterioration at time of Substantial Completion.
- G. Waste Disposal: Burying or burning waste materials on-site will not be permitted. Washing waste materials down sewers or into waterways will not be permitted.



## EXECUTION REQUIREMENTS – SECTION 01 73 00

- H. During handling and installation, clean and protect construction in progress and adjoining materials already in place. Apply protective covering where required to ensure protection from damage or deterioration at Substantial Completion.
- I. Clean and provide maintenance on completed construction as frequently as necessary through the remainder of the construction period. Adjust and lubricate operable components to ensure operability without damaging effects.
- J. Limiting Exposures: Supervise construction operations to assure that no part of the construction, completed or in progress, is subject to harmful, dangerous, damaging, or otherwise deleterious exposure during the construction period.

### 3.8 STARTING AND ADJUSTING

- A. Start equipment and operating components to confirm proper operation. Remove malfunctioning units, replace with new units, and retest.
- B. Adjust operating components for proper operation without binding. Adjust equipment for proper operation.
- C. Test each piece of equipment to verify proper operation. Test and adjust controls and safeties. Replace damaged and malfunctioning controls and equipment.
- D. Manufacturer's Field Service: If a factory-authorized service representative is required to inspect field-assembled components and equipment installation, comply with qualification requirements in Division 1 Section 01 40 00 "Quality Requirements."

### 3.9 PROTECTION OF INSTALLED CONSTRUCTION

- A. Provide final protection and maintain conditions that ensure installed Work is without damage or deterioration at time of Substantial Completion.
- B. Comply with manufacturer's written instructions for temperature and relative humidity.

### 3.10 CORRECTION OF THE WORK

- A. Repair or remove and replace defective construction. Restore damaged substrates and finishes.
  - 1. Repairing includes replacing defective parts, refinishing damaged surfaces, touching up with matching materials, and properly adjusting operating equipment.
- B. Restore permanent facilities used during construction to their specified condition.
- C. Remove and replace damaged surfaces that are exposed to view if surfaces cannot be repaired without visible evidence of repair.
- D. Repair components that do not operate properly. Remove and replace operating components that cannot be repaired.
- E. Remove and replace chipped, scratched, and broken glass or reflective surfaces.

**EXECUTION REQUIREMENTS – SECTION 01 73 00**

END OF SECTION 01 73 00

**CUTTING AND PATCHING**  
**SECTION 01 73 29**

**PART 1 - GENERAL**

**1.1 RELATED DOCUMENTS**

- A. Drawings and general provisions of the Contract, including General and Supplementary Conditions and other Division 1 Specification Sections, apply to this Section.

**1.2 SUMMARY**

- A. This Section includes procedural requirements for cutting and patching.
- B. Related Sections include the following:
  - 1. Division 1 Section 10 31 00 – “Project Management and Coordination” for pre-construction and pre-installation conferences.
  - 2. Division 2 Section "Selective Demolition" for demolition of selected portions of the building.
  - 3. Divisions 2 through 49 Sections for specific requirements and limitations applicable to cutting and patching individual parts of the Work.

**1.3 DEFINITIONS**

- A. Cutting: Removal of in-place construction necessary to permit installation or performance of other Work.
- B. Patching: Fitting and repair work required to restore surfaces to original conditions after installation of other Work.

**1.4 SUBMITTALS**

- A. Cutting and Patching Proposal: Submit a written request describing procedures prior to the time cutting and patching will be performed, requesting approval to proceed, for cutting or alteration which affects:
  - 1. Structural integrity of any element of Project.
  - 2. Integrity of weather-exposed or moisture-resistant element.
  - 3. Efficiency, maintenance, or safety of any operational element.
  - 4. Visual qualities of site-exposed elements.
  - 5. Work of Owner or separate contractor.
- B. Include the following information:
  - 1. Identification of Project and CIP number
  - 2. Location and description of the affected Work.
  - 3. Necessity for cutting or alteration.
  - 4. Description of proposed Work and Products to be used.
  - 5. Alternatives to cutting and patching.
  - 6. Effect on work of Owner or separate contractor.
  - 7. Written permission of affected separate contractor, if any.

8. date and time work will be executed.

#### 1.5 QUALITY ASSURANCE

- A. Structural Elements: Do not cut and patch structural elements in a manner that could change their load-carrying capacity or load-deflection ratio.
  1. Operational Elements: Do not cut and patch operating elements and related components in a manner that results in reducing their capacity to perform as intended or that results in increased maintenance or decreased operational life or safety.
  2. Miscellaneous Elements: Do not cut and patch miscellaneous elements or related components in a manner that could change their load-carrying capacity, that results in reducing their capacity to perform as intended, or that results in increased maintenance or decreased operational life or safety.
- B. Visual Requirements: Do not cut and patch construction in a manner that results in visual evidence of cutting and patching. Do not cut and patch construction exposed on the exterior or in occupied spaces in a manner that would, in Architect's opinion, reduce the building's aesthetic qualities. Remove and replace construction that has been cut and patched in a visually unsatisfactory manner.

#### 1.6 WARRANTY

- A. Existing Warranties: Remove, replace, patch, and repair materials and surfaces cut or damaged during cutting and patching operations, by methods and with materials so as not to void existing warranties.

### PART 2 - PRODUCTS

#### 2.1 MATERIALS

- A. General: Comply with requirements specified in other Sections.
- B. In-Place Materials: Use materials identical to in-place materials. For exposed surfaces, use materials that visually match in-place adjacent surfaces to the fullest extent possible.
  1. If identical materials are unavailable or cannot be used, use materials that, when installed, will match the visual and functional performance of in-place materials.

### PART 3 - EXECUTION

#### 3.1 EXAMINATION

- A. Examine surfaces to be cut and patched and conditions under which cutting and patching are to be performed.
  1. Compatibility: Before patching, verify compatibility with and suitability of substrates, including compatibility with in-place finishes or primers.
  2. Proceed with installation only after unsafe or unsatisfactory conditions have been corrected.



3.2 PREPARATION

- A. Temporary Support: Provide temporary support of Work to be cut.
- B. Protection: Protect in-place construction during cutting and patching to prevent damage. Provide protection from adverse weather conditions for portions of Project that might be exposed during cutting and patching operations.
- C. Adjoining Areas: Avoid interference with use of adjoining areas or interruption of free passage to adjoining areas.
- D. Existing Utility Services and Mechanical/Electrical Systems: Where existing services/systems are required to be removed, relocated, or abandoned, bypass such services/systems before cutting to minimize interruption to occupied areas.

3.3 PERFORMANCE

- A. General: Employ skilled workers to perform cutting and patching. Proceed with cutting and patching at the earliest feasible time, and complete without delay.
  - 1. Cut in-place construction to provide for installation of other components or performance of other construction, and subsequently patch as required to restore surfaces to their original condition.
- B. Cutting: Cut in-place construction by sawing, drilling, breaking, chipping, grinding, and similar operations, including excavation, using methods least likely to damage elements retained or adjoining construction. If possible, review proposed procedures with original Installer; comply with original Installer's written recommendations.
  - 1. In general, use hand or small power tools designed for sawing and grinding, not hammering and chopping. Cut holes and slots as small as possible, neatly to size required, and with minimum disturbance of adjacent surfaces. Temporarily cover openings when not in use.
  - 2. Finished Surfaces: Cut or drill from the exposed or finished side into concealed surfaces.
  - 3. Concrete or Masonry: Cut using a cutting machine, such as an abrasive saw or a diamond-core drill.
  - 4. Excavating and Backfilling: Comply with requirements in applicable Division 2 Sections where required by cutting and patching operations.
  - 5. Mechanical and Electrical Services: Cut off pipe or conduit in walls or partitions to be removed. Cap, valve, or plug and seal remaining portion of pipe or conduit to prevent entrance of moisture or other foreign matter after cutting.
  - 6. Proceed with patching after construction operations requiring cutting are complete.
- C. Patching: Patch construction by filling, repairing, refinishing, closing up, and similar operations following performance of other Work. Patch with durable seams that are as invisible as possible. Provide materials and comply with installation requirements specified in other Sections.
  - 1. Inspection: Where feasible, test and inspect patched areas after completion to demonstrate integrity of installation.

## CUTTING AND PATCHING - SECTION 01 73 29

2. Exposed Finishes: Restore exposed finishes of patched areas and extend finish restoration into retained adjoining construction in a manner that will eliminate evidence of patching and refinishing.
    - a. Clean piping, conduit, and similar features before applying paint or other finishing materials.
    - b. Restore damaged pipe covering to its original condition.
  3. Floors and Walls: Where walls or partitions that are removed extend one finished area into another, patch and repair floor and wall surfaces in the new space. Provide an even surface of uniform finish, color, texture, and appearance. Remove in-place floor and wall coverings and replace with new materials, if necessary, to achieve uniform color and appearance.
    - a. Where patching occurs in a painted surface, apply primer and intermediate paint coats over the patch and apply final paint coat over entire unbroken surface containing the patch. Provide additional coats until patch blends with adjacent surfaces.
  4. Ceilings: Patch, repair, or rehang in-place ceilings as necessary to provide an even-plane surface of uniform appearance.
  5. Exterior Building Enclosure: Patch components in a manner that restores enclosure to a weathertight condition.
- D. Cleaning: Clean areas and spaces where cutting and patching are performed. Completely remove paint, mortar, oils, putty, and similar materials.

END OF SECTION 01 73 29

**SECTION 01 77 00**  
**CLOSEOUT PROCEDURES**

**PART 1 - GENERAL**

**1.1 RELATED DOCUMENTS**

- A. Drawings and general provisions of the Contract, including General and Supplementary Conditions and other Division 1 Specification Sections, apply to this Section.

**1.2 SUMMARY**

- A. This Section includes administrative and procedural requirements for contract closeout, including, but not limited to, the following:

1. Inspection procedures.
2. Warranties.
3. Final cleaning.

- B. Related Sections include the following:

1. Division 1 Section 01 29 00 "Payment Procedures" for requirements for Applications for Payment for Substantial and Final Completion.
2. Division 1 Section 01 73 00 "Execution Requirements" for progress cleaning of Project site.
3. Division 1 Section 01 78 23 "Operation and Maintenance Data" for operation and maintenance manual requirements.
4. Division 1 Section 01 78 39 "Project Record Documents" for submitting Record Drawings, Record Specifications, and Record Product Data.
5. Divisions 2 through 49 Sections for specific closeout and special cleaning requirements for the Work in those Sections.

**1.3 SUBSTANTIAL COMPLETION**

- A. Preliminary Procedures: Before requesting inspection for determining date of Substantial Completion, complete the following. List items below that are incomplete in request.

1. Prepare a list of items to be completed and corrected (punch list), the value of items on the list, and reasons why the Work is not complete.
2. Advise Owner of pending insurance changeover requirements.
3. Submit specific warranties, workmanship bonds, maintenance service agreements, final certifications, and similar documents.
4. Obtain and submit releases permitting Owner unrestricted use of the Work and access to services and utilities. Include occupancy permits, operating certificates, and similar releases.
5. Prepare and submit Project Record Documents, operation and maintenance manuals, damage or settlement surveys, property surveys, and similar final record information.
6. Deliver tools, spare parts, extra materials, and similar items to location designated by Owner. Label with manufacturer's name and model number where applicable.

## CLOSEOUT PROCEDURES - SECTION 01 77 00

7. Make final changeover of permanent locks and deliver keys to Owner. Advise Owner's personnel of changeover in security provisions.
8. Complete startup testing of systems.
9. Submit test/adjust/balance records.
10. Terminate and remove temporary facilities from Project site, along with mockups, construction tools, and similar elements.
11. Advise Owner of changeover in heat and other utilities.
12. Submit changeover information related to Owner's occupancy, use, operation, and maintenance.
13. Complete final cleaning requirements, including touchup painting.
14. Touch up and otherwise repair and restore marred exposed finishes to eliminate visual defects.

B. Inspection: Submit a written request for inspection for Substantial Completion. On receipt of request, Architect and Owner's Project Manager will either proceed with inspection or notify Contractor of unfulfilled requirements. Architect will prepare the Certificate of Substantial Completion after inspection or will notify Contractor of items, either on Contractor's list or additional items identified by Architect, that must be completed or corrected before certificate will be issued.

1. Reinspection: Request reinspection when the Work identified in previous inspections as incomplete is completed or corrected.
2. Results of completed inspection will form the basis of requirements for Final Completion.

### 1.4 FINAL COMPLETION

A. Preliminary Procedures: Before requesting final inspection for determining date of Final Completion, complete the following:

1. Submit a final Application for Payment according to Division 1 Section "Payment Procedures."
2. Submit certified copy of Architect's Substantial Completion inspection list of items to be completed or corrected (punch list), endorsed and dated by Architect. The certified copy of the list shall state that each item has been completed or otherwise resolved for acceptance.
3. Submit evidence of final, continuing insurance coverage complying with insurance requirements.
4. Submit the following completed forms, items and documents:
  - a. AIA Document G706 Contractor's Affidavit of Payment of Debts and Claims.
  - b. AIA Document G706A Contractor's Affidavit of Release of Liens.
  - c. AIA Document G707 Consent of Surety Company to Final Payment.
  - d. Operation and Maintenance Manuals
  - e. Warranties and Bonds. Submit original documents, including Contractor's General Warranty,
  - f. Record Documents.
  - g. Summary of Abatement Activities with Submittals.
  - h. Amended LRAPA Notifications.
  - i. Asbestos Waste Shipment Records.
  - j. Worker Certifications for all workers on the Project.
  - k. Air Monitoring Data.



- l. Keys.
  - m. Testing and Start-Up records.
  - n. Affidavit of Prevailing Wages paid.
  - o. Complete list of Contractor and all Subcontractors with address, phone numbers, and work
  - p. Asbestos-Containing Materials Statement (Form 01100B).
  - q. Proof of final acceptance and compliance from governing authorities having jurisdiction.
  - r. Certificate of insurance evidencing continuation of liability coverage including coverage for completed operations until the expiration of the specified warranty periods.
5. Instruct Owner's personnel in operation, adjustment, and maintenance of products, equipment, and systems.
- B. Inspection: Submit a written request for final inspection for acceptance. On receipt of request, Architect and Owner's Project Manager will either proceed with inspection or notify Contractor of unfulfilled requirements. Architect will prepare a final Certificate for Payment after inspection or will notify Contractor of construction that must be completed or corrected before certificate will be issued.
1. Reinspection: Request reinspection when the Work identified in previous inspections as incomplete is completed or corrected.
  2. Cost of additional re-inspections by Architect and Owner's Project manager will be deducted from Final Payment to the Contractor.

#### 1.5 WARRANTIES

- A. Submittal Time: Submit written warranties on request of Architect for designated portions of the Work where commencement of warranties other than date of Substantial Completion is indicated.
- B. Partial Occupancy: Submit properly executed warranties within 10 days of completion of designated portions of the Work that are completed and occupied or used by Owner during construction period by separate agreement with Contractor.
- C. Organize warranty documents into an orderly sequence based on the table of contents of the Project Manual.
1. Bind warranties and bonds in heavy-duty, 3-ring, vinyl-covered, loose-leaf binders, thickness as necessary to accommodate contents, and sized to receive 8-1/2-by-11-inch (215-by-280-mm) paper.
  2. Provide heavy paper dividers with plastic-covered tabs for each separate warranty. Mark tab to identify the product or installation. Provide a typed description of the product or installation, including the name of the product and the name, address, and telephone number of Installer.
  3. Identify each binder on the front and spine with the typed or printed title "WARRANTIES," Project name, and name of Contractor.
- D. Provide additional copies of each warranty to include in operation and maintenance manuals.

**PART 2 - PRODUCTS**

**MATERIALS**

- A. Cleaning Agents: Use cleaning materials and agents recommended by manufacturer or fabricator of the surface to be cleaned. Do not use cleaning agents that are potentially hazardous to health or property or that might damage finished surfaces.

**PART 3 - EXECUTION**

**3.1 FINAL CLEANING**

- A. General: Provide final cleaning. Conduct cleaning and waste-removal operations to comply with local laws and ordinances and Federal and local environmental and antipollution regulations.
- B. Cleaning: Employ experienced workers or professional cleaners for final cleaning. Clean each surface or unit to condition expected in an average commercial building cleaning and maintenance program. Comply with manufacturer's written instructions.
  - 1. Complete the following cleaning operations before requesting inspection for certification of Substantial Completion for entire Project or for a portion of Project:
    - a. Clean Project site, yard, and grounds, in areas disturbed by construction activities, including landscape development areas, of rubbish, waste material, litter, and other foreign substances.
    - b. Sweep paved areas broom clean. Remove petrochemical spills, stains, and other foreign deposits.
    - c. Rake grounds that are neither planted nor paved to a smooth, even-textured surface.
    - d. Remove tools, construction equipment, machinery, and surplus material from Project site.
    - e. Remove snow and ice to provide safe access to building.
    - f. Clean exposed exterior and interior hard-surfaced finishes to a dirt-free condition, free of stains, films, and similar foreign substances. Avoid disturbing natural weathering of exterior surfaces. Restore reflective surfaces to their original condition.
    - g. Remove debris and surface dust from limited access spaces, including roofs, plenums, shafts, trenches, equipment vaults, manholes, attics, and similar spaces.
    - h. Sweep concrete floors broom clean in unoccupied spaces.
    - i. Vacuum carpet and similar soft surfaces, removing debris and excess nap; shampoo if visible soil or stains remain.
    - j. Clean transparent materials, including mirrors and glass in doors and windows. Remove glazing compounds and other noticeable, vision-obscuring materials. Replace chipped or broken glass and other damaged transparent materials. Polish mirrors and glass, taking care not to scratch surfaces.
    - k. Remove labels that are not permanent.
    - l. Touch up and otherwise repair and restore marred, exposed finishes and surfaces. Replace finishes and surfaces that cannot be satisfactorily repaired or restored or that already show evidence of repair or restoration.

## CLOSEOUT PROCEDURES - SECTION 01 77 00

- 1) Do not paint over "UL" and similar labels, including mechanical and electrical nameplates.
  - m. Wipe surfaces of mechanical and electrical equipment, and similar equipment. Remove excess lubrication, paint and mortar droppings, and other foreign substances.
  - n. Replace parts subject to unusual operating conditions.
  - o. Clean plumbing fixtures to a sanitary condition, free of stains, including stains resulting from water exposure.
  - p. Replace disposable air filters and clean permanent air filters. Clean exposed surfaces of diffusers, registers, and grills.
  - q. Clean ducts, blowers, and coils if units were operated without filters during construction.
  - r. Clean light fixtures, lamps, globes, and reflectors to function with full efficiency. Replace burned-out bulbs, and those noticeably dimmed by hours of use, and defective and noisy starters in fluorescent and mercury vapor fixtures to comply with requirements for new fixtures.
  - s. Leave Project clean and ready for occupancy.
- C. Comply with safety standards for cleaning. Do not burn waste materials. Do not bury debris or excess materials on Owner's property. Do not discharge volatile, harmful, or dangerous materials into drainage systems. Remove waste materials from Project site and dispose of lawfully.

END OF SECTION 01 77 00

**SECTION 02 20 80**  
**ASBESTOS ABATEMENT PROCEDURES**

**PART 1 - GENERAL**

**1.01 SCOPE:**

- A. This Section covers the removal, patching and/or encapsulation of materials that contain, or are suspected to contain asbestos.
- B. See other Sections of these Specifications and EPA, OSHA, and other standards referenced herein, for further information and requirements.

**1.02 DEFINITIONS:**

- A. Abatement: Procedures to control fiber release from asbestos-containing building materials. Includes encapsulation, enclosure, removal, repair and related activities.
- B. Air Monitoring: Process of measuring the asbestos fiber content of a specific volume of air in a stated period of time.
- C. Air Monitoring Technician: An employee of the independent testing laboratory who is experienced and trained in asbestos sampling and analysis as specified.
- D. Amended Water: Water to which a surfactant (wetting agent) has been added.
- E. Authorized Visitor: The District or its designated representative, or a representative of any regulatory or other agency having jurisdiction over the Project.
- F. Clean Room: Uncontaminated area or room which is part of the worker decontamination enclosure system, with provisions for storage of workers' street clothes and clean protective equipment.
- G. Curtained Doorway: A device to allow ingress or egress from one room to another while permitting minimal air movement between the rooms.
- H. Disposal: Procedures necessary to transport and deposit the asbestos contaminated material in an approved waste disposal site in compliance with EPA and other applicable regulations.
- I. Enclosures: Procedures necessary to complete enclosure of all asbestos containing material behind airtight, impermeable, permanent barriers.
- J. Equipment Room: Contaminated area or room which is part of the worker decontamination enclosure system, with provisions for storage of contaminated clothing and equipment.
- K. Fitting: With regard to pipe insulation, fitting is defined to be any elbow, offset, reducer, valve, union, tee, thermometer, etc., insulated with a different material from the adjacent straight run of pipe.
- L. HEPA Filter: High Efficiency Particulate Air (HEPA) filter capable of trapping and retaining 99.97% of asbestos fibers greater than 0.3 microns in length.



- M. HEPA Vacuum Equipment: High efficiency particulate air (HEPA) filtered vacuuming equipment with a filter system capable of collecting and retaining asbestos fibers. Filters shall be of 99.97% efficiency for retaining fibers of 0.3 microns or larger.
- N. Independent Testing Laboratory: An independent laboratory hired by the Contractor which is AIHA accredited for asbestos analysis and has demonstrated proficiency via the NIOSH PAT and EPA QA programs.
- O. Isolated Work Area: Isolated area of the facility where abatement activities are performed.
- P. Air Filtration Machine: An air purifying fan system located within, or outside, the isolated work area, which draws air out of the work area through a HEPA filter, thus keeping the static air pressure in the work area lower than in adjacent areas and preventing infiltration of contaminated air from work area to adjacent areas.
- Q. Public Area: Any area outside the isolated work area. When work area isolation measures are removed, the work area becomes a public area.
- R. Shower Room: A room between the clean room and the equipment room in the worker decontamination enclosure system, with hot and cold running water controllable at the faucet, equipped with water filtration as specified below, and suitably arranged for complete showering during decontamination. The shower room must be separated from the clean room and equipment room by curtained door ways.
- S. Surfactant: A chemical wetting agent added to water to improve penetration, thus reducing the quantity of water required for a given operation or area.
- T. Tack Coat: A coat of penetrating encapsulant applied to all surfaces from which asbestos-containing materials have been removed.
- U. Vacuum Tract Removal: Wetting and pneumatic conveying of loose material through a vacuum hose to a sealed, truck-mounted collection tank specially equipped to prevent escape of fibers.
- V. Wet Cleaning: Process of eliminating asbestos from building surfaces and objects by using cloths, mops, or other cleaning tools which have been dampened with water.
- W. Worker Decontamination Enclosure System: A decontamination enclosure system for workers, typically consisting of a clean room, a shower room, and an equipment room. Each of these rooms is separated from the others by a curtain doorway. The equipment room is separated from the work area by a curtained doorway. The clean room is separated from the public area by a curtained doorway.
- X. Worksite Entry Log: A log kept in the clean room must be signed by everyone entering or leaving the work area.
- Y. Full Scale Supervisor: Per CFR Title 29, Section 1926.58, an employee of the Contractor trained in all aspects of asbestos abatement, whose duties include supervision of the enclosure, entry to and exit from the enclosure, employee exposure monitoring, engineering controls, and employee work practices, respirators, protective equipment, decontamination and hygiene practices.

### 1.03 DOCUMENTS INCORPORATED BY REFERENCE:

- A. The current issue of each document shall govern. Where conflict among requirements, or with these Specifications, exists the more stringent requirements shall apply.
1. U.S. Environmental Protection Agency National Emissions Standards for Hazardous Air Pollutants (NESHAPS). (Code of Federal Regulations Title 40, Part 61, Subparts A and B.)
  2. U.S. Environmental Protection Agency Office of Toxic Substances Guidance Document, "Guidance for Controlling Asbestos-Containing Materials in Buildings" EPA Report Number 560/5-85-024 ("Purple Book").
  3. U.S. Environmental Protection Agency Asbestos Abatement Project. E.P.A. 40 C.F.R Part 763 - Subpart G.
  4. U.S. Environmental Protection Agency Asbestos Containing Materials In Schools Project. E.P.A. 40 C.F.R Part 763 - Subpart E.
  5. U.S. Department of Labor Occupational Safety and Health Administration (OSHA):
    - a. Title 29 Code of Federal Regulations Section 1910.1001, General Industry Standard for Asbestos
    - b. Title 29 Code of Federal Regulations Section 1910.134, General Industry Standard for Respiratory Protection.
    - c. Title 29 Code of Federal Regulations Sections 1926.1101, Asbestos
    - d. Title 29 Code of Federal Regulations Section 1910.2, Access to Employee Exposure and Medical Records.
    - e. Title 29 Code of Federal Regulations Section 1910.1200, Hazard Communication.
  6. National Institute for Occupational Safety and Health (NIOSH), 30 CFR, Part II, Respirators.
  7. American National Standards Institute (ANSI) NY; ANSI Standard z 88.2-1980 "American National Standards Practice for Respiratory Protection," latest edition.
  8. Oregon Administrative Rules Chapter 340, Division 25 Department of Environmental Quality.
  9. Oregon Administrative Rules Chapter 437, Division 115, Asbestos and Division 22.
  10. Uniform Building Code (U.B.C.), latest edition, regulations as applicable.
  11. All related electrical work shall be performed in accordance with the National Electric Code.
  12. All Lane Regional Air Pollution Authorities regulations and rules pertaining to asbestos, including its storage, transportation, and disposal.

### 1.04 NOTICES

- A. Not less than ten (10) days before commencing work on each Project, notify the Lane Regional Air Pollution Authority (LRAPA) with copies to the District.

#### 1.05 SUBMITTALS

- A. Submittals are specific in Section 01330. Do not begin work until submittals are complete and pre-abatement air sampling is complete.

#### 1.06 PERSONNEL PROTECTION

##### A. Training

1. Prior to commencement of Work, all workers shall be trained as specified in Section 01330, Para. 1.3, B & C.
2. The Contractor shall provide and post in the clean room(s) and the equipment room(s), the decontamination, respirator, and work procedures to be followed by the workers.

##### B. Personnel Protective Equipment for Asbestos Removal in Isolated Work Areas:

1. Work Clothes shall consist of disposable full body coveralls and head and foot covers ("Tyvek" or approved), boots. Eye, hearing, fall protection and hard hats should be available as appropriate.
2. At a minimum, respiratory protection shall consist of disposable cartridge type NIOSH/OSHA approved, full- face-mask, powered air-purifying positive pressure respirators equipped with HEPA filter cartridges (magenta/purple color code). Additional respiratory protection shall be as required by OSHA, and Oregon Occupational Safety and Health Code, OAR Chapter 437, Division 115, Asbestos. No negative pressure respirators will be allowed without District approval.
3. As part of the Contractor's Respiratory Protection Program, all workers shall be provided with a selection of brands and sizes of respirators to choose from. At a minimum, all workers shall be qualitatively fit tested at the time of respirator selection per Oregon OSHA Workers' Compensation Department Rule 22-069 (4) (e) (5) (i) and prior to each day's work.
4. Replacement filter cartridges shall be supplied as required. Cartridges which have become wet or clogged shall be replaced immediately.

##### C. Worker Decontamination Enclosure System at Isolated Work Areas:

1. The Contractor shall construct a personnel decontamination facility attached to the isolated work area consisting of three chambers and curtained doorways as follows:
  - a. The equipment room shall have a curtained doorway to the work area and to the shower area.
  - b. The shower room shall have two curtained doorways, onto the equipment room and one to the clean room. At least one shower with hot and cold water controllable at the taps shall be installed in this room. The Contractor shall supply and maintain soap, shampoo, and towels at all times in the shower area. Shower waste water shall be filtered promptly to remove all fibers larger than five microns before disposal in the municipal sewer system, or shall be

collected and disposed of as asbestos-contaminated material. Water filters shall be disposed of as asbestos-contaminated material. The Contractor shall not allow waste water to accumulate in the shower room.

- c. The clean room shall consist of a curtained doorway to the shower room and a curtained doorway to the outside. The clean room shall contain a first aid kit, storage for workers and visitors' clothing and shoes, a place to sit down, and the worksite entry logbook. Work, respirator and decontamination procedures and prevailing wage rates shall be conspicuously posted. There shall be a supply of clean protective clothing, respirators and cartridges in the clean room at all times

2. No asbestos abatement work shall occur unless this system is functional, and in good repair.

D. Worker Protection Procedures in Isolated Work Areas:

1. Each worker shall, upon entering the Job Site; remove street clothes in the clean change room, put on and fit test his respirator, put on clean protective clothing and sign in on the worksite entry logbook before entering the equipment room or the work area.
2. Workers shall, each time they leave the work area: remove gross contamination from clothing before leaving the work area; proceed to the equipment room and remove and store boots and other equipment except respirators; still wearing the respirator proceed naked to the showers; clean the outside of the respirator; tape filter openings, thoroughly shampoo and wash themselves; remove filters, dispose of filters if wet in the container provided for the purpose; and wash and rinse the inside of the respirator.
3. Following showering and drying off, each worker shall proceed directly to the clean change room and dress in clean clothes and sign out on the worksite entry logbook at the end of each day's work, or before eating, smoking, or drinking. Before re-entering the work area from the clean change room, each worker shall put on his respirator, dress in clean protective clothing, and sign in on the worksite entry logbook.
4. Contaminated work footwear and other equipment shall be stored in the equipment room when not in use in the work area. Upon completion of asbestos abatement, dispose of footwear as contaminated waste or clean thoroughly inside and out using soap and water before removing from work area.
5. Workers shall not eat, drink or chew gum or tobacco at the worksite except in the established clean room. Smoking is prohibited.
6. Workers shall be fully protected with respirators and protective clothing immediately prior to the first disturbance of asbestos containing or contaminated material and until final clean-up is completed.

E. Access to Isolated Work Area by Others:

1. Except for emergency personnel, limit access to the work area to authorized visitors.
2. Provide dress and equipment for all authorized visitors, as specified above, up to a maximum of 4 visitors per 24-hour day.
3. All authorized visitors shall be subject to the personal protection provisions specified above, and shall



sign in and out on the worksite entry logbook.

F. Emergency Precautions:

1. Establish emergency and fire exits from the work area.
2. Be prepared to administer first aid to injured personnel after decontamination. Seriously injured personnel shall be treated immediately or evacuated without delay for decontamination
3. Notify the local fire department if any fire exits are to be blocked or if sprinkler or fire alarm systems are to be turned off.

G. Building Security and Protection:

1. Post adequate warning signs at designated entrances to work areas as required by EPA and OSHA.
2. Protect all existing fixed equipment, existing building finishes that are to remain, and existing systems and functions from damage during the abatement process. Extra functions from damage during the abatement process. Extra precautions shall be taken in protecting existing electrical panels, light fixtures, etc. Any damage to existing building, services, and/or equipment shall be remedied at the Contractor's expense.
3. Maintain access and use of existing fire lanes

1.07 Safety

- A. With regard to the Work of this Contract, the safety of the Contractor's employees, the District's employees, and the public is the sole responsibility of the Contractor.

1.08 Delivery

- A. Deliver all materials in the original packages, containers or bundles bearing the name of the manufacturer and the brand name.

1.09 Storage

- A. Store all materials subject to damage off the ground, away from wet or damp surfaces, and under cover sufficient to prevent damage or contamination.

1.10 Protection

- A. Damaged or deteriorating materials shall not be used and shall be removed from the premises. Materials that become contaminated with asbestos shall be disposed of in accordance with the applicable regulations.

PART 2 - PRODUCTS:

2.01 MATERIALS

- A. Plastic Sheet: Plastic sheet polyethylene material sized in lengths and widths to minimize the frequency of joints. The minimum thickness shall be as follows:

Application	Thickness
Door, Window & Opening Barriers	6 mil
Wall Barriers	2 layers of 4 mil
Floor Barriers	2 layers of 6 mil
All Others	2 layers of 4 mil

- B. Plastic Bags: Plastic bags shall be 6 mil polyethylene with warning labels per OSHA and EPA regulations.
- C. Tape: Tape shall be capable of sealing joints of adjacent sheets of plastic and for attachment of plastic sheet to finished or unfinished surfaces of dissimilar materials and capable of adhering under dry and wet conditions, including use of amended water. Minimum of 1.5" wide tape must be used.
- D. Disposal Containers: Disposal containers shall be suitable to receive and retain any asbestos-containing or contaminated materials until. The containers shall be labeled in accordance with OSHA and EPA regulations. Containers must be both air and water tight and have hard top, bottom and sides.
- E. Warning Labels and Signs: Warning labels and signs shall be posted as required by OSHA and EPA regulations.
- F. Solvents: NEUGENIC or Chem Clear or approved. All solvents must be safe to human health and the environment and must have a mild odor approved by the District. The contractor will be responsible for the elimination of any lingering odors resulting from the use of solvents.
- G. Surfactant (Wetting Agent): Surfactant shall consist of 50% polyoxyethelene ether and 50% polyethylene ester, or equivalent, and shall be mixed with water at a concentration of one ounce surfactant to 5 gallons of water (or as recommended by the manufacturer in the case of an equivalent) to produce amended water.
- H. Encapsulant: Shall be of the bridging or penetrating variety and shall be listed as "satisfactory" by the EPA.
- I. Rewettable Lagging Cloth: 12 oz. glass fabric lagging cloth saturated with dried lagging adhesive. "Dip-Lag" as manufactured by Claremont Co. or approved.
- J. Other Materials: Provide all other materials such as lumber, nails and hardware, which may be required to construct and dismantle the decontamination area and the barriers that isolate the work area, and as required to complete the Work as specified.

2.02 TOOLS AND EQUIPMENT:

- A. Water Sprayer: The water sprayer shall be an airless or other low pressure sprayer for amended water application.
- B. Air Filtration Machines: Air Filtration Machines shall consist of high efficiency particulate air (HEPA) filtration systems. No air movement system or air equipment shall discharge asbestos fibers outside the work

area. Each unit shall be capable of at least 1500 CFM under load and shall have at least 2 stages of pre-filtration ahead of the HEPA final filter. Each unit shall be equipped with an elapsed time indicator (hour meter), static pressure gauge with low flow alarm, and be overload protected. All exhaust must be vented to the outside of building.

- C. Water Purifying Equipment: Capable of removing all fibers longer than five microns from water used in abatement work and decontamination showers.
- D. Airless Sprayer: An airless sprayer, suitable for application of penetrating encapsulant material, shall be used.
- E. Vacuum Equipment: All vacuum equipment utilized in the work area shall be high efficiency particulate air (HEPA) equipment, and suitable for wet/dry usage.
- F. Scaffolding: Scaffolding, as required to accomplish the specified work, shall comply with all applicable safety regulations.
- G. Transportation Equipment: Transportation equipment, as required, shall be suitable for loading, temporary storage, transit, and unloading of contaminated waste without exposure to persons or property. If equipment is rented, notify rental agency in advance, in writing, of intended use of equipment.
- H. Electrical: Electrical tools, equipment and lighting shall meet all applicable codes and regulations. Ground fault protection, as required by OSHA, shall be in effect at all times. Contractor shall take all additional precautions and measures necessary to insure a safe working environment during wet removal.
- I. Vacuum Truck: If the contractor chooses to use a vacuum truck on this project they must submit written authorization from LRAPA and the Land Fill indicating the vacuum truck meets all applicable standards and is approved for use on this project. The contractor must also submit written approval from the disposal site that the waste will be accepted.
- J. Other Tools and Equipment: Provide other suitable tools for the removal, enclosure, encapsulation, patching, and disposal activities including, but not limited to: hand-held scrapers, wire brushes, sponges, and rounded-edge shovels.

### PART 3 - EXECUTION:

#### 3.01 ISOLATED WORK AREA ENCLOSURE:

- A. Work Area Preparation: The following isolation procedures shall be performed in the order in which they are presented.
  - 1. Shut down, remove filters and isolate HVAC systems to prevent further contamination and fiber dispersal as necessary. Coordinate with building users and the District prior to shut down.
  - 2. Seal off openings, including but not limited to doorways, windows, and other penetrations of the work area with plastic sheeting sealed with tape.
  - 3. Set up the worker decontamination enclosure system. Once these systems are installed, they shall be utilized in the specified manner for the ingress and egress of all personnel and equipment, except in emergency situations. All personnel shall sign the worksite entry logbook each time they pass in or out of the decontamination enclosure.

4. Coordinate the shut down, lock out and tag out of electrical and HVAC equipment with the District.
  5. Install air filtration machines to insure lower static pressure in the isolated work area than in surrounding areas. Discharge from air purifying equipment shall be ducted outside the building. Use one or more units of capacity as recommended by the manufacturer for the volume of the isolated work area, but in no case shall air flow be less than one air change every 15 minutes and the manometer reading is maintained at a minimum of 0.02. Column inches of water pressure differential. Air filtration machines shall remain in operation until final clearance samples have been received and containment has been removed.
  6. Pre-clean movable objects, within the work area using HEPA filtered vacuum equipment and/or wet cleaning methods as appropriate, and remove such objects from work areas to a temporary location, or consolidate such objects away from removal work and cover with plastic sheeting and tape as specified for fixed objects in 8 below.
  7. Pre-clean fixed objects within the proposed work areas, using HEPA filtered vacuum equipment and/or wet cleaning methods as appropriate, and enclose with minimum 4 mil plastic sheeting sealed with tape.
  8. Maintain emergency and fire exits from the work areas, or establish alternative exits satisfactory to the local building or fire department officials.
  9. Adequate portable fire extinguishing equipment shall be maintained within work area as defined by OSHA and/or local fire department officials.
- B. Work Area Maintenance: The Air Monitoring technician shall be responsible for daily reporting of the following to the District:
1. Prior to the first use and at the beginning of each shift during abatement work, enclosures shall be given a complete visual inspection by the shift foreman and Air Monitoring technician. This shall include inspection of the air filtration machines and associated filters. A smoke tube test shall then be made of the worker decontamination enclosure system and other critical areas to verify that the air filtration machines are working properly. Work shall not begin until all defects have been repaired.
  2. Periodic inspections shall be made as required during each shift to assure continued proper functioning of the enclosure and air filtration machines.
  3. The Contractor shall completely clean the decontamination enclosure system at the end of each shift, and the Air Monitoring technician shall verify that this is accomplished.

### 3.02 ASBESTOS ABATEMENT:

- A. Isolate and maintain work area as specified.
- B. Pre clean the work area as specified using HEPA filtered vacuum equipment and/or wet cleaning methods as appropriate, remove items through the decontamination enclosure system and store at another location on site as directed by the District.



- C. Remove asbestos containing materials using the following methods:
1. The asbestos material shall be sprayed with water containing an additive to enhance penetration. A fine spray of this solution shall be applied to prevent fiber disturbance preceding the removal of the asbestos material. The asbestos shall be sufficiently saturated to limit emission of airborne asbestos fibers
  2. Remove asbestos material while damp and pack in sealable plastic bags (6 mil minimum thickness). Wash outside surface and place inside a second plastic bag (6 mil minimum thickness) bearing EPA warning label. Place double bagged materials in labeled containers for transport. In lieu of 6ml. polyurethane bags, contractor may use lined cardboard, plastic, or metal drums or cubic yard boxes as allowed by Federal, State, and local regulatory agency.
  3. Removal of asbestos containing flooring shall be performed under full negative pressure containment with an attached decontamination facility and utilizing wet methods.
  4. After completion of stripping work, all surfaces from which asbestos has been removed shall be brushed and/or wet sponged or cleaned by an equivalent method to remove all visible material. During this work the surfaces being cleaned shall be kept wet.
- D. Vacuum all walls, ceilings, and floors in the work area to ensure complete removal of all dust and debris that may remain.
- E. Apply a clear penetrating encapsulant to all walls and ceilings following the final visual inspection and approval from the district. **Minimize the amount of encapsulant applied to the floor.**

### 3.03 AIR SAMPLES

- A. If, at any time during the Work, analysis of an air sample indicates a fiber count in excess of the allowable maximums specified above, the Air Monitoring Technician who analyzed the air sample shall immediately notify.
1. The Contractor's foreman.
  2. 4J School District Safety Office Specialist, Doug Lemonds or other authorized district representative at 541-790-7432 or 541-915-9068.
- B. Immediately upon being notified of fiber count exceeding the specified maximum allowable levels, the Contractor shall:
1. Stop removal work.
  2. Clean the area in which the high fiber count air sample was taken. If air sample was taken outside the isolated work area, evacuate all non-abatement personnel.
  3. Resample air until fiber counts are determined to be below specified maximum levels.
  4. Recheck work procedures, barriers, equipment, etc., to discover possible cause of high fiber counts.
  5. Carefully resume Work under close air monitoring.

#### 3.04 FINAL AIR CLEARANCE TESTING

- A. When the contractor considers the work to be complete, Notify the District Representative in writing. The District Representative will review the work with the contractor and note those areas requiring corrective action. Upon completion, the contractor will again notify the District in writing of completion of work. The District Representative will arrange for final air clearance sampling by an independent air monitoring firm.
- B. Upon the District's receipt of written results indicating that level of airborne asbestos meet the AHERA clearance requirements, the District will provide the contractor with written authorization to remove containment, decontamination chambers, and air filtration machines.
- C. The cost of the first set of air clearance samples (TEM or PCM) will be paid by the District. Should the clearance sample result indicate that additional work is required; the Contractor shall perform such work and call for retesting. All costs of second or subsequent air clearance testing shall be paid by the Contractor.
- D. The District will make one review for completion. District personnel time required for additional reviews caused by incomplete work shall be paid by Contractor. Costs shall include fringe benefits.

#### 3.05 RE-ESTABLISHMENT OF OBJECTS AND SYSTEMS:

- A. When clean-up is complete and final clearance samples are at or below the required AHERA levels and authorized by the District the contractor will:
  - 1. Remove containment, decontamination chambers, and negative air machines.
  - 2. Relocate objects moved to temporary locations in the course of the Work to their former positions. Coordinate with the District.
  - 3. Re-secure objects removed in the course of Work in their former positions, including air dampers in plenums, and adjust for proper operations.
  - 4. Clean, repair and/or repaint all surfaces soiled, discolored or damaged by removal of tape, adhesive or other Work of this Contract to match adjacent surfaces.

#### 3.06 DISPOSAL:

- A. Warning labels having waterproof print and permanent adhesive, shall be affixed to the lid and sides of all containers. Warning labels shall be conspicuous and legible, and contain the following words:

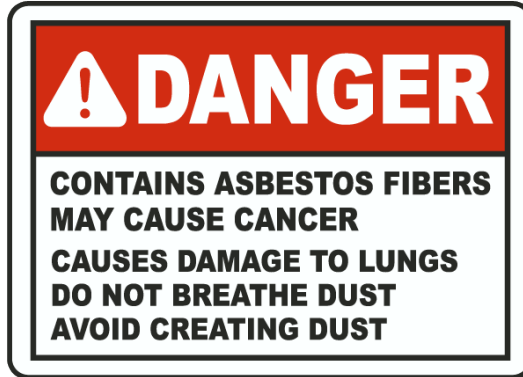

- B. The Contractor shall determine current waste handling, transportation, and disposal regulations for the Work Site and for each waste disposal landfill. The Contractor shall comply fully with these regulations and all U.S. Department of Transportation, DEQ, MSD EPA requirements. All material in containers shall be delivered to the pre-designated disposal site double bagged for burial. Labels and all necessary signs shall be in accordance with EPA, OSHA, State, and/or local standards.
- C. Decontaminated containers shall be removed from Site as soon as possible. Notify disposal site in advance of delivery of material to assure immediate burial of material.
- D. If bags are broken or damaged, or a container is contaminated, the entire container shall be cleaned and decontaminated, damaged bags shall be placed in undamaged bags before disposal.
- E. Written proof of disposal at approved disposal (waste Shipment records) site shall be submitted to the District prior to final payment.

END OF SECTION 02080

**GENERAL NOTES**

1. THIS DRAWING IS DIAGRAMMATIC. IT IS FOR GENERAL INFORMATION.
2. ALL ABOVE-SLAB PHASE I, PART 1 WORK MAY BEGIN ON JUNE 23, 2016 AND SHALL BE COMPLETE BY JUNE 30, 2016 UNLESS OTHERWISE NOTED.
3. PHASE I, PART 1 AND PART 2 ROOFING REMOVAL OVER THE GYMNASIUMS MAY BEGIN ON JUNE 17, 2016.
4. PORTABLE CLASSROOM D12 WORK MAY BEGIN ON JUNE 20, 2016, AND SHALL BE COMPLETE BY JUNE 26, 2016.
5. ALL ABOVE-SLAB PHASE I, PART 2 WORK MAY BEGIN ON JUNE 24, 2016 AND SHALL BE COMPLETE BY JULY 17, 2016 UNLESS OTHERWISE NOTED.
6. ABATEMENT CONTRACTOR SHALL COORDINATE WITH DEMOLITION CONTRACTOR TO ACCESS AND ABATE SUB-SLAB ASBESTOS-CONTAINING MATERIALS.

**PHASE 1, PART 1**

START: JUNE 23, 2016  
COMPLETION: JUNE 30, 2016

**PHASE 1, PART 2**

START: JUNE 24, 2016  
COMPLETION: JULY 17, 2016



**FIRST FLOOR PLAN**

HAZARDOUS
MATERIAL
ABATEMENT
PHASING PLAN

PROJECT:	52141.003
DRAWN:	JAB
CHECKED:	JH
DATE:	JANUARY 2016

FIGURE:	SHEET:
HM1	1 OF 9

L:\Projects\52141\52141-01\PHASING\14\_01\PHASING.dwg, 14\_01\_2016 09:15:00, JAB, JH, Jan 12, 2016 09:15:00, jab









**GENERAL NOTES**

- THIS DRAWING IS DIAGRAMMATIC. IT IS FOR GENERAL INFORMATION.
- CONTRACTOR SHALL FIELD VERIFY ALL DIMENSIONS, MATERIAL QUANTITIES, ITEMS TO BE DEMOLISHED, AND ITEMS TO BE SAVED AND PROTECTED.
- CONTRACTOR SHALL BECOME KNOWLEDGEABLE WITH EXTRACTION POINT LOCATIONS AND LIMITATIONS, AND VERIFY ALL EXTRACTION POINT MEASUREMENTS IN THE FIELD.
- CONTRACTOR SHALL COORDINATE ALL WORK WITH THE OWNER INCLUDING BUT NOT LIMITED TO SCHEDULING, ACCESS, SECURITY, STAGING, PROTECT AND SAVE ITEMS, SALVAGE, LOCKOUT/TAGOUT, AND DEMOLITION ACTIVITIES.
- ALL CONTRACTORS AND SUB-CONTRACTORS PERFORMING ABATEMENT AND DEMOLITION TASKS ON PAINTED SURFACES SHALL COMPLY WITH ALL APPLICABLE LEAD PAINT REGULATIONS IN OAR 437-DIVISION 3, 1926.62 LEAD IN CONSTRUCTION STANDARD.
- CONTRACTOR SHALL REMOVE AND DISPOSE OF ALL BUILDING FINISHES, FURNISHINGS, CASEWORK, MECHANICAL EQUIPMENT, AND ALL OTHER OBSTRUCTIONS TO ACCESS ASBESTOS-CONTAINING MATERIALS TO BE REMOVED.
- CLEANUP AND DISPOSAL OF ALL GENERAL WASTE GENERATED AS A RESULT OF DEMOLITION ACTIVITIES SHALL BE THE RESPONSIBILITY OF THE CONTRACTOR.
- CONTRACTOR SHALL VERIFY WITH THE OWNER, SPECIFIC ITEMS TO BE SAVED AND PROTECTED PRIOR TO THE START OF ABATEMENT AND DEMOLITION WORK.
- PROTECT ALL SYSTEMS OUTSIDE THE SCOPE OF WORK OF THIS PROJECT FROM DAMAGE AS A RESULT OF WORK INCLUDED IN THIS PROJECT, AND PROTECT ALL ITEMS SPECIFICALLY INDICATED IN THESE SPECIFICATIONS.
- COORDINATE DISCONNECTION AND DE-ENERGIZING OF ALL OPERATIONAL COMPONENTS WITH OWNER PRIOR TO THE START OF ASBESTOS ABATEMENT AND DEMOLITION WORK.

**ABATEMENT NOTES**

- REMOVE AND DISPOSE OF ALL ASBESTOS-CONTAINING MATERIALS IDENTIFIED ON THE ABATEMENT DRAWINGS AND IN THE SECTION 01 11 00 SUMMARY OF WORK. DRAWINGS DO NOT SHOW ALL ASBESTOS-CONTAINING MATERIALS TO BE REMOVED. REFER TO THE ABATEMENT NOTES AND SUMMARY OF WORK SECTION 01 11 00 FOR ADDITIONAL DETAILS AND TASKS INCLUDED IN THE PROJECT SCOPE OF WORK.
- FLOORING SUBSTRATES ARE CONCRETE UNLESS NOTED OTHERWISE.
- MULTIPLE LAYERS OF CARPET ARE PRESENT IN ROOMS A5, D10, AND D11.
- REMNANT ASBESTOS-CONTAINING FLOOR TILE AND MASTIC ARE ASSUMED TO BE PRESENT IN PREVIOUSLY ABATED AREAS UNDER CASEWORK AND OTHER FIXTURES. CONTRACTOR SHALL PERFORM SELECTIVE DEMOLITION TO VERIFY THE ABSENCE OR PRESENCE OF CONCEALED FLOOR TILE AND MASTIC WHERE INDICATED.
- THE CONTRACTOR SHALL BE RESPONSIBLE FOR CLEANING OR REMOVAL AND DISPOSAL OF ANY ITEMS THAT BECOME CONTAMINATED AS A RESULT OF ASBESTOS ABATEMENT WORK.
- CONTRACTOR SHALL CAPTURE ALL WATER USED DURING ASBESTOS ABATEMENT AND FILTER PRIOR TO DISCHARGE INTO MUNICIPAL WATER SYSTEM.

**LEGEND**

-  NON-ASBESTOS FLOOR TILE WITH ASBESTOS-CONTAINING MASTIC
-  ASBESTOS-CONTAINING FLOOR TILE WITH NON-ASBESTOS MASTIC ON PLYWOOD SUBSTRATE
-  ASBESTOS-CONTAINING FLOOR TILE AND MASTIC
-  ASBESTOS-CONTAINING FLOOR TILE AND MASTIC ON PLYWOOD SUBSTRATE
-  ASBESTOS-CONTAINING FLOOR TILE AND MASTIC CONCEALED UNDER CARPET
-  ASBESTOS-CONTAINING FLOOR TILE WITH NON-ASBESTOS MASTIC
-  ASBESTOS-CONTAINING SHEET VINYL FLOOR COVERING

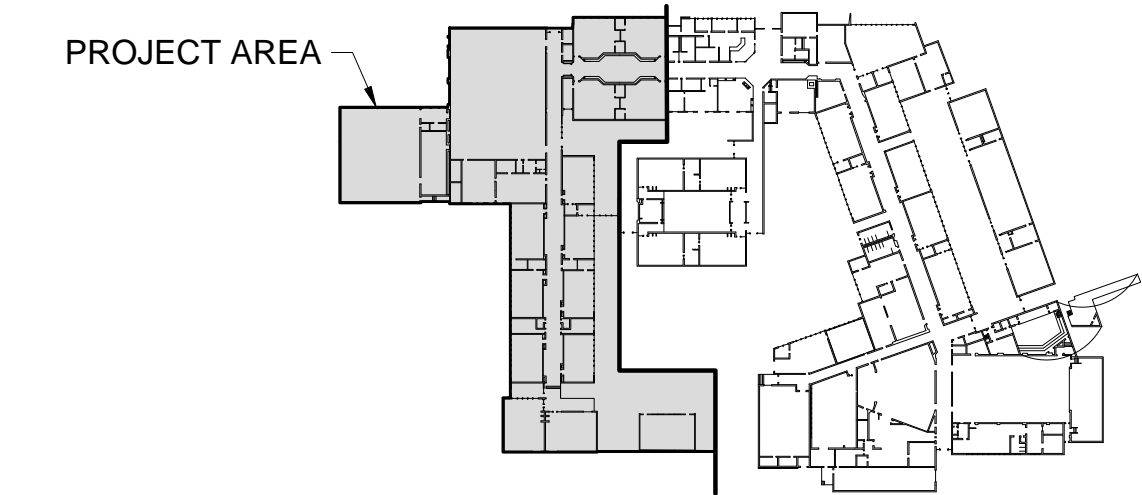

**KEY PLAN**

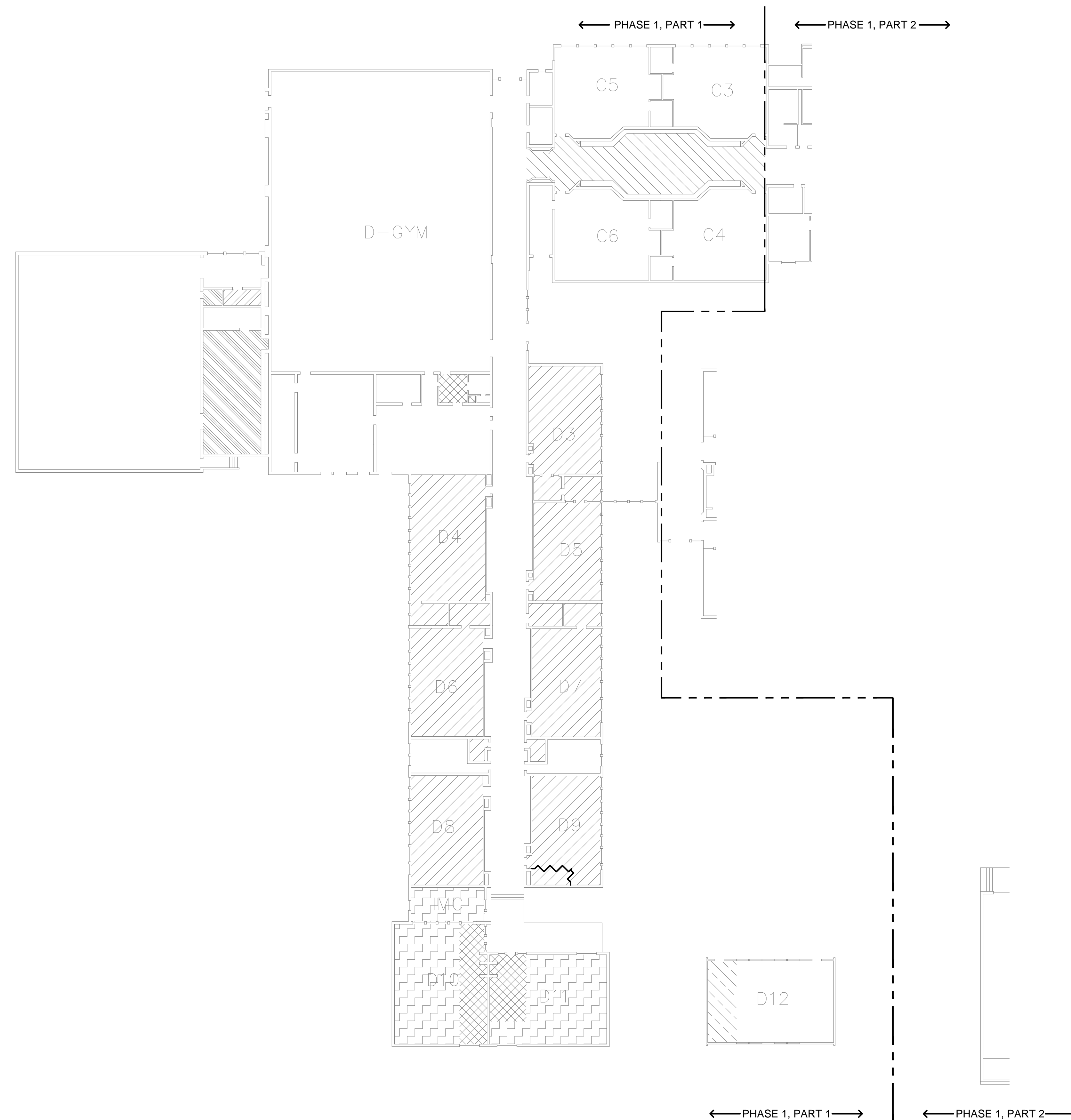

**PARTIAL FIRST FLOOR PLAN - FLOORING MATERIALS**

<b>HAZARDOUS</b>
<b>MATERIAL</b>
<b>ABATEMENT</b>
<b>PLAN</b>

PROJECT:	52141.003
DRAWN:	JAB
CHECKED:	JH
DATE:	JANUARY 2016

FIGURE:	2
SHEET:	OF 9

L:\Projects\52000\52141\_003\52141\_003\_Roosevelt\_M\_Survey\DWG\Abatement\52141\_003\_HM2.dwg, Jan 13, 2016 02:50pm, jmh

**GENERAL NOTES**

- THIS DRAWING IS DIAGRAMMATIC. IT IS FOR GENERAL INFORMATION.
- CONTRACTOR SHALL FIELD VERIFY ALL DIMENSIONS, MATERIAL QUANTITIES, ITEMS TO BE DEMOLISHED, AND ITEMS TO BE SAVED AND PROTECTED.
- CONTRACTOR SHALL BECOME KNOWLEDGEABLE WITH EXTRACTION POINT LOCATIONS AND LIMITATIONS, AND VERIFY ALL EXTRACTION POINT MEASUREMENTS IN THE FIELD.
- CONTRACTOR SHALL COORDINATE ALL WORK WITH THE OWNER INCLUDING BUT NOT LIMITED TO SCHEDULING, ACCESS, SECURITY, STAGING, PROTECT AND SAVE ITEMS, SALVAGE, LOCKOUT/TAGOUT, AND DEMOLITION ACTIVITIES.
- ALL CONTRACTORS AND SUB-CONTRACTORS PERFORMING ABATEMENT AND DEMOLITION TASKS ON PAINTED SURFACES SHALL COMPLY WITH ALL APPLICABLE LEAD PAINT REGULATIONS IN OAR 437-DIVISION 3, 1926.62 LEAD IN CONSTRUCTION STANDARD.
- CONTRACTOR SHALL REMOVE AND DISPOSE OF ALL BUILDING FINISHES, FURNISHINGS, CASEWORK, MECHANICAL EQUIPMENT, AND ALL OTHER OBSTRUCTIONS TO ACCESS ASBESTOS-CONTAINING MATERIALS TO BE REMOVED.
- CLEANUP AND DISPOSAL OF ALL GENERAL WASTE GENERATED AS A RESULT OF DEMOLITION ACTIVITIES SHALL BE THE RESPONSIBILITY OF THE CONTRACTOR.
- CONTRACTOR SHALL VERIFY WITH THE OWNER, SPECIFIC ITEMS TO BE SAVED AND PROTECTED PRIOR TO THE START OF ABATEMENT AND DEMOLITION WORK.
- PROTECT ALL SYSTEMS OUTSIDE THE SCOPE OF WORK OF THIS PROJECT FROM DAMAGE AS A RESULT OF WORK INCLUDED IN THIS PROJECT, AND PROTECT ALL ITEMS SPECIFICALLY INDICATED IN THESE SPECIFICATIONS.
- COORDINATE DISCONNECTION AND DE-ENERGIZING OF ALL OPERATIONAL COMPONENTS WITH OWNER PRIOR TO THE START OF ASBESTOS ABATEMENT AND DEMOLITION WORK.





**ABATEMENT NOTES**

- REMOVE AND DISPOSE OF ALL ASBESTOS-CONTAINING MATERIALS IDENTIFIED ON THE ABATEMENT DRAWINGS AND IN THE SECTION 01 11 00 SUMMARY OF WORK. DRAWINGS DO NOT SHOW ALL ASBESTOS-CONTAINING MATERIALS TO BE REMOVED. REFER TO THE ABATEMENT NOTES AND SUMMARY OF WORK SECTION 01 11 00 FOR ADDITIONAL DETAILS AND TASKS INCLUDED IN THE PROJECT SCOPE OF WORK.
- FLOORING SUBSTRATES ARE CONCRETE UNLESS NOTED OTHERWISE.
- MULTIPLE LAYERS OF CARPET ARE PRESENT IN ROOMS A5, D10, AND D11.
- REMNANT ASBESTOS-CONTAINING FLOOR TILE AND MASTIC ARE ASSUMED TO BE PRESENT IN PREVIOUSLY ABATED AREAS UNDER CASEWORK AND OTHER FIXTURES. CONTRACTOR SHALL PERFORM SELECTIVE DEMOLITION TO VERIFY THE ABSENCE OR PRESENCE OF CONCEALED FLOOR TILE AND MASTIC WHERE INDICATED.
- THE CONTRACTOR SHALL BE RESPONSIBLE FOR CLEANING OR REMOVAL AND DISPOSAL OF ANY ITEMS THAT BECOME CONTAMINATED AS A RESULT OF ASBESTOS ABATEMENT WORK.
- CONTRACTOR SHALL CAPTURE ALL WATER USED DURING ASBESTOS ABATEMENT AND FILTER PRIOR TO DISCHARGE INTO MUNICIPAL WATER SYSTEM.



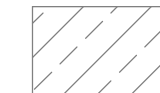

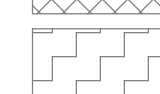
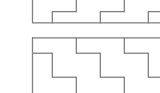
**KEY NOTES (THIS SHEET)**

- THEATER CONTROL ROOM LOFT AND STAIRS WITH ASBESTOS-CONTAINING FLOOR TILE AND MASTIC ON PARTICLE BOARD (NOT SHOWN ON DRAWING).
- PERFORM SELECTIVE DEMOLITION OF CASEWORK AND FLOOR-MOUNTED FIXTURES TO ACCESS POTENTIAL REMNANT ASBESTOS-CONTAINING FLOOR TILE AND MASTIC.

**LEGEND**

-  NON-ASBESTOS FLOOR TILE WITH ASBESTOS-CONTAINING MASTIC
-  ASBESTOS-CONTAINING FLOOR TILE WITH NON-ASBESTOS MASTIC ON PLYWOOD SUBSTRATE
-  ASBESTOS-CONTAINING FLOOR TILE AND MASTIC
-  ASBESTOS-CONTAINING FLOOR TILE AND MASTIC CONCEALED UNDER CARPET
-  ASBESTOS-CONTAINING FLOOR TILE AND NON-ASBESTOS MASTIC CONCEALED UNDER CARPET
-  ASBESTOS-CONTAINING SHEET VINYL FLOOR COVERING
-  ASBESTOS-CONTAINING SHEET VINYL FLOOR COVERING CONCEALED UNDER CARPET

**LEGEND (CONTINUED)**

-  ASBESTOS-CONTAINING FLOOR TILE WITH NON-ASBESTOS MASTIC
-  ASBESTOS-CONTAINING FLOOR TILE AND MASTIC CONCEALED UNDER STAGE
-  ASBESTOS-CONTAINING FLOOR TILE ASSUMED TO BE PRESENT UNDER ADDED WALL
-  COVEBASE WITH ASBESTOS-CONTAINING MASTIC OR RESIDUAL ASBESTOS-CONTAINING MASTIC PRESENT ON WALLS, CASEWORK, AND FIXTURES

← PHASE 1, PART 1 →

← PHASE 1, PART 2 →

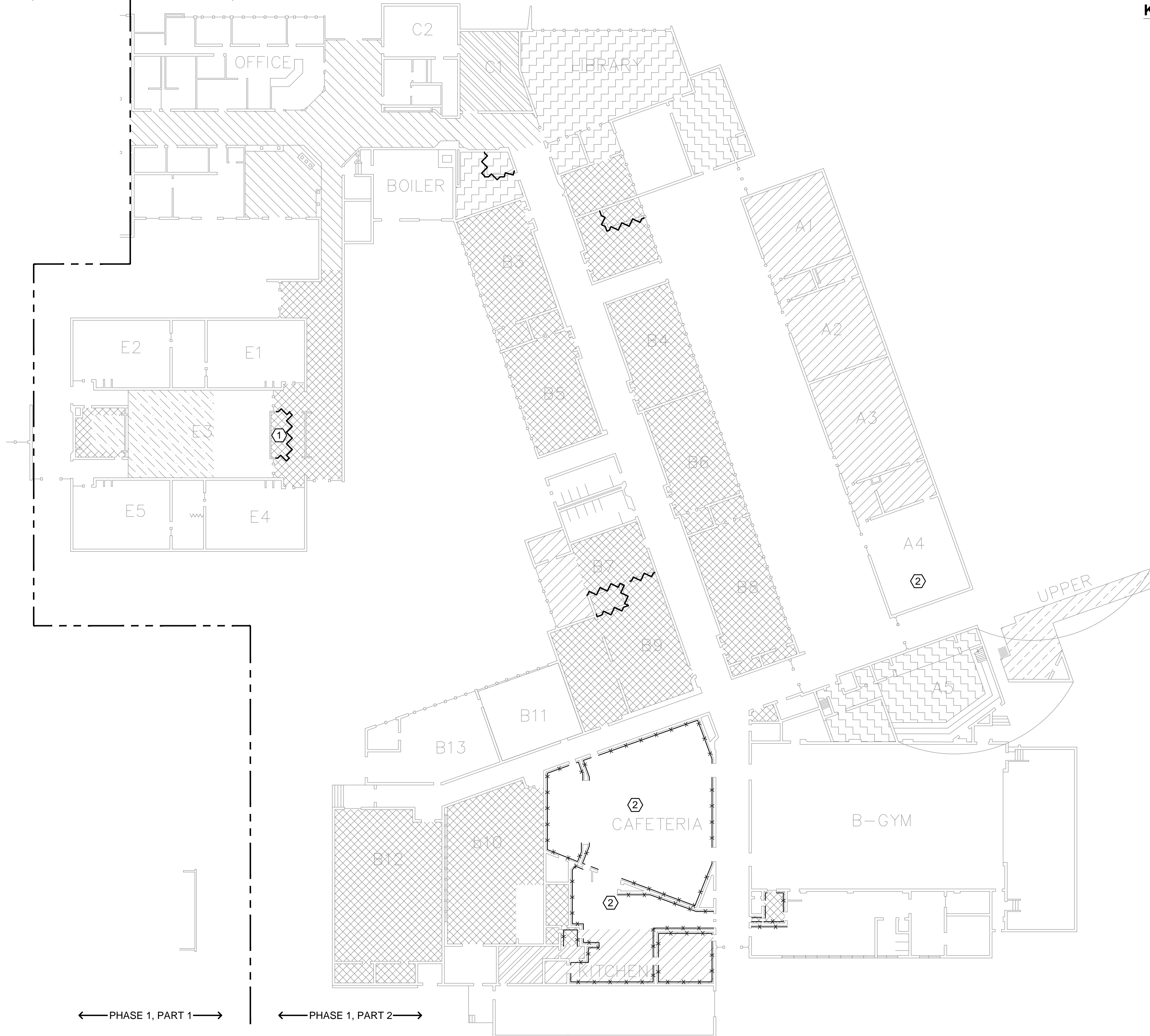

← PHASE 1, PART 1 →

← PHASE 1, PART 2 →

**PARTIAL FIRST FLOOR PLAN - FLOORING MATERIALS**

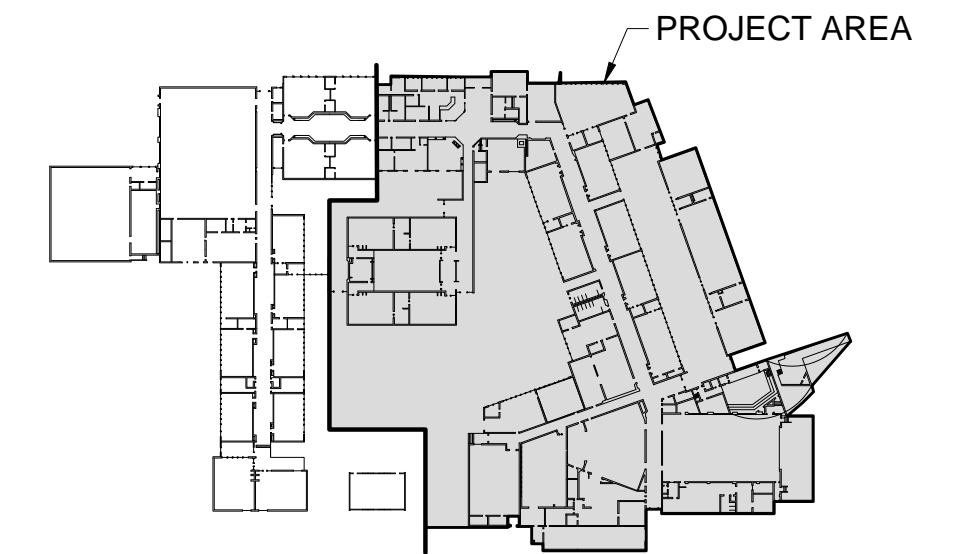

**KEY PLAN**

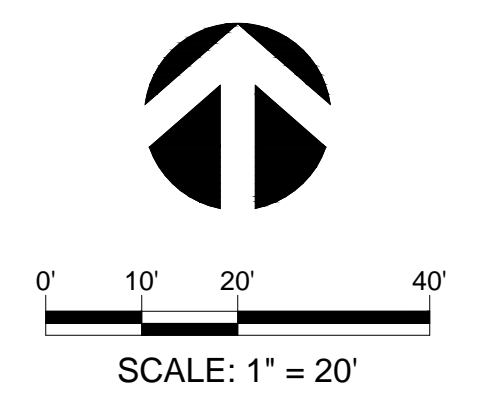

L:\Projects\2020\2020-01-09-19982141\_43\_20200214\_P03\_Roosevelt\_M\_Survey\DWG\Abatement\2021\_11\_03\_13\_2020\_03131pm.dwg

**GENERAL NOTES**

- THIS DRAWING IS DIAGRAMMATIC. IT IS FOR GENERAL INFORMATION.
- CONTRACTOR SHALL FIELD VERIFY ALL DIMENSIONS, MATERIAL QUANTITIES, ITEMS TO BE DEMOLISHED, AND ITEMS TO BE SAVED AND PROTECTED.
- CONTRACTOR SHALL BECOME KNOWLEDGEABLE WITH EXTRACTION POINT LOCATIONS AND LIMITATIONS, AND VERIFY ALL EXTRACTION POINT MEASUREMENTS IN THE FIELD.
- CONTRACTOR SHALL COORDINATE ALL WORK WITH THE OWNER INCLUDING BUT NOT LIMITED TO SCHEDULING, ACCESS, SECURITY, STAGING, PROTECT AND SAVE ITEMS, SALVAGE, LOCKOUT/TAGOUT, AND DEMOLITION ACTIVITIES.
- ALL CONTRACTORS AND SUB-CONTRACTORS PERFORMING ABATEMENT AND DEMOLITION TASKS ON PAINTED SURFACES SHALL COMPLY WITH ALL APPLICABLE LEAD PAINT REGULATIONS IN OAR 437-DIVISION 3, 1926.62 LEAD IN CONSTRUCTION STANDARD.
- CONTRACTOR SHALL REMOVE AND DISPOSE OF ALL BUILDING FINISHES, FURNISHINGS, CASEWORK, MECHANICAL EQUIPMENT, AND ALL OTHER OBSTRUCTIONS TO ACCESS ASBESTOS-CONTAINING MATERIALS TO BE REMOVED.
- CLEANUP AND DISPOSAL OF ALL GENERAL WASTE GENERATED AS A RESULT OF DEMOLITION ACTIVITIES SHALL BE THE RESPONSIBILITY OF THE CONTRACTOR.
- CONTRACTOR SHALL VERIFY WITH THE OWNER, SPECIFIC ITEMS TO BE SAVED AND PROTECTED PRIOR TO THE START OF ABATEMENT AND DEMOLITION WORK.
- PROTECT ALL SYSTEMS OUTSIDE THE SCOPE OF WORK OF THIS PROJECT FROM DAMAGE AS A RESULT OF WORK INCLUDED IN THIS PROJECT, AND PROTECT ALL ITEMS SPECIFICALLY INDICATED IN THESE SPECIFICATIONS.
- COORDINATE DISCONNECTION AND DE-ENERGIZING OF ALL OPERATIONAL COMPONENTS WITH OWNER PRIOR TO THE START OF ASBESTOS ABATEMENT AND DEMOLITION WORK.

**ABATEMENT NOTES**

- REMOVE AND DISPOSE OF ALL ASBESTOS-CONTAINING MATERIALS IDENTIFIED ON THE ABATEMENT DRAWINGS AND IN THE SECTION 01 11 00 SUMMARY OF WORK. DRAWINGS DO NOT SHOW ALL ASBESTOS-CONTAINING MATERIALS TO BE REMOVED. REFER TO THE ABATEMENT NOTES AND SUMMARY OF WORK SECTION 01 11 00 FOR ADDITIONAL DETAILS AND TASKS INCLUDED IN THE PROJECT SCOPE OF WORK.
- THE SCOPE OF WORK INCLUDES REMOVAL AND DISPOSAL OF ALL ASBESTOS-CONTAINING PIPE AND PIPE FITTING INSULATION THROUGHOUT THE BUILDING. GENERAL LOCATIONS AND KNOWN QUANTITIES ARE INDICATED ON THE DRAWINGS. ADDITIONAL INSULATION IS KNOWN TO BE PRESENT IN CONCEALED LOCATIONS (ABOVE CEILINGS, BELOW FLOORS, INSIDE WALL CAVITIES AND PIPE CHASES, AND IN SUB-FLOOR PIPE TRENCHES). CONTRACTOR SHALL PERFORM SELECTIVE DEMOLITION AS NECESSARY TO EXPOSE PIPING AND REMOVE ALL EXISTING INSULATION.
- CONCEALED PIPE INSULATION DEPICTED ON THIS DRAWING IS FOR GENERAL INFORMATION. SINGLE PIPE RUNS SHOWN ON THIS DRAWING MAY REPRESENT MULTIPLE ACTUAL PIPE RUNS. LOCATIONS ARE TO BE CONSIDERED ESTIMATES ONLY, AND ARE BASED ON LIMITED FIELD OBSERVATIONS AND HISTORIC BUILDING PLANS.
- ASBESTOS INSULATED SUB-SLAB STEAM SUPPLY AND CONDENSATE RETURN PIPING UNDER THE ORIGINAL BUILDING IS CONTAINED WITHIN CLAY OR CONCRETE TILE SLEEVES.
- THE CONTRACTOR SHALL BE RESPONSIBLE FOR CLEANING OR REMOVAL AND DISPOSAL OF ANY ITEMS THAT BECOME CONTAMINATED AS A RESULT OF ASBESTOS ABATEMENT WORK.
- ALL ASBESTOS ABATEMENT AND ALL DEMOLITION WORK THAT MAY IMPACT ASBESTOS-CONTAINING MATERIALS SHALL BE CONDUCTED WITHIN A NEGATIVE PRESSURE ENCLOSURE.
- CONTRACTOR SHALL CAPTURE ALL WATER USED DURING ASBESTOS ABATEMENT AND FILTER PRIOR TO DISCHARGE INTO MUNICIPAL WATER SYSTEM.

**LEGEND**

- \* ASBESTOS-CONTAINING PIPE AND/OR PIPE FITTING INSULATION ASSUMED TO BE PRESENT ABOVE CEILING OR WITHIN PIPE CHASE/WALL CAVITY
- ⊙ APPROXIMATE LOCATION OF PIPE PENETRATIONS THROUGH CONCRETE SLAB FOR RADIATOR CONNECTIONS. ASBESTOS-CONTAINING PIPE INSULATION ASSUMED TO BE PRESENT
- ASBESTOS-CONTAINING PIPE AND/OR PIPE FITTING INSULATION ASSUMED TO BE PRESENT ABOVE CEILING OR WITHIN PIPE CHASE.
- ASBESTOS-CONTAINING PIPE AND/OR PIPE FITTING INSULATION ASSUMED TO BE PRESENT UNDER CONCRETE SLAB
- ASBESTOS-CONTAINING PIPE AND/OR PIPE FITTING INSULATION UNDER WOOD FLOOR
- SUB-SLAB ASBESTOS-CONTAINING PIPE AND/OR PIPE FITTING INSULATION CONTAINED WITHIN CEMENT ASBESTOS TILE SLEEVE

**LEGEND (CONTINUED)**

- ① ASBESTOS-CONTAINING PIPE FITTING INSULATION (10-EACH) IN MECHANICAL LOFT/ATTIC
- ② ASBESTOS-CONTAINING PIPE INSULATION AND PIPE INSULATION DEBRIS IN ATTIC SPACE
- ③ ASBESTOS-CONTAINING PIPE INSULATION DEBRIS IN DIRT FLOOR CRAWLSPACE
- ④ REMNANT ASBESTOS-CONTAINING PIPE INSULATION IN CRAWLSPACE AT PIPE PENETRATION THROUGH CONCRETE FLOOR JOIST

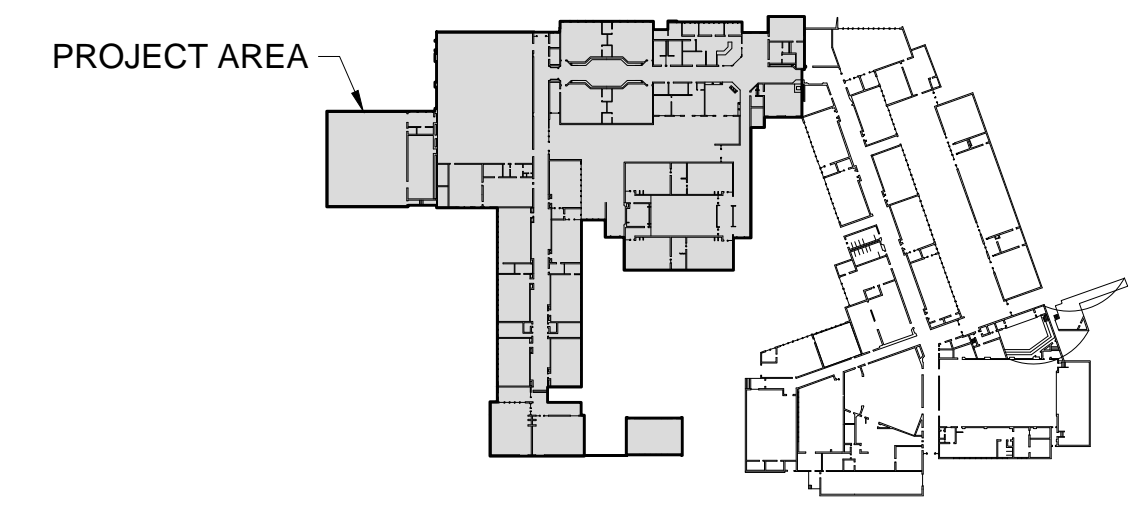

**KEY PLAN**

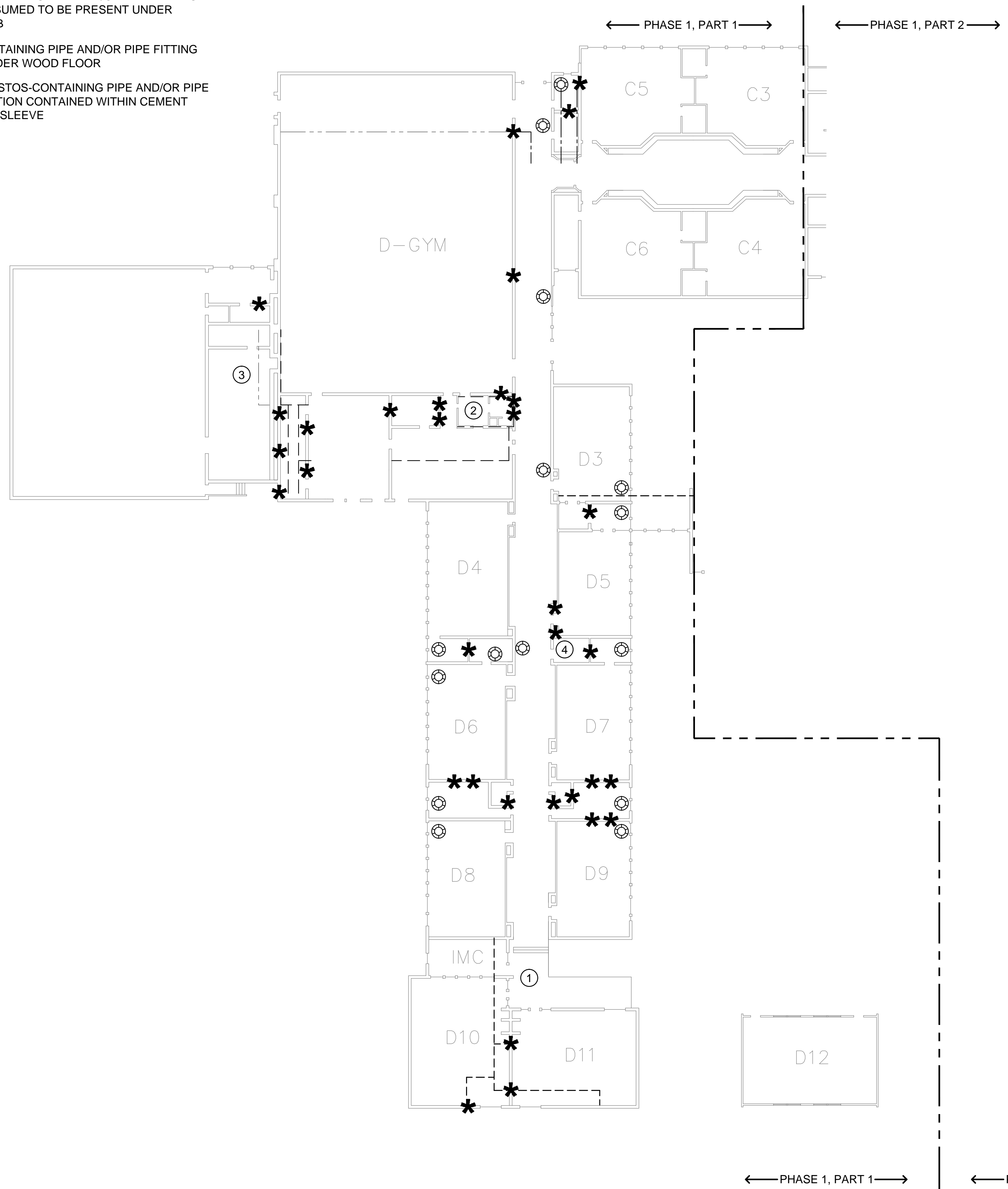

**PARTIAL FIRST FLOOR PLAN - THERMAL SYSTEM INSULATION**

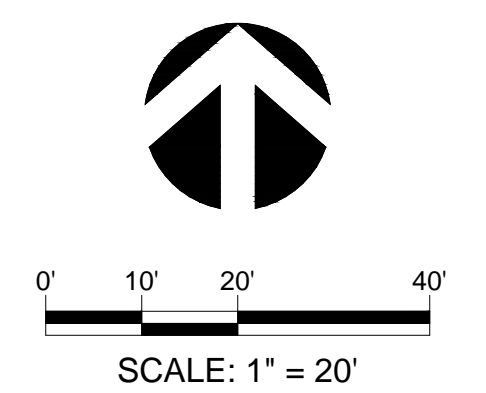

HAZARDOUS
MATERIAL
ABATEMENT
PLAN

PROJECT:	52141.003
DRAWN:	JAB
CHECKED:	JH
DATE:	JANUARY 2016

L:\Projects\52141\52141-01\52141-01-1000\52141-01-1000-Roosevelt MS Survey\DWG\Abatement\52141\_003\_HM4.dwg, Jan 13, 2016 02:51 pm, jmh



**GENERAL NOTES**

- THIS DRAWING IS DIAGRAMMATIC. IT IS FOR GENERAL INFORMATION.
- CONTRACTOR SHALL FIELD VERIFY ALL DIMENSIONS, MATERIAL QUANTITIES, ITEMS TO BE DEMOLISHED, AND ITEMS TO BE SAVED AND PROTECTED.
- CONTRACTOR SHALL BECOME KNOWLEDGEABLE WITH EXTRACTION POINT LOCATIONS AND LIMITATIONS, AND VERIFY ALL EXTRACTION POINT MEASUREMENTS IN THE FIELD.
- CONTRACTOR SHALL COORDINATE ALL WORK WITH THE OWNER INCLUDING BUT NOT LIMITED TO SCHEDULING, ACCESS, SECURITY, STAGING, PROTECT AND SAVE ITEMS, SALVAGE, LOCKOUT/TAGOUT, AND DEMOLITION ACTIVITIES.
- ALL CONTRACTORS AND SUB-CONTRACTORS PERFORMING ABATEMENT AND DEMOLITION TASKS ON PAINTED SURFACES SHALL COMPLY WITH ALL APPLICABLE LEAD PAINT REGULATIONS IN OAR 437-DIVISION 3, 1926.62 LEAD IN CONSTRUCTION STANDARD.
- CONTRACTOR SHALL REMOVE AND DISPOSE OF ALL BUILDING FINISHES, FURNISHINGS, CASEWORK, MECHANICAL EQUIPMENT, AND ALL OTHER OBSTRUCTIONS TO ACCESS ASBESTOS-CONTAINING MATERIALS TO BE REMOVED.
- CLEANUP AND DISPOSAL OF ALL GENERAL WASTE GENERATED AS A RESULT OF DEMOLITION ACTIVITIES SHALL BE THE RESPONSIBILITY OF THE CONTRACTOR.
- CONTRACTOR SHALL VERIFY WITH THE OWNER, SPECIFIC ITEMS TO BE SAVED AND PROTECTED PRIOR TO THE START OF ABATEMENT AND DEMOLITION WORK.
- PROTECT ALL SYSTEMS OUTSIDE THE SCOPE OF WORK OF THIS PROJECT FROM DAMAGE AS A RESULT OF WORK INCLUDED IN THIS PROJECT, AND PROTECT ALL ITEMS SPECIFICALLY INDICATED IN THESE SPECIFICATIONS.
- COORDINATE DISCONNECTION AND DE-ENERGIZING OF ALL OPERATIONAL COMPONENTS WITH OWNER PRIOR TO THE START OF ASBESTOS ABATEMENT AND DEMOLITION WORK.

**ABATEMENT NOTES**

- REMOVE AND DISPOSE OF ALL ASBESTOS-CONTAINING MATERIALS IDENTIFIED ON THE ABATEMENT DRAWINGS AND IN THE SECTION 01 11 00 SUMMARY OF WORK. DRAWINGS DO NOT SHOW ALL ASBESTOS-CONTAINING MATERIALS TO BE REMOVED. REFER TO THE ABATEMENT NOTES AND SUMMARY OF WORK SECTION 01 11 00 FOR ADDITIONAL DETAILS AND TASKS INCLUDED IN THE PROJECT SCOPE OF WORK.
- THE SCOPE OF WORK INCLUDES REMOVAL AND DISPOSAL OF ALL ASBESTOS-CONTAINING PIPE AND PIPE FITTING INSULATION THROUGHOUT THE BUILDING. GENERAL LOCATIONS AND KNOWN QUANTITIES ARE INDICATED ON THE DRAWINGS. ADDITIONAL INSULATION IS KNOWN TO BE PRESENT IN CONCEALED LOCATIONS (ABOVE CEILINGS, BELOW FLOORS, INSIDE WALL CAVITIES AND PIPE CHASES, AND IN SUB-FLOOR PIPE TRENCHES). CONTRACTOR SHALL PERFORM SELECTIVE DEMOLITION AS NECESSARY TO EXPOSE PIPING AND REMOVE ALL EXISTING INSULATION.
- CONCEALED PIPE INSULATION DEPICTED ON THIS DRAWING IS FOR GENERAL INFORMATION. SINGLE PIPE RUNS SHOWN ON THIS DRAWING MAY REPRESENT MULTIPLE ACTUAL PIPE RUNS. LOCATIONS ARE TO BE CONSIDERED ESTIMATES ONLY, AND ARE BASED ON LIMITED FIELD OBSERVATIONS AND HISTORIC BUILDING PLANS.
- ASBESTOS INSULATED SUB-SLAB STEAM SUPPLY AND CONDENSATE RETURN PIPING UNDER THE ORIGINAL BUILDING IS CONTAINED WITHIN CLAY OR CONCRETE TILE SLEEVES.
- THE CONTRACTOR SHALL BE RESPONSIBLE FOR CLEANING OR REMOVAL AND DISPOSAL OF ANY ITEMS THAT BECOME CONTAMINATED AS A RESULT OF ASBESTOS ABATEMENT WORK.
- ALL ASBESTOS ABATEMENT AND ALL DEMOLITION WORK THAT MAY IMPACT ASBESTOS-CONTAINING MATERIALS SHALL BE CONDUCTED WITHIN A NEGATIVE PRESSURE ENCLOSURE.
- CONTRACTOR SHALL CAPTURE ALL WATER USED DURING ASBESTOS ABATEMENT AND FILTER PRIOR TO DISCHARGE INTO MUNICIPAL WATER SYSTEM.

**LEGEND**

- ASBESTOS-CONTAINING PIPE AND/OR PIPE FITTING INSULATION ASSUMED TO BE PRESENT ABOVE CEILING OR WITHIN PIPE CHASE/WALL CAVITY
- ASBESTOS-CONTAINING PIPE FITTING INSULATION IN UTILITY TUNNEL
- APPROXIMATE LOCATION OF PIPE PENETRATIONS THROUGH CONCRETE SLAB FOR RADIATOR CONNECTIONS. ASBESTOS-CONTAINING PIPE INSULATION ASSUMED TO BE PRESENT

**LEGEND (CONTINUED)**

- ASBESTOS-CONTAINING PIPE AND/OR PIPE FITTING INSULATION ASSUMED TO BE PRESENT ABOVE CEILING OR WITHIN PIPE CHASE.
- ASBESTOS-CONTAINING PIPE AND/OR PIPE FITTING INSULATION ASSUMED TO BE PRESENT UNDER CONCRETE SLAB
- SUB-SLAB ASBESTOS-CONTAINING PIPE AND/OR PIPE FITTING INSULATION CONTAINED WITHIN CEMENT ASBESTOS TILE SLEEVE

**LEGEND (CONTINUED)**

- APPROXIMATE NUMBER OF PIPE FITTINGS WITH ASBESTOS-CONTAINING INSULATION
- APPROXIMATE QUANTITY (LINEAR FEET) OF ASBESTOS-CONTAINING PIPE INSULATION
- CONCRETE PIPE TRENCH WITH ASBESTOS-CONTAINING PIPE INSULATION DEBRIS

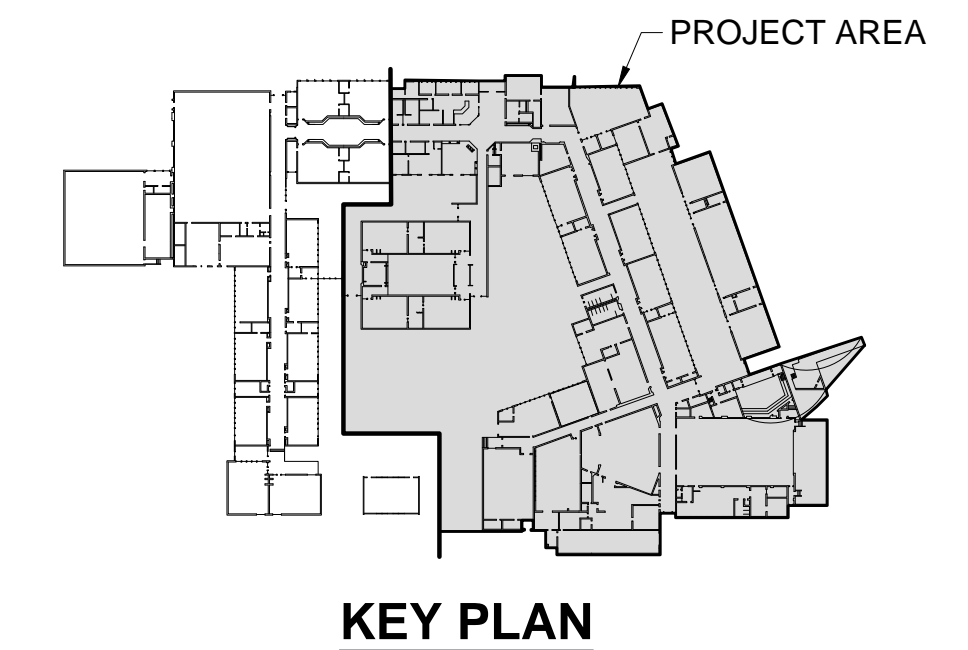

**PARTIAL FIRST FLOOR PLAN - THERMAL SYSTEM INSULATION**

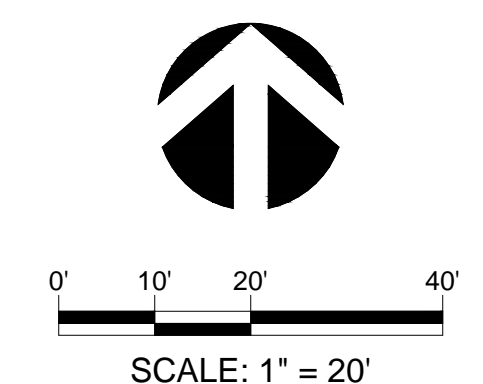

HAZARDOUS
MATERIAL
ABATEMENT
PLAN

PROJECT:	52141.003
DRAWN:	JAB
CHECKED:	JH
DATE:	JANUARY 2016

FIGURE:	SHEET:
HM5	5 OF 9

L:\Projects\52141\52141\_003\_01\01\01.dwg, 11/13/2015 10:10:10 AM, JAB



**GENERAL NOTES**

- THIS DRAWING IS DIAGRAMMATIC. IT IS FOR GENERAL INFORMATION.
- CONTRACTOR SHALL FIELD VERIFY ALL DIMENSIONS, MATERIAL QUANTITIES, ITEMS TO BE DEMOLISHED, AND ITEMS TO BE SAVED AND PROTECTED.
- CONTRACTOR SHALL BECOME KNOWLEDGEABLE WITH EXTRACTION POINT LOCATIONS AND LIMITATIONS, AND VERIFY ALL EXTRACTION POINT MEASUREMENTS IN THE FIELD.
- CONTRACTOR SHALL COORDINATE ALL WORK WITH THE OWNER INCLUDING BUT NOT LIMITED TO SCHEDULING, ACCESS, SECURITY, STAGING, PROTECT AND SAVE ITEMS, SALVAGE, LOCKOUT/TAGOUT, AND DEMOLITION ACTIVITIES.
- ALL CONTRACTORS AND SUB-CONTRACTORS PERFORMING ABATEMENT AND DEMOLITION TASKS ON PAINTED SURFACES SHALL COMPLY WITH ALL APPLICABLE LEAD PAINT REGULATIONS IN OAR 437-DIVISION 3, 1926.62 LEAD IN CONSTRUCTION STANDARD.
- CONTRACTOR SHALL REMOVE AND DISPOSE OF ALL BUILDING FINISHES, FURNISHINGS, CASEWORK, MECHANICAL EQUIPMENT, AND ALL OTHER OBSTRUCTIONS TO ACCESS ASBESTOS-CONTAINING MATERIALS TO BE REMOVED.
- CLEANUP AND DISPOSAL OF ALL GENERAL WASTE GENERATED AS A RESULT OF DEMOLITION ACTIVITIES SHALL BE THE RESPONSIBILITY OF THE CONTRACTOR.
- CONTRACTOR SHALL VERIFY WITH THE OWNER, SPECIFIC ITEMS TO BE SAVED AND PROTECTED PRIOR TO THE START OF ABATEMENT AND DEMOLITION WORK.
- PROTECT ALL SYSTEMS OUTSIDE THE SCOPE OF WORK OF THIS PROJECT FROM DAMAGE AS A RESULT OF WORK INCLUDED IN THIS PROJECT, AND PROTECT ALL ITEMS SPECIFICALLY INDICATED IN THESE SPECIFICATIONS.
- COORDINATE DISCONNECTION AND DE-ENERGIZING OF ALL OPERATIONAL COMPONENTS WITH OWNER PRIOR TO THE START OF ASBESTOS ABATEMENT AND DEMOLITION WORK.

**ABATEMENT NOTES**

- REMOVE AND DISPOSE OF ALL ASBESTOS-CONTAINING MATERIALS IDENTIFIED ON THE ABATEMENT DRAWINGS AND IN THE SECTION 01 11 00 SUMMARY OF WORK. DRAWINGS DO NOT SHOW ALL ASBESTOS-CONTAINING MATERIALS TO BE REMOVED. REFER TO THE ABATEMENT NOTES AND SUMMARY OF WORK SECTION 01 11 00 FOR ADDITIONAL DETAILS AND TASKS INCLUDED IN THE PROJECT SCOPE OF WORK.
- CEMENT ASBESTOS CHALKBOARDS ARE CONCEALED BEHIND NEWER WHITE BOARDS IN MOST LOCATIONS; HENCE, THE ACTUAL LOCATIONS OF SOME CEMENT ASBESTOS CHALKBOARDS SHOWN ON THE DRAWINGS MAY VARY WITHIN INDIVIDUAL ROOMS.
- SUB-SLAB CEMENT ASBESTOS PIPE LOCATIONS ARE APPROXIMATE.
- THE CONTRACTOR SHALL BE RESPONSIBLE FOR CLEANING OR REMOVAL AND DISPOSAL OF ANY ITEMS THAT BECOME CONTAMINATED AS A RESULT OF ASBESTOS ABATEMENT WORK.
- ALL ASBESTOS ABATEMENT AND ALL DEMOLITION WORK THAT MAY IMPACT ASBESTOS-CONTAINING MATERIALS SHALL BE CONDUCTED WITHIN A NEGATIVE PRESSURE ENCLOSURE.
- CONTRACTOR SHALL CAPTURE ALL WATER USED DURING ASBESTOS ABATEMENT AND FILTER PRIOR TO DISCHARGE INTO MUNICIPAL WATER SYSTEM.
- FIELD VERIFY ALL FLUORESCENT LIGHT FIXTURE BALLASTS AND REMOVE AND PROPERLY DISPOSE OF ALL BALLASTS THAT ARE NOT SPECIFICALLY LABELED AS NON-PCB. REMOVE AND PROPERLY RECYCLE ALL MERCURY VAPOR FLUORESCENT LIGHT TUBES. REMOVE AND PROPERLY DISPOSE OF ALL MERCURY-CONTAINING SWITCHES.

**LEGEND (THIS SHEET)**

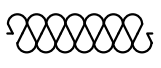
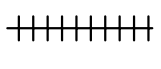
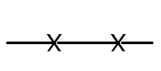
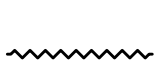
-  ASSUMED ASBESTOS-CONTAINING FIREDOOR
-  ASSUMED ASBESTOS-CONTAINING ROLLING FIREDOOR
-  CEMENT ASBESTOS CHALKBOARD
-  WINDOW UNITS WITH GLAZING COMPOUND CONTAINING <1% ASBESTOS
-  WINDOW UNITS WITH ASBESTOS-CONTAINING GLAZING COMPOUND

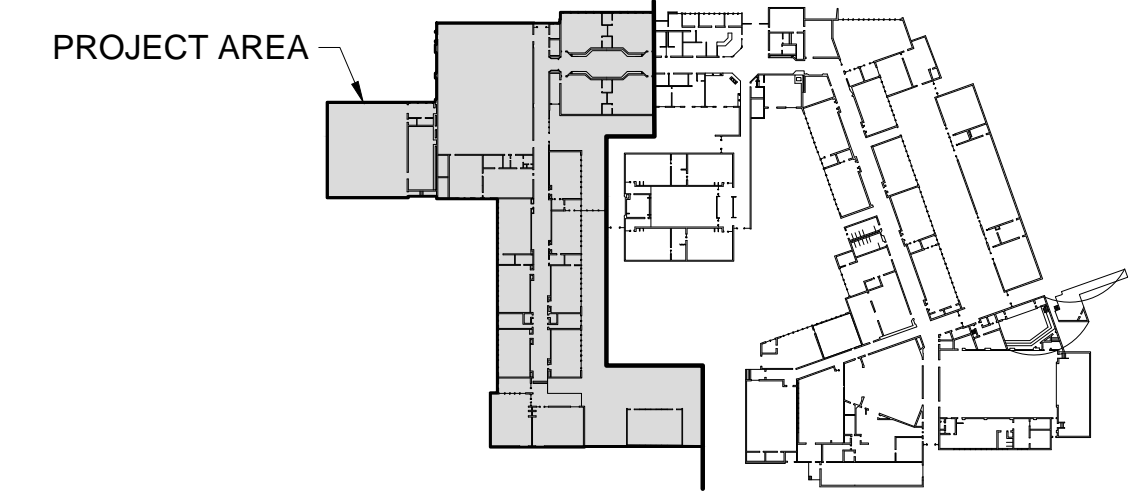

**KEY PLAN**



**PARTIAL FIRST FLOOR PLAN - MISCELLANEOUS MATERIALS**

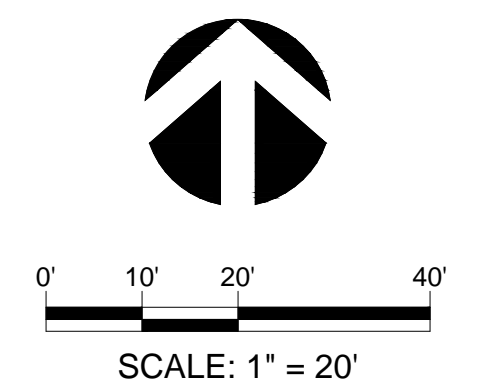

L:\Projects\52141\52141-00-01\0102.dwg - JAB - 12/15/2016 11:11am - jnh

**GENERAL NOTES**

- THIS DRAWING IS DIAGRAMMATIC. IT IS FOR GENERAL INFORMATION.
- CONTRACTOR SHALL FIELD VERIFY ALL DIMENSIONS, MATERIAL QUANTITIES, ITEMS TO BE DEMOLISHED, AND ITEMS TO BE SAVED AND PROTECTED.
- CONTRACTOR SHALL BECOME KNOWLEDGEABLE WITH EXTRACTION POINT LOCATIONS AND LIMITATIONS, AND VERIFY ALL EXTRACTION POINT MEASUREMENTS IN THE FIELD.
- CONTRACTOR SHALL COORDINATE ALL WORK WITH THE OWNER INCLUDING BUT NOT LIMITED TO SCHEDULING, ACCESS, SECURITY, STAGING, PROTECT AND SAVE ITEMS, SALVAGE, LOCKOUT/TAGOUT, AND DEMOLITION ACTIVITIES.
- ALL CONTRACTORS AND SUB-CONTRACTORS PERFORMING ABATEMENT AND DEMOLITION TASKS ON PAINTED SURFACES SHALL COMPLY WITH ALL APPLICABLE LEAD PAINT REGULATIONS IN OAR 437-DIVISION 3, 1926.62 LEAD IN CONSTRUCTION STANDARD.
- CONTRACTOR SHALL REMOVE AND DISPOSE OF ALL BUILDING FINISHES, FURNISHINGS, CASEWORK, MECHANICAL EQUIPMENT, AND ALL OTHER OBSTRUCTIONS TO ACCESS ASBESTOS-CONTAINING MATERIALS TO BE REMOVED.
- CLEANUP AND DISPOSAL OF ALL GENERAL WASTE GENERATED AS A RESULT OF DEMOLITION ACTIVITIES SHALL BE THE RESPONSIBILITY OF THE CONTRACTOR.
- CONTRACTOR SHALL VERIFY WITH THE OWNER, SPECIFIC ITEMS TO BE SAVED AND PROTECTED PRIOR TO THE START OF ABATEMENT AND DEMOLITION WORK.
- PROTECT ALL SYSTEMS OUTSIDE THE SCOPE OF WORK OF THIS PROJECT FROM DAMAGE AS A RESULT OF WORK INCLUDED IN THIS PROJECT, AND PROTECT ALL ITEMS SPECIFICALLY INDICATED IN THESE SPECIFICATIONS.
- COORDINATE DISCONNECTION AND DE-ENERGIZING OF ALL OPERATIONAL COMPONENTS WITH OWNER PRIOR TO THE START OF ASBESTOS ABATEMENT AND DEMOLITION WORK.

**ABATEMENT NOTES**

- REMOVE AND DISPOSE OF ALL ASBESTOS-CONTAINING MATERIALS IDENTIFIED ON THE ABATEMENT DRAWINGS AND IN THE SECTION 01 11 00 SUMMARY OF WORK. DRAWINGS DO NOT SHOW ALL ASBESTOS-CONTAINING MATERIALS TO BE REMOVED. REFER TO THE ABATEMENT NOTES AND SUMMARY OF WORK SECTION 01 11 00 FOR ADDITIONAL DETAILS AND TASKS INCLUDED IN THE PROJECT SCOPE OF WORK.
- CEMENT ASBESTOS CHALKBOARDS ARE CONCEALED BEHIND NEWER WHITE BOARDS IN MOST LOCATIONS; HENCE, THE ACTUAL LOCATIONS OF SOME CEMENT ASBESTOS CHALKBOARDS SHOWN ON THE DRAWINGS MAY VARY WITHIN INDIVIDUAL ROOMS.
- SUB-SLAB CEMENT ASBESTOS PIPE LOCATIONS ARE APPROXIMATE.
- THE CONTRACTOR SHALL BE RESPONSIBLE FOR CLEANING OR REMOVAL AND DISPOSAL OF ANY ITEMS THAT BECOME CONTAMINATED AS A RESULT OF ASBESTOS ABATEMENT WORK.
- ALL ASBESTOS ABATEMENT AND ALL DEMOLITION WORK THAT MAY IMPACT ASBESTOS-CONTAINING MATERIALS SHALL BE CONDUCTED WITHIN A NEGATIVE PRESSURE ENCLOSURE.
- CONTRACTOR SHALL CAPTURE ALL WATER USED DURING ASBESTOS ABATEMENT AND FILTER PRIOR TO DISCHARGE INTO MUNICIPAL WATER SYSTEM.
- FIELD VERIFY ALL FLUORESCENT LIGHT FIXTURE BALLASTS AND REMOVE AND PROPERLY DISPOSE OF ALL BALLASTS THAT ARE NOT SPECIFICALLY LABELED AS NON-PCB. REMOVE AND PROPERLY RECYCLE ALL MERCURY VAPOR FLUORESCENT LIGHT TUBES. REMOVE AND PROPERLY DISPOSE OF ALL MERCURY-CONTAINING SWITCHES.

**KEY NOTES**

- CEMENT ASBESTOS PANELS UNDER WINDOW UNIT.
- PRESUMED ASBESTOS-CONTAINING CHALKBOARDS AND MASTIC CONCEALED BEHIND WHITEBOARDS.
- ASBESTOS-CONTAINING SEALANT APPLIED AROUND METAL LOUVER OPENINGS.
- AIR HANDLING UNIT (MZ-2) WITH ASBESTOS-CONTAINING MASTIC ON INTERIOR SURFACES IN MECHANICAL PENTHOUSE.
- STAGE LIGHTS WITH ASBESTOS-CONTAINING WIRE INSULATION LOCATED ABOVE STAGE, STAGE CONTROL BOOTH LOFT AND ATTIC SPACE.
- ASBESTOS-CONTAINING GASKETS ASSUMED TO BE PRESENT AT PIPE FLANGE CONNECTIONS.

**LEGEND (THIS SHEET)**

- ASSUMED ASBESTOS-CONTAINING FIREDOOR
- ASSUMED ASBESTOS-CONTAINING ROLLING FIREDOOR
- CEMENT ASBESTOS CHALKBOARD
- APPROXIMATE LOCATION OF CEMENT ASBESTOS PIPE SLEEVE PENETRATION THROUGH CONCRETE SLAB

**LEGEND (THIS SHEET) (CONTINUED)**

- CEMENT ASBESTOS PIPE UNDER CONCRETE SLAB
- WINDOW UNITS WITH GLAZING COMPOUND CONTAINING <1% ASBESTOS
- GYPHUM BOARD WALLS AND SOFFITS WITH ASBESTOS-CONTAINING JOINT COMPOUND. SANDAL WOOD WAINSCOT ON LOWER WALLS WITH ASBESTOS-CONTAINING MASTIC

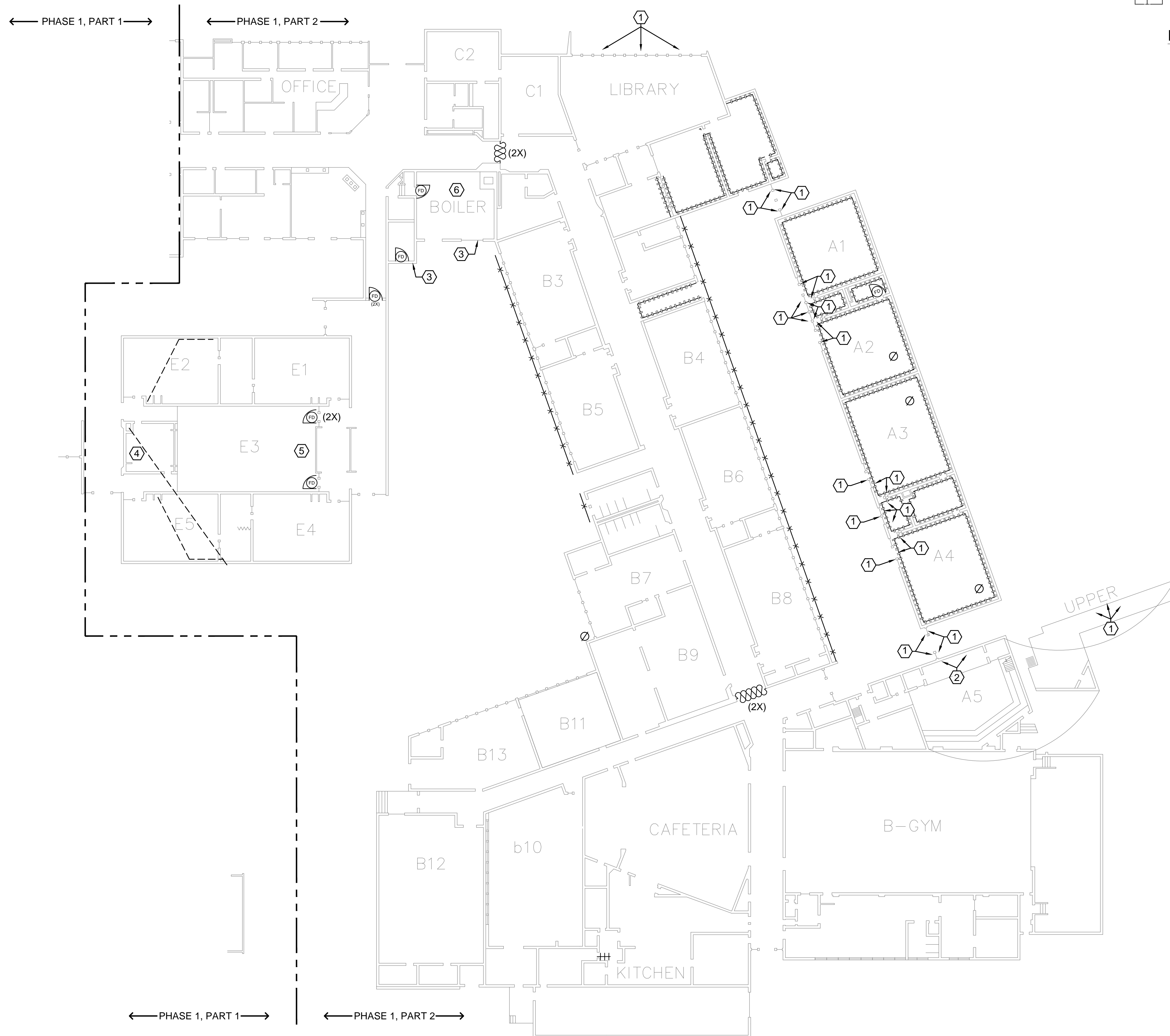

**PARTIAL FIRST FLOOR PLAN - MISCELLANEOUS MATERIALS**

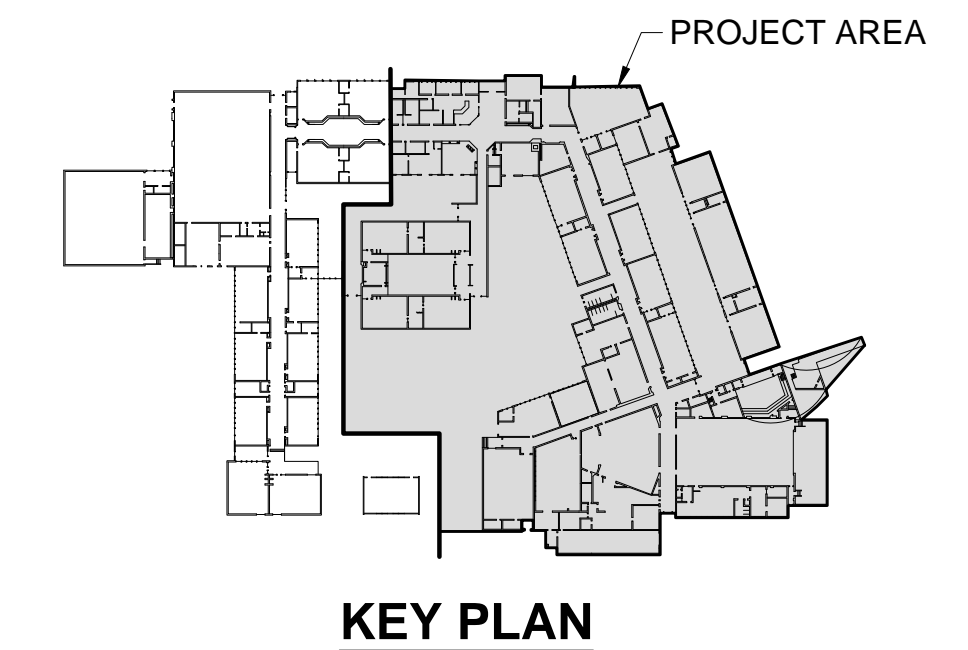

HAZARDOUS
MATERIAL
ABATEMENT
PLAN

PROJECT:	52141.003
DRAWN:	JAB
CHECKED:	JH
DATE:	JANUARY 2016

FIGURE:	7
SHEET:	OF 9

L:\Projects\52141\52141-01\52141-01.dwg, 13:20:16, 03/10/2016, JAB

**GENERAL NOTES**

1. THIS DRAWING IS DIAGRAMMATIC. IT IS FOR GENERAL INFORMATION.
2. CONTRACTOR SHALL FIELD VERIFY ALL DIMENSIONS, MATERIAL QUANTITIES, ITEMS TO BE DEMOLISHED, AND ITEMS TO BE SAVED AND PROTECTED.
3. CONTRACTOR SHALL BECOME KNOWLEDGEABLE WITH EXTRACTION POINT LOCATIONS AND LIMITATIONS, AND VERIFY ALL EXTRACTION POINT MEASUREMENTS IN THE FIELD.
4. CONTRACTOR SHALL COORDINATE ALL WORK WITH THE OWNER INCLUDING BUT NOT LIMITED TO SCHEDULING, ACCESS, SECURITY, STAGING, PROTECT AND SAVE ITEMS, SALVAGE, LOCKOUT/TAGOUT, AND DEMOLITION ACTIVITIES.
5. ALL CONTRACTORS AND SUB-CONTRACTORS PERFORMING ABATEMENT AND DEMOLITION TASKS ON PAINTED SURFACES SHALL COMPLY WITH ALL APPLICABLE LEAD PAINT REGULATIONS IN OAR 437-DIVISION 3, 1926.62 LEAD IN CONSTRUCTION STANDARD.
6. CONTRACTOR SHALL REMOVE AND DISPOSE OF ALL BUILDING FINISHES, FURNISHINGS, CASEWORK, MECHANICAL EQUIPMENT, AND ALL OTHER OBSTRUCTIONS TO ACCESS ASBESTOS-CONTAINING MATERIALS TO BE REMOVED.
7. CLEANUP AND DISPOSAL OF ALL GENERAL WASTE GENERATED AS A RESULT OF DEMOLITION ACTIVITIES SHALL BE THE RESPONSIBILITY OF THE CONTRACTOR.
8. CONTRACTOR SHALL VERIFY WITH THE OWNER, SPECIFIC ITEMS TO BE SAVED AND PROTECTED PRIOR TO THE START OF ABATEMENT AND DEMOLITION WORK.
9. PROTECT ALL SYSTEMS OUTSIDE THE SCOPE OF WORK OF THIS PROJECT FROM DAMAGE AS A RESULT OF WORK INCLUDED IN THIS PROJECT, AND PROTECT ALL ITEMS SPECIFICALLY INDICATED IN THESE SPECIFICATIONS.
10. COORDINATE DISCONNECTION AND DE-ENERGIZING OF ALL OPERATIONAL COMPONENTS WITH OWNER PRIOR TO THE START OF ASBESTOS ABATEMENT AND DEMOLITION WORK.

**ABATEMENT NOTES**

1. REMOVE AND DISPOSE OF ALL ASBESTOS-CONTAINING MATERIALS IDENTIFIED ON THE ABATEMENT DRAWINGS AND IN THE SECTION 01 11 00 SUMMARY OF WORK. DRAWINGS DO NOT SHOW ALL ASBESTOS-CONTAINING MATERIALS TO BE REMOVED. REFER TO THE ABATEMENT NOTES AND SUMMARY OF WORK SECTION 01 11 00 FOR ADDITIONAL DETAILS AND TASKS INCLUDED IN THE PROJECT SCOPE OF WORK.
2. REMOVE ALL VENTS, FLASHING, AND ALL OTHER ROOF-MOUNTED FIXTURES AS NECESSARY TO ACCESS CONCEALED ASBESTOS-CONTAINING ROOFING MATERIALS.
3. REMOVE AND DISPOSE OF ALL ROOFING MATERIALS AND ASSOCIATED INSULATION DOWN TO THE WOOD ROOF DECK IN THE AREAS INDICATED ON THE DRAWING.
4. REMOVE AND DISPOSE OF ALL ASBESTOS-CONTAINING ROOF PENETRATION SEALANTS APPLIED AT VARIOUS ROOF PENETRATIONS THROUGHOUT THE ENTIRE BUILDING.
5. THE CONTRACTOR SHALL BE RESPONSIBLE FOR CLEANING OR REMOVAL AND DISPOSAL OF ANY ITEMS THAT BECOME CONTAMINATED AS A RESULT OF ASBESTOS ABATEMENT WORK.
6. CONTRACTOR SHALL CAPTURE ALL WATER USED DURING ASBESTOS ABATEMENT AND FILTER PRIOR TO DISCHARGE INTO MUNICIPAL WATER SYSTEM.

**LEGEND**

 ASBESTOS-CONTAINING BUILT-UP ROOFING

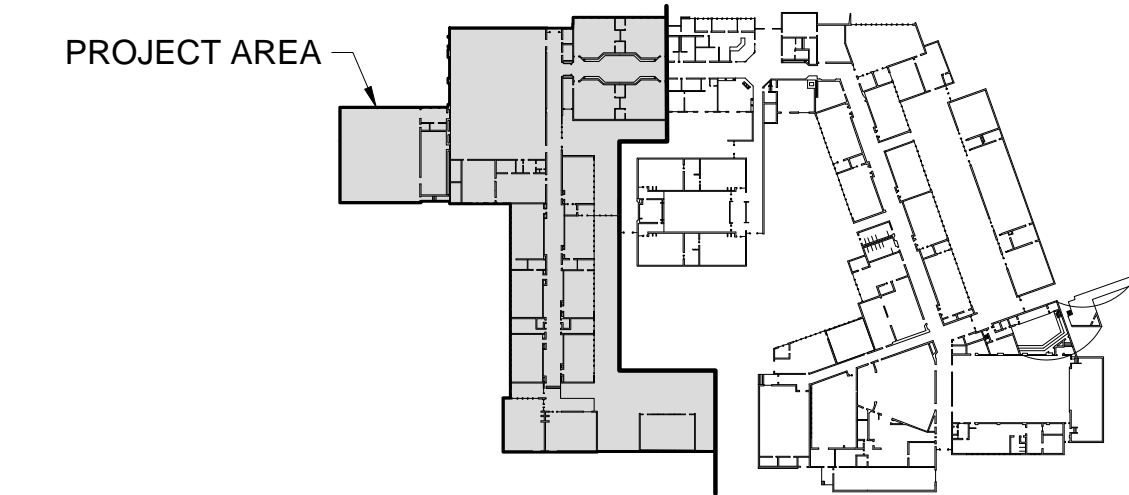

**KEY PLAN**



**PARTIAL ROOF PLAN**

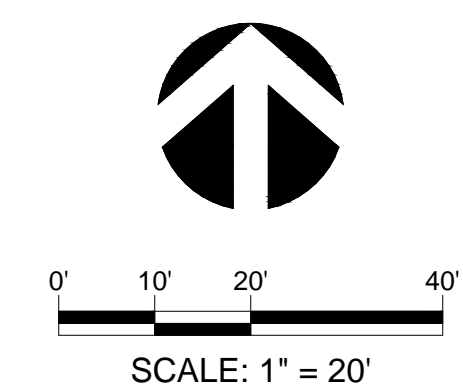

HAZARDOUS
MATERIAL
ABATEMENT
PLAN

PROJECT:	52141.003
DRAWN:	JAB
CHECKED:	JH
DATE:	JANUARY 2016

FIGURE:	8
SHEET:	OF 9

L:\Projects\2016\24th St\24th St Survey\DWG\Abatement\24th MS\_HM8.dwg, Jan 12, 2016 03:01 pm, jmh



**GENERAL NOTES**

1. THIS DRAWING IS DIAGRAMMATIC. IT IS FOR GENERAL INFORMATION.
2. CONTRACTOR SHALL FIELD VERIFY ALL DIMENSIONS, MATERIAL QUANTITIES, ITEMS TO BE DEMOLISHED, AND ITEMS TO BE SAVED AND PROTECTED.
3. CONTRACTOR SHALL BECOME KNOWLEDGEABLE WITH EXTRACTION POINT LOCATIONS AND LIMITATIONS, AND VERIFY ALL EXTRACTION POINT MEASUREMENTS IN THE FIELD.
4. CONTRACTOR SHALL COORDINATE ALL WORK WITH THE OWNER INCLUDING BUT NOT LIMITED TO SCHEDULING, ACCESS, SECURITY, STAGING, PROTECT AND SAVE ITEMS, SALVAGE, LOCKOUT/TAGOUT, AND DEMOLITION ACTIVITIES.
5. ALL CONTRACTORS AND SUB-CONTRACTORS PERFORMING ABATEMENT AND DEMOLITION TASKS ON PAINTED SURFACES SHALL COMPLY WITH ALL APPLICABLE LEAD PAINT REGULATIONS IN OAR 437-DIVISION 3, 1926.62 LEAD IN CONSTRUCTION STANDARD.
6. CONTRACTOR SHALL REMOVE AND DISPOSE OF ALL BUILDING FINISHES, FURNISHINGS, CASEWORK, MECHANICAL EQUIPMENT, AND ALL OTHER OBSTRUCTIONS TO ACCESS ASBESTOS-CONTAINING MATERIALS TO BE REMOVED.
7. CLEANUP AND DISPOSAL OF ALL GENERAL WASTE GENERATED AS A RESULT OF DEMOLITION ACTIVITIES SHALL BE THE RESPONSIBILITY OF THE CONTRACTOR.
8. CONTRACTOR SHALL VERIFY WITH THE OWNER, SPECIFIC ITEMS TO BE SAVED AND PROTECTED PRIOR TO THE START OF ABATEMENT AND DEMOLITION WORK.
9. PROTECT ALL SYSTEMS OUTSIDE THE SCOPE OF WORK OF THIS PROJECT FROM DAMAGE AS A RESULT OF WORK INCLUDED IN THIS PROJECT, AND PROTECT ALL ITEMS SPECIFICALLY INDICATED IN THESE SPECIFICATIONS.
10. COORDINATE DISCONNECTION AND DE-ENERGIZING OF ALL OPERATIONAL COMPONENTS WITH OWNER PRIOR TO THE START OF ASBESTOS ABATEMENT AND DEMOLITION WORK.

**ABATEMENT NOTES**

1. REMOVE AND DISPOSE OF ALL ASBESTOS-CONTAINING MATERIALS IDENTIFIED ON THE ABATEMENT DRAWINGS AND IN THE SECTION 01 11 00 SUMMARY OF WORK. DRAWINGS DO NOT SHOW ALL ASBESTOS-CONTAINING MATERIALS TO BE REMOVED. REFER TO THE ABATEMENT NOTES AND SUMMARY OF WORK SECTION 01 11 00 FOR ADDITIONAL DETAILS AND TASKS INCLUDED IN THE PROJECT SCOPE OF WORK.
2. REMOVE ALL VENTS, FLASHING, AND ALL OTHER ROOF-MOUNTED FIXTURES AS NECESSARY TO ACCESS CONCEALED ASBESTOS-CONTAINING ROOFING MATERIALS.
3. REMOVE AND DISPOSE OF ALL ROOFING MATERIALS AND ASSOCIATED INSULATION DOWN TO THE WOOD ROOF DECK IN THE AREAS INDICATED ON THE DRAWING.
4. REMOVE AND DISPOSE OF ALL ASBESTOS-CONTAINING ROOF PENETRATION SEALANTS APPLIED AT VARIOUS ROOF PENETRATIONS THROUGHOUT THE ENTIRE BUILDING.
5. THE CONTRACTOR SHALL BE RESPONSIBLE FOR CLEANING OR REMOVAL AND DISPOSAL OF ANY ITEMS THAT BECOME CONTAMINATED AS A RESULT OF ASBESTOS ABATEMENT WORK.
6. CONTRACTOR SHALL CAPTURE ALL WATER USED DURING ASBESTOS ABATEMENT AND FILTER PRIOR TO DISCHARGE INTO MUNICIPAL WATER SYSTEM.

**LEGEND**

 ASBESTOS-CONTAINING BUILT-UP ROOFING

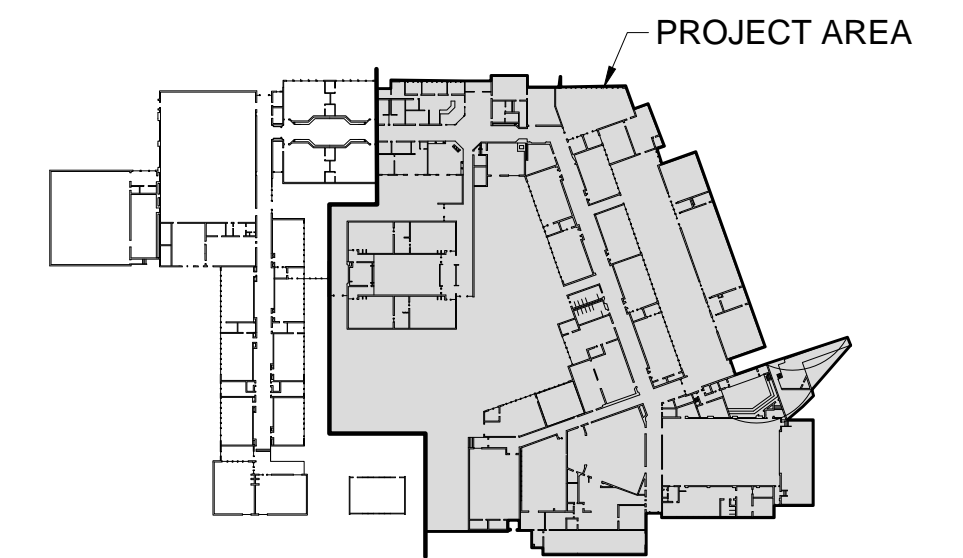

**KEY PLAN**



**PARTIAL ROOF PLAN**

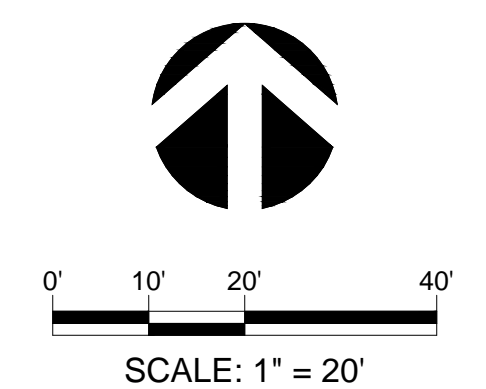

HAZARDOUS
MATERIAL
ABATEMENT
PHASING PLAN

PROJECT:	52141.003
DRAWN:	JAB
CHECKED:	JH
DATE:	JANUARY 2016

FIGURE:	SHEET:
HM9	9 OF 9

L:\Projects\52000\52141\_003\52141\_003\_Roosevelt MS Survey\DWG\Abatement\52141\_003\_HM9.dwg, Jan 12, 2016 03:02pm, jmh